

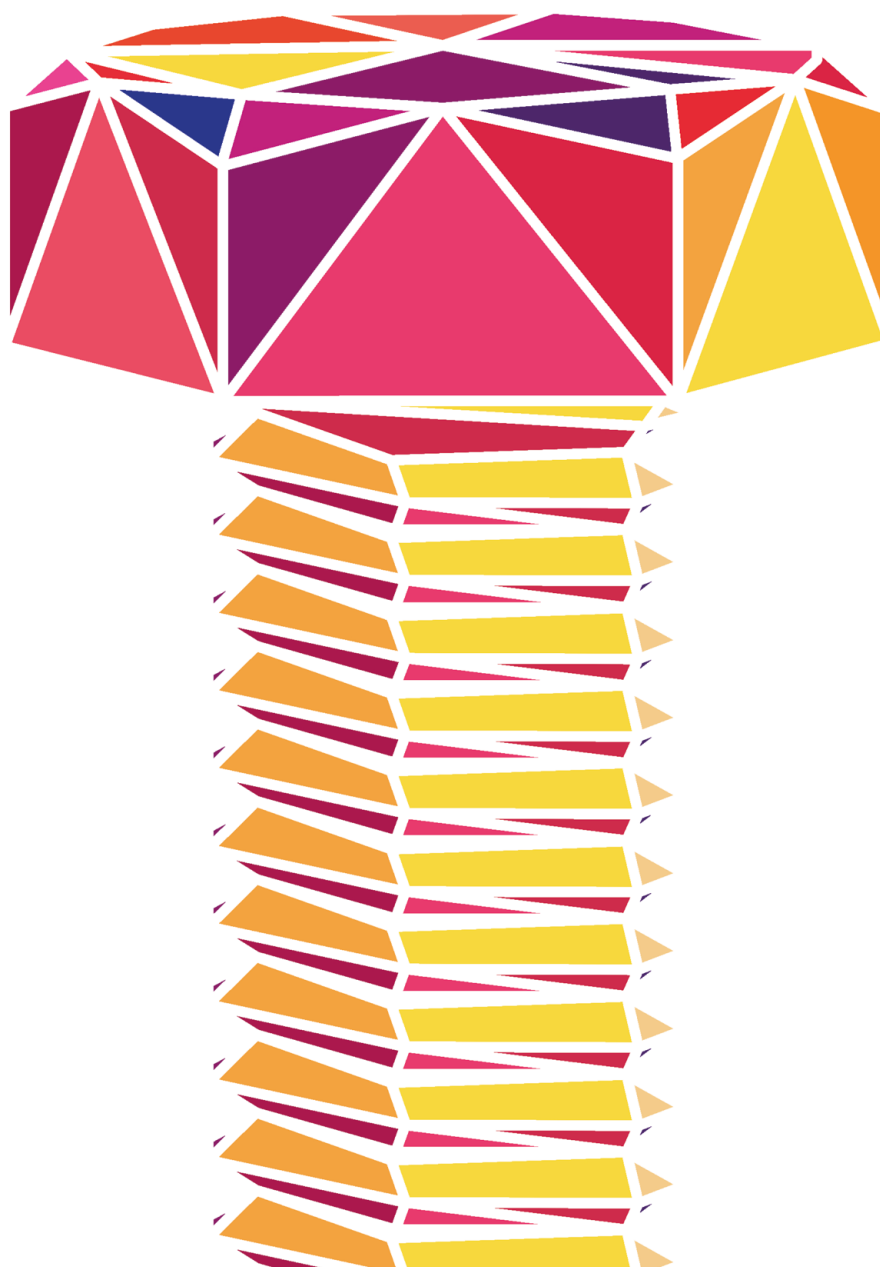

CATÁLOGO GENERAL 2024

EL CATÁLOGO MÁS COMPLETO DE TORNILLERÍA



# Todo nuestro catálogo

**Disponible**



# [www.matriu.es](http://www.matriu.es)



Pol. Ind. La Pascualeta  
Pascualeta, 27-29-31  
PAIPORTA, Valencia 46200  
(España)  
[comercial@matriu.es](mailto:comercial@matriu.es)  
T.: +34 963 973 718  
F.: +34 963 971 815

ISO 9001

BUREAU VERITAS  
Certification

ES095919-1





Bureau Veritas Certification



## Certificación

Concedida a

**MATRIU SL**

P.I. LA PASCUALETA, C/ PASCUALETA, 27-29 - 46200 - PAIPORTA -  
VALENCIA - ESPAÑA

Bureau Veritas Certification certifica que el Sistema de Gestión ha sido auditado y  
encontrado conforme con los requisitos de la norma:

NORMA

**ISO 9001:2015**

El Sistema de Gestión se aplica a:

**FABRICACIÓN Y COMERCIALIZACIÓN DE TORNILLERÍA  
ESTAMPADA. COMERCIALIZACIÓN DE TUERCAS,  
ARANDELAS, HERRAJES PARA MUEBLES Y  
ACCESORIOS PARA SISTEMAS DE ELEVACIÓN.**

Número del Certificado:	ES121870-1
Aprobación original:	30-06-2003
Auditoría de certificación/renovación:	11-06-2021
Caducidad de ciclo anterior:	21-06-2021
Certificado en vigor:	24-06-2021
Caducidad del certificado:	21-06-2024

*Este certificado está sujeto a los términos y condiciones generales y particulares de los servicios de certificación*

Bureau Veritas Iberia S.L.  
C/ Valporlillo Primera 22-24, Edificio Caoba, 28108 Alcobendas - Madrid, España



Garantía de Calidad



# DESCUBRE NUESTROS

## AMPLIAMOS NUESTRA CAPACIDAD DE ALMACENAJE

Nuestros nuevos almacenes de trilateral cuentan con más de 9.000 ubicaciones de pallet europeo, llegando a duplicar nuestra capacidad de almacenamiento hasta la fecha.

# NUEVOS ALMACENES

## OPTIMIZAMOS NUESTROS PROCESOS

La carretilla trilateral permite optimizar el proceso de almacenaje, al permitir acceder a las ubicaciones de ambos lados del pasillo sin necesidad de maniobrar optimizando el número de pallets almacenados por minuto.

**Tu almacenamiento,  
nuestro compromiso.**



## Fabricación y personalización

Con nuestra experiencia de más de 45 años en todos los sectores industriales, fabricamos cualquier pieza especial de tornillería, bajo plano y/o muestra del cliente.

Con nuestra maquinaria moderna y nuestros profesionales aseguramos el control de calidad en todo el proceso productivo.

Matrickería disponible para diámetros:

- Rosca métrica: M3 - M14
- Rosca madera: 2,5 - 10
- Rosca chapa: 2,9 - 6,3
- Consulte otras medidas

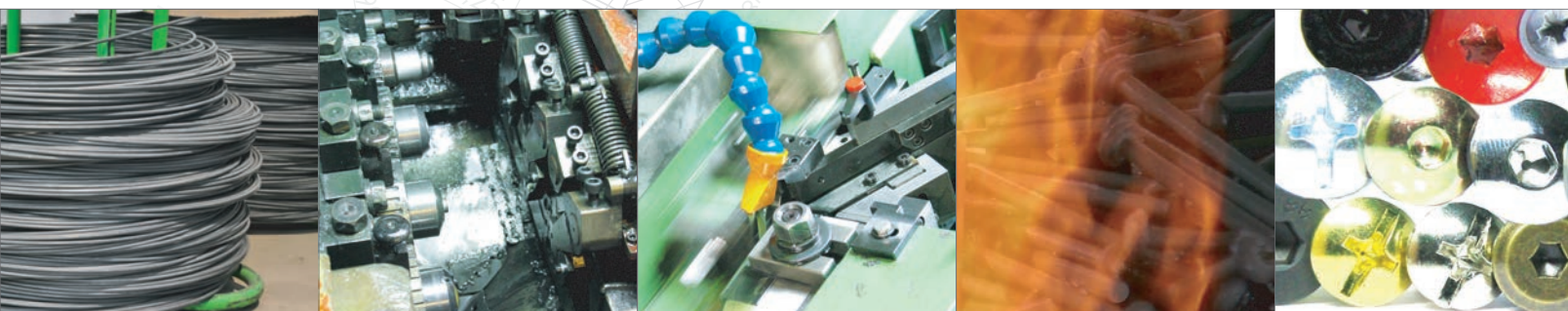

**Eficiencia**

**Calidad**

**Productividad**

**Automatización**

**Control de calidad**

**Optimización**

**Fidelización**

**Prospección**

**Retroalimentación**

**Calidad del servicio**

**Atención al cliente**

**Satisfacción del cliente**

**Mejora continua**



Observaciones  
Cotas en mm. Las cotas sin tolerancia especifica se le  
aplica una tolerancia general según la norma 286  
Cliente



## CINCADO CR3+



Recubrimiento de un sustrato metálico con una capa brillante de Cinc Alcalino depositado electrolíticamente. Tiene como finalidad la proteger la pieza de la corrosión.

Recubrimiento electrolítico de Cinc Alcalino + pasivado negro que le proporciona su característico color. Acabado brillo. A mismo espesor de capa se consigue un resistencia a la corrosión mayor que en el acabado cincado. Aplicándole Top Coat se pueden conseguir distintos acabados mate/brillo.



## CINC NEGRO CR3+



Recubrimiento metálico de níquel mediante aplicación de un proceso electrolítico, que mejora la resistencia a la oxidación y el aspecto de las piezas. No presenta fragilización por hidrogenación en tornillos de alta resistencia.



## NIQUELADO

Revestimiento electrolítico que se deposita sobre una capa previa de níquel. Se caracteriza por sus excelentes propiedades anticorrosivas, incrementa la dureza y disminuye los coeficientes de rozamiento entre piezas. Muy utilizado con fines estéticos debido a su acabado muy brillante.



## CROMADO



Revestimiento electrolítico que se deposita sobre una capa previa de níquel. Mejora la resistencia a la corrosión y al desgaste. Se suele utilizar con fines decorativos debido a su color y su brillo.



## LATONADO BRILLO

Recubrimiento electrolítico sustituto del tradicional Bicromatado, a diferencia de su antecesor éste está exento de Cr VI. A mismo espesor de capa tiene mejores propiedades anticorrosivas que el cincado negro.



## CINCADO AMARILLO CR3+



Revestimiento de base acuosa compuesto de láminas de Cinc y de aluminio unidas por un ligante inorgánico. Recomendado para tornillería de alta resistencia ya que por las características del proceso no presenta fragilización por hidrogenación. Proporciona una alta resistencia a la corrosión.



## LAMINAS DE CINC-ALUMINIO



Tratamiento latonado al que se le aplica una oxidación química para conseguir un aspecto envejecido. Se descubre el latón y se laca.



## CUERO





Aplicación de una laca sobre el tornillo. Puede aplicarse a todo el tornillo o solamente a la cabeza. La gran variedad de RAL disponible permite la personalización para cualquier uso decorativo. Disponible en acabado MATE o BRILLO.



## LACADOS RAL



## LATÓN VIEJO



Sustituto del acabado cuero. Se aplica inicialmente un latonado seguido de una oxidación química que lo oscurece. Posteriormente se revela el color latón de la capa interior y se laca. Pueden conseguirse diferentes tonalidades.

Baño electrolítico de cobre al que posteriormente se le aplica un proceso de oxidación química para oscurecerlo. Por último se revela el característico color rojizo del cobre y se laca.

## COBRE VIEJO



## BRONCE BLANCO



También conocido como Níquel Free es el utilizado para sustituir los recubrimientos de níquel en los casos en los que la normativa aplicable no permite su uso, como por ejemplo aquellos usos en los que exista contacto con la piel del usuario.

La aleación de Cinc y Níquel utilizada para este recubrimiento electrolítico otorga una elevada resistencia a la corrosión. Muy utilizado en el sector de la automoción debido a su estabilidad a altas temperaturas.

## CINC NÍQUEL INCOLORO



## CINC NÍQUEL NEGRO



La aleación de Cinc y Níquel utilizada para este recubrimiento electrolítico otorga una elevada resistencia a la corrosión. Pasivado para darle su característico color negro. Si posteriormente se le aplica Top Coat se pueden conseguir distintos acabados mate/brillo

Capa adicional que se aplica a los recubrimientos electrolíticos para mejorar sus propiedades anticorrosivas.

## TOP COAT



## SELLANTE TIPO PATCH



Se aplica poliamida 11 en la rosca del tornillos para que ejerza una función autoblocante mediante su par de apriete correspondiente.

**Personalizamos  
tus proyectos.**





### MODO DE EFECTUAR UN PEDIDO.

A través de nuestra web: [www.matriu.es](http://www.matriu.es)

Por correo electrónico a: [pedidos@matriu.es](mailto:pedidos@matriu.es)

Por fax: + 34 96 397 18 15.

### DISPONIBILIDAD DEL PRODUCTO Y PLAZO DE ENTREGA.

Todos los materiales representados en el presente Catálogo General 2024 se encuentran en stock, salvo aquellos supuestos en los que, bien por venta de los mismos, bien por otra circunstancia, no se hallaren en tal situación, en cuyo caso, MATRIU, S.L. podrá o no atender el pedido realizado por el CLIENTE, previa comunicación al mismo.

En caso de existencia de stock, el plazo de entrega será inmediato, entendiéndose el mismo, entre uno y diez días desde la fecha de confirmación del pedido por parte del CLIENTE, y de su aceptación por parte de MATRIU, S.L., sin perjuicio de las demoras que por cualquiera causa ajena a MATRIU, S.L. pudieran originarse.

### FORMA DE ENTREGA:

La entrega de la mercancía se realizará, como norma general, a PORTES DEBIDOS salvo pacto en contrario.

### PEDIDO MÍNIMO:

Se establece un **pedido mínimo de 50 EUROS** por pedido realizado, que podrá ser modificado por MATRIU, S.L. por circunstancias productivas; en el caso de tratarse de un importe inferior al fijado como pedido mínimo, se requerirá al cliente para que aumente su pedido hasta alcanzar dicho importe, no sirviéndose el pedido hasta que ello ocurra. Transcurridos 5 días desde el requerimiento por parte de MATRIU, S.L. sin que el CLIENTE haya realizado dicho aumento, se procederá a la ANULACIÓN del pedido.

### CONDICIONES DE PAGO.

La forma de pago de las facturas emitidas por MATRIU, S.L. será, como norma general para nuevos clientes:

1. Las TRES primeras compras, a la confirmación del pedido, mediante pago en metálico o transferencia bancaria previa, realizándose un descuento por pronto pago de 2 %.
2. Los siguientes pedidos, mediante elección de una de las formas de pago siguientes:
  - a. Pago contado en metálico o transferencia bancaria previa a la confirmación del pedido, con un descuento del 2% por pronto pago.
  - b. Pago a 10 días fecha factura, sin día de pago, mediante transferencia bancaria.
  - c. Pago a 30 días fecha factura sin día de pago, mediante giro bancario domiciliado.

### RECLAMACIONES Y POLÍTICA DE DEVOLUCIÓN DE MERCANCÍA.

En los supuestos de devolución de mercancía por causa ajena a MATRIU, S.L., se deben cumplir los siguientes requisitos:

1. El material objeto de la devolución debe encontrarse empaquetado en caja original de MATRIU, S.L. con su correspondiente etiqueta original identificativa. El empaquetado debe tener las mismas condiciones que cuando fue entregado.
2. El embalaje debe conservar el precinto original de MATRIU, S.L.
3. La mercancía no debe haber sido manipulada previamente.
4. Debe adjuntarse a nuestro departamento de atención al cliente (attcliente@matriu.es) el albarán o copia del mismo donde conste dicha mercancía, así como fotografía/s de la misma.
5. Que no hayan transcurrido más de 7 días desde la recepción de la mercancía.

En todo caso, corresponderá a MATRIU, S.L. la aceptación de dicha mercancía, aún cumpliendo todos los requisitos anteriores.

Los supuestos de devolución por causas ajenas a MATRIU, S.L. conllevarán un cargo por manipulación del VEINTE POR CIENTO del importe total del material devuelto, con un fijo de VEINTE EUROS si el importe de la devolución no supera dicha cuantía, siempre y cuando sea aceptada dicha devolución por MATRIU, S.L. y la devolución cumpla todos los requisitos mencionados con anterioridad (puntos 1 a 5).

No se admitirán devoluciones de material fuera de catálogo, producto no estándar o reprocesados.

### PIEZAS ESPECIALES.

Las piezas especiales que aparecen en el presente catálogo son meramente enunciativas. Los precios de las mismas, serán ofertados mediante consulta previa del cliente.

La compra efectuada por el CLIENTE de cualquier producto suministrado por MATRIU, S.L., esté o no representado en el presente CATÁLOGO GENERAL, manifiesta que el mismo entiende y acepta las condiciones generales de venta aquí reseñadas, sin perjuicio de las posibles condiciones particulares que pudieran ser pactadas entre el CLIENTE y MATRIU, S.L.

Consiga su expositor **KaT**® para su establecimiento.  
Gratis\* con la compra de tornillería **KaT**®

\* Consulte condiciones especiales y personalización óptima para su negocio.



01	TORNILLOS ROSCA MADERA	23
02	TORNILLOS ROSCA MÉTRICA	53
03	TORNILLOS ROSCA MÉTRICA TRILOBULAR	129
04	TORNILLOS ROSCA PLÁSTICO	135
05	TORNILLOS ROSCA CHAPA, PARA CUBIERTAS Y HORMIGÓN	145
20	TORNILLOS PVC	169
06	TORNILLOS DE PLÁSTICO	173
07	TUERCAS	179
08	ARANDELAS	197
09	TACOS, ANCLAJES Y BRIDAS DE NYLON	209
10	COMPLEMENTOS DE PLÁSTICO	229
11	COMPLEMENTOS METÁLICOS	239
12	REMACHES Y PASADORES	261
13	PUNTAS Y ÚTILES PARA ATORNILLAR	271
15	CADENA, ACCESORIOS PARA CABLES Y ELEMENTOS DE ELEVACIÓN	277

**01 TORNILLOS ROSCA MADERA**

0101 DIN 7505-A 24

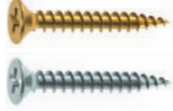

0103 DIN 7505-B 26



0104 KAT POZI 29



0105 KAT POZI PICKING 31



0107 KAT STAR 33



0108 KAT STAR PLUS ANTICORROSIÓN 35



0109 KAT STAR EMBELLECEDOR 35



0146 KAT STAR CON ARANDELA 36



0106 KAT POZI NEX 39



0141 KAT STAR DM 39



0112 TORNILLO TRASERA 40



0113 TORNILLO TRASERA ESTRIADO 40



0139 TORNILLO ROSCA MADERA CON ARANDELA ESTRIADA ALLEN 41



0125 TORNILLO ROSCA AGLOMERADO GOTA SEBO PHILIPS 41



0114 TORNILLO MANIVELA 42



0111 TORNILLO UNIÓN COCINA 42



0117 TORNILLO ENSAMBLAJE ALLEN ROSCA GOLOSA CON PUNTA 43

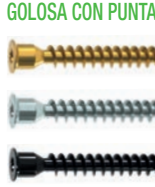

0118 TORNILLO EMBELLECEDOR ALLEN ROSCA GOLOSA SIN PUNTA 43



0116 TORNILLO ENSAMBLAJE ALLEN ROSCA GOLOSA SIN PUNTA 44



0119 TORNILLO ENSAMBLAJE ALLEN ROSCA GOLOSA CAB. AVELLANADA SIN PUNTA 45



0115 TORNILLO ENSAMBLAJE ALLEN ROSCA 1/4" SIN PUNTA 45



0133 TORNILLO ENGANCHE SIN PUNTA 46



0140 TORNILLO ENGANCHE CON PUNTA 46



0134 TORNILLO EURO 46



0135 TORNILLO EURO ROSCA PLÁSTICO 46



0120 DIN 571 47



0121 DIN 571 CALIDAD 8.8 48



0122 DIN 571 CON ARANDELA CALIDAD 8.8 48



0138 TORNILLO INVOLABLE 49



0126 ESPÁRRAGO DOWEL 49



0127 ESPÁRRAGO DOWEL CON HEXÁGONO 50



0129 ESPÁRRAGO ROSCA MADERA 50



0130 ESPÁRRAGO DOBLE ROSCA MADERA 50



0131 ESPÁRRAGO DOBLE ROSCA MADERA CON HEXÁGONO 50



0136 TORNILLO ABRAZADERA 51

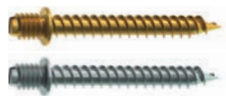

0123 DIN 96 51



0137 TORNILLO ROSCA AGLOMERADO RANURADO 52



0124 DIN 97 52





## 02 TORNILLOS ROSCA MÉTRICA

0201 DIN 603 CON  
TUERCA DIN 934



54

0202 DIN 603  
SIN TUERCA



55

0201 DIN 603 CON  
TUERCA DIN 934



56

0202 DIN 603  
SIN TUERCA



56

0203 DIN 603 SOMIER  
SIN TUERCA



57

0204 DIN 608 CALIDAD 6.8  
CON TUERCA DIN 934



57

0268 DIN 608 CALIDAD 8.8  
CON TUERCA DIN 934



57

0205 DIN 933



58

0206 DIN 933 CALIDAD 8.8



60

0273 DIN 933 CALIDAD 10.9



66

0207 DIN 931 CALIDAD 8.8



70

0274 DIN 931 CALIDAD 10.9



74

0208 DIN 6921 CALIDAD 8.8



78

0209 DIN 912 CALIDAD 8.8



79

0272 DIN 912 CALIDAD 12.9



83

0210 DIN 7984 CALIDAD 8.8



85

0211 ISO 10642  
(DIN 7991) CALIDAD 8.8



86

0212 ISO 10642 (DIN 7991)  
CALIDAD 10.9



88

0213 ISO 7380 CALIDAD 10.9



92

0214 ISO 7380-2 CON  
ARANDELA CALIDAD 10.9



94

0279 TORNILLO ALLEN  
SETA ESTRIADO CALIDAD 10.9



95

0215 TORNILLO ALLEN  
SETA ESTRIADO PERFIL  
ALTO CALIDAD 8.8



95

0217 DIN 913



96

0218 DIN 914



97

0219 VARILLA ROSCADA 1 m.



98

0220 VARILLA ROSCADA 1 m. 8.8



98

0221 VARILLA ROSCADA



100

0222 VARILLA ROSCADA PHILIPS



101

0223 MANGUITO  
ROSCADO HEXAGONAL



101

0224 MANGUITO  
ROSCADO CILÍNDRICO



102

0276 MANGUITO  
ROSCADO CILÍNDRICO



102

0225 TUBO UNIÓN 1/4"  
SIN TORNILLO



102

0226 TUBO UNIÓN 1/4"  
CON 2 TORNILLOS ENSAMBLE  
1/4" x 10



103

0227 TUBO UNIÓN 1/4"  
CON 2 TORNILLOS ENSAMBLE  
1/4" x 15



104

0227 TUBO UNIÓN 1/4"  
CON 2 TORNILLOS ENSAMBLE  
1/4" x 15



104



0228 HEMBRA ALLEN 4

105



0229 HEMBRA ALLEN 5

105



0230 HEMBRA ALLEN  
CABEZA PLANA

105



0231 HEMBRA COMBI  
PHILIPS RANURA

106



0232 HEMBRA GRAFILADA

106



0233 HEMBRA GRAFILADA  
CON ARANDELA

107



0286 TORNILLO TIRADOR CON ARANDELA



107

0234 HEMBRAS ESPECIALES



107

0235 TORNILLO TIRADOR



108

0236 TORNILLO TIRADOR FRACCIONADO



109

0237 TORNILLO SILLA 3/16"



109

0238 TORNILLO EMBELLECEDOR CABEZA PLANA ALLEN



109

0239 TORNILLO EMBELLECEDOR ALLEN



110

0242 TORNILLO ENSAMBLE COMBI CUNA



111

0240 TORNILLO ENSAMBLE COMBI



112

0241 TORNILLO ENSAMBLE DOBLE RANURA



113

0278 TORNILLO EMBELLECEDOR DOBLE RANURA



114

0244 DIN 7985 PH



115

0245 DIN 7985 STAR



116

0246 DIN 965 PH



117

0247 DIN 965 STAR



118

0248 DIN 966



112

0249 TORNILLO PHILIPS CON ARANDELA ESTRIADO 8.8



0250 TORNILLO PHILIPS CON ARANDELA ESTRIADO 6.8



113

0251 DIN 963



112

0252 DIN 86

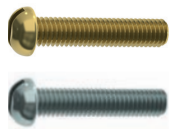

122

0253 DIN 84



124

0254 TORNILLO MARIPOSA



124

0255 TORNILLO VIOLA SIN ARANDELA



125

0256 TORNILLO CASCABEL CON TUERCA Y ARANDELA



118

0257 TORNILLO CASCABEL SIN TUERCA Y CON ARANDELA



126

0258 TORNILLO CASCABEL SIN TUERCA Y SIN ARANDELA



126

0259 TORNILLO CAMA CON TUERCA Y CON ARANDELA



127

0260 TORNILLO CAMA SIN TUERCA Y CON ARANDELA



127

0261 TORNILLO CAMA SIN TUERCA Y SIN ARANDELA



128

### 03 TORNILLOS ROSCA MÉTRICA TRILOBULAR

0301 DIN 7500 FORMA M POZI 130



122

0302 DIN 7500 FORMA C POZI 131



122

0303 DIN 7500 FORMA M STAR 132



124

0304 DIN 7500 FORMA C STAR 133



124

### 04 TORNILLOS ROSCA PLÁSTICO

0401 TORNILLO ROSCA PLÁSTICO 30° CABEZA PLANA POZI 136



125

0402 TORNILLO ROSCA PLÁSTICO 30°  
CABEZA CON ARANDELA POZI 137



0403 TORNILLO ROSCA PLÁSTICO  
30° CABEZA ALOMADA POZI 138



0404 TORNILLO ROSCA PLÁSTICO  
30° CABEZA PLANA STAR 139



0405 TORNILLO ROSCA PLÁSTICO  
30° CABEZA CON ARANDELA STAR 139



0406 TORNILLO ROSCA PLÁSTICO  
30° CABEZA ALOMADA STAR 140



0407 TORNILLO ROSCA PLÁSTICO  
45° CABEZA  
PLANA POZI TRILOBULAR 141



0408 TORNILLO ROSCA PLÁSTICO  
45° CABEZA CON ARANDELA POZI  
TRILOBULAR 141



0409 TORNILLO ROSCA PLÁSTICO  
45° CABEZA ALOMADA POZI  
TRILOBULAR 142



0410 TORNILLO ROSCA PLÁSTICO  
45° CABEZA PLANA STAR  
TRILOBULAR 143



0411 TORNILLO ROSCA PLÁSTICO  
45° CABEZA ALOMADA STAR  
TRILOBULAR 144



**05 TORNILLOS ROSCA  
CHAPA, PARA CUBIERTAS  
Y HORMIGÓN**

0501 DIN 7981 PH 146



0516 DIN 7981 STAR 147



0515 DIN 7981 PZ TIPO F 148



0502 DIN 7982 PH 149



0503 DIN 7983 PH 150



0523 TORN. R/CHAPA HEX. C/ARAN.  
ESTAMP. (DIN 6928 SIMILAR) 151



0525 TORN. R/CHAPA HEX. C/ARAN.  
ESTAMP. (DIN 6928 SIMILAR)  
+ EPDM 16 151



0508 TORNILLO CABEZA  
EXTRAPLANA 152



0509 TORNILLO CABEZA  
EXTRAPLANA AUTOTALADRANTE 153



0511 TORNILLO ROSCA  
CHAPA CON ARANDELA 154



0510 TORNILLO ROSCA CHAPA CON  
ARANDELA AUTOTALADRANTE 155



0512 DIN 7971 155



0504 DIN 7504-N PH 156



0517 DIN 7504-N STAR 157



0507 DIN 7504-P PH 158



0529 TORNILLO ROSCA CHAPA STAR  
CON ALETAS AUTOTALADRANTE 159



0530 TORNILLO ROSCA CHAPA PH  
CON ALETAS AUTOTALADRANTE 159



0518 DIN 7504-P STAR 160



0505 DIN 7504-K 161



0506 DIN 7504-K CON ARANDELA  
DE NEOPRENO 162



0531 DIN 7504-K PUNTA  
REDUCIDA 162



0532 DIN 7504-K PUNTA  
REDUCIDA + EPDM 163



0519 TORNILLO VIGA CON  
ARANDELA + EPDM 163



0544 TORNILLO BIMETAL  
+ EPDM BROCA Nº 3 164



0521 DIN 7504-K PANEL  
SANDWICH + EPDM BROCA Nº 3 164



0542 DIN 7504-K PANEL  
SANDWICH + EPDM BROCA Nº 5 164



0514 DIN 7504-K  
PANEL SANDWICH BROCA Nº 3 165



0543 DIN 7504-K  
PANEL SANDWICH BROCA Nº 5 165



0110 TORNILLO  
PARED STAR 166

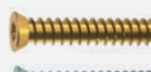

0540 TORNILLO FIJACIÓN DIRECTA  
A HORMIGÓN HEXAGONAL 167



0541 TORNILLO FIJACIÓN DIRECTA  
A HORMIGÓN AVELLANADO 167



0533 TORNILLO PARA HORMIGÓN C/  
HEX. HI-LO, PUNTA DIAMANTE 168



0534 TORNILLO PARA HORMIGÓN  
C/HEX. HI-LO, PUNTA  
DIAMANTE + EPDM 16 168



**20 TORNILLOS PVC**

2001 TORNILLO PVC CABEZA  
PLANA 170



2002 TORNILLO PVC CABEZA  
PLANA ROSCA HI-LO 170



2003 TORNILLO PVC CABEZA  
PLANA AUTOTALADRANTE 171



2004 TORNILLO PVC CABEZA  
PLANA ROSCA MÉTRICA  
AUTOTALADRANTE 171



**06 TORNILLOS DE PLÁSTICO**

0601 DIN 84 NYLON 174



0602 DIN 912 NYLON 174



0603 DIN 933-931 NYLON 175



0604 TORNILLO CABEZA  
REDONDA NYLON 175



0605 TORNILLO CABEZA  
ALOMADA CRUZ NYLON 176



0606 DIN 555 NYLON 177



0607 DIN 125 NYLON 177



0608 DIN 9021 NYLON 178



**07 TUERCAS**

0709 DIN 934 180



0710 DIN 934 C8 180



0740 DIN 934 C10 181



0711 DIN 936 181



0712 DIN 985 182



0744 DIN 985 C10 182



0717 TUERCA LAMPISTERÍA 182



0715 DIN 557 183



0716 DIN 6923 183



0736 DIN 929 183



0703 TUERCA EMBUTIR ALLEN  
HIERRO CON VALONA ESTRIADA 184



0731 TUERCA EMBUTIR ALLEN  
HIERRO CON VALONA REDUCIDA  
Y ESTRIADA 184



0746 TUERCA EMBUTIR CABEZA  
PLANA ALLEN ROSCA IZQUIERDA 184



0701 TUERCA EMBUTIR  
ALLEN HIERRO CON VALONA 185



0702 TUERCA EMBUTIR  
ALLEN HIERRO SIN VALONA 185



0743 TUERCA DE EMBUTIR CON  
RANURA Y SIN VALONA 186



0704 TUERCA ÉMBOLO DOBLE 186



0705 TUERCA ÉMBOLO HIERRO 186



0718 TUERCA 4 PÚAS 187



0734 TUERCA 4 PÚAS  
SIN ROSCAR 187



0762 TUERCA 4 PÚAS DENTADA 187



0763 TUERCA 4 PÚAS DENTADA  
REDUCIDA 188



0719 INSERTO ARPÓN 188



0720 INSERTO ARPÓN  
CON VALONA 188



0721 TUERCA ENJAULADA 189



0722 PALOMILLA 189



0706 TUERCA REMACHABLE  
GRAFILADA CON VALONA 190



0707 TUERCA REMACHABLE  
GRAFILADA SIN VALONA 190



0708 TUERCA REMACHABLE  
CUERPO HEXAGONAL 190



0724 DIN 1587 191



0723 TUERCA CIEGA LATÓN	191	
		
0713 DIN 986	192	
0714 DIN 980 V	192	
0726 TUERCA POMO LATÓN	193	
0730 INSERTO HEXAGONAL LATÓN	193	
0727 TUERCA EXPANSIBLE LATÓN	194	
		
0728 TUERCA EXPANSIBLE LATÓN CON BOLA PLÁSTICO	194	
0725 TUERCA EXPANSIBLE ZAMAK	195	
0729 TUERCA CAMA	195	
<b>08 ARANDELAS</b>		
0801 DIN 125 FORMA A	198	
0823 DIN 125 FORMA A HV 300	198	

0802 DIN 9021	199	
0803 ARANDELA ESTÁNDAR	199	
		
0804 DIN 127 FORMA B	200	
		
0805 DIN 7980	201	
		
0806 SUJECIÓN RÁPIDA CIRCULAR PARA EJES	201	
0810 ARANDELA LAMPARERA	202	
0807 DIN 6798 FORMA A	202	
		
0808 DIN 6798 FORMA J	203	
0809 DIN 6798 FORMA V	203	
0821 DIN 6797 FORMA A	204	
0811 ARANDELA ESPECIAL TORNILLO DIN 912	204	
0812 ARANDELA DENTADA DOBLE	205	
0820 DIN 137 FORMA B	205	

0813 DIN 6799	206	
0814 ANILLO DE SEGURIDAD DIN 471	206	
0815 ARANDELA NEOPRENO	207	
0816 ARANDELA CASCABEL	207	
0817 ARANDELA CAMA	207	
0818 DIN 125 LATÓN BISELADA	208	
0819 DIN 9021 LATÓN	208	
<b>09 TACOS, ANCLAJES Y BRIDAS DE NYLON</b>		
0931 TACO PLÁSTICO NYLON CAJITA	210	
0901 TACO PLÁSTICO NYLON GRANEL	210	
0932 TACO PLUS MAT CAJITA	210	
0913 TACO PLUS MAT GRANEL	211	
0936 TACO FACHADA CAJITA	211	
0935 TACO FACHADA GRANEL	211	

0902 TACO PLÁSTICO BLANCO GRANEL	212	
0914 TORNILLO TACO POZI	212	
0907 TACO PLÁSTICO UNIVERSAL CON ARANDELA	212	
0940 TACO + TORNILLO AVELLANADO STAR	213	
0941 TACO + TORNILLO HEXAGONAL	213	
0934 TACO SX PLUS CAJITA	213	
0903 TACO SX PLUS GRANEL	214	
0904 TACO SXL PLUS	214	
0905 TACO UNIVERSAL UX	214	
0906 TACO UNIVERSAL UX-R	215	
0948 TACO DÚO POWER	215	
0926 ANCLAJE METÁLICO	216	
0950 ANCLAJE METÁLICO LINEA AZUL	217	
2926 ANCLAJE METÁLICO ACERO INOXIDABLE	217	

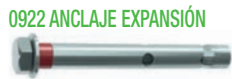

218

0924 ANCLAJE  
EXPANSIÓN ARGOLLA

218

0925 ANCLAJE  
EXPANSIÓN GANCHO

219

0952 ANCLAJE EXPANSIÓN  
GANCHO ESPIRAL

219

0927 ANCLAJE  
EXPANSIÓN HEMBRA

220

0951 ANCLAJE EXPANSIÓN  
HEMBRA MOLETEADO

220

0928 TACO RETACAR LATÓN



220

0908 TORNILLO PLADUR  
PASO FINO

221

0942 TORNILLO PLADUR  
PASO ANCHO

221

0944 TORNILLO PLADUR  
AUTOTALADRANTE

222

0915 TACO METÁLICO  
ARPÓN PLADUR

222

0912 TACO NYLON PLADUR



223

0929 TACO PLADUR  
ZAMAK AUTOTALADRANTE

223

0930 TACO PARAGUAS NYLON



223

0910 TACO METÁLICO  
AUTOPERFORANTE GKM

224

0911 TACO  
AUTOPERFORANTE GK

224

0916 TACO BASCULANTE  
ESPÁRRAGO

225

0917 TACO BASCULANTE  
GANCHO

225

0920 TACO BRIDA



225

0921 ABRAZADERA NYLON



227

**10 COMPLEMENTOS DE PLÁSTICO**

1001 DESLIZANTE



230

1002 DESLIZANTE TIRAS



230

1003 SOPORTE GUITARRA



230

1004 SOPORTE GRAPIÓN



231

1005 ZOLETA



231

1006 ZOLETA TIRAS



231

1007 SOPORTE LEJA



231

1008 TAPA PLÁSTICO  
EXCÉNTRICA

232

1033 TAPA PLÁSTICO  
PRESIÓN EXCÉNTRICA

232

1009 MEDIA LUNA PLÁSTICO



232

1010 SOPORTE PLÁSTICO TUBO



233

1011 SOPORTE ENGANCHE



233

1012 BOTE COLA



233

1013 POMO PLÁSTICO



234

1014 TUERCA EMBUTIR  
PLÁSTICO

234

1015 TUERCA EMBUTIR  
PLÁSTICO TIRAS

234

1016 SOPORTE  
PLÁSTICO CASQUILLO

235

1017 TAPÓN PLÁSTICO  
UNIÓN COCINA

235

1018 TAPÓN PLÁSTICO POZI

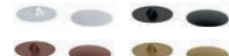

235

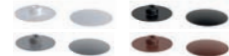
1019 TAPÓN  
PLÁSTICO ALLEN

235

1020 TAPÓN PLÁSTICO  
AGUJERO

236

1021 TAPÓN PLÁSTICO  
PORTAESTANTE

236

1022 TOPE ADHESIVO



236

1023 TAPATORNILLOS  
ADHESIVOS

237

1030 REGULADOR PATA



238

1031 TORNILLO REGULADOR



238

1032 CAPUCHÓN PLÁSTICO



238

**11 COMPLEMENTOS METÁLICOS**

1101 EXCÉNTRICA



240

1102 PERNO ROSCA  
MÉTRICA EXCÉNTRICA 241

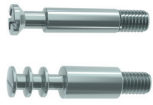

1103 PERNO ROSCA  
MADERA EXCÉNTRICA Ø 15 242



1106 TAPA EXCÉNTRICA 242



1107 GOLPETE NYLON 243



1108 SOPORTE SAFETI 243



1160 SOPORTE ESTANTE  
ESCUADRA CON VENTOSA 243



1109 SOPORTE ESTANTE  
METÁLICO 244



1110 SOPORTE VITRINA 244



1113 PIVOTE  
CENTRADOR MESA 245



1114 EMBELLECEDOR 245



1115 OVALILLO LATONADO 246



1117 GRAPA TRASERA REDONDA 246



1121 MEDIA LUNA 246



1122 MEDIA LUNA  
ROSCADA ZAMAK 247



1123 ESCUADRA  
CON PESTAÑA 247



1124 CARTABÓN 247



1125 ESCUADRA FORMA "L" 248



1126 PLACA 248



1127 CONJUNTO  
COLGADOR 249



1159 PLACA ENGANCHE  
SOFÁ 249



1128 ESCUADRA SOPORTE  
FORMA "U" 250



1129 MUELLE BALANCÍN 250



1130 CUADRADILLO LISO 251



1131 CUADRADILLO GRAFILADO 251



1134 VARILLA CUADRADA 251



1135 LLAVE ALLEN L 252



1138 LLAVE ALLEN STAR 8.8 252



1136 LLAVE ALLEN L  
ACERO TEMPLADO 253



1137 LLAVE ALLEN Z 253



1139 LLAVE FIJA 254



1140 BISAGRA LIBRO 254



1148 SOPORTE LATERAL  
BARRA ARMARIO 255



1149 SOPORTE CENTRAL  
BARRA ARMARIO 256



1150 BARRA ARMARIO 256



1151 JUEGO ENGANCHE  
ARMARIO 257



1153 ALCAYATA  
ROSCA MADERA 257



1154 CÁNCAMO CERRADO  
ROSCA MADERA 258



1155 CÁNCAMO ABIERTO  
ROSCA MADERA 259



1156 RODILLO  
TRASLACIÓN 259



1157 GRAPA PUENTE  
SENCILLA 260



1158 GRAPA PUENTE DOBLE 260



## 12 REMACHES Y PASADORES

1201 REMACHE TUBULAR  
ALUMINIO ESTÁNDAR 262



1202 REMACHE TUBULAR  
ALUMINIO ALA ANCHA 263



1204 REMACHE TUBULAR  
FLOR ALUMINIO 264



1205 REMACHE TUBULAR  
ACERO 265



1207 REMACHE TUBULAR  
TRÉBOL ALUMINIO 265



1208 REMACHE TUBULAR  
CABEZA AVELLANADA  
ALUMINIO 266



1209 REMACHE SEMITUBULAR 267



1210 PASADOR ELÁSTICO  
DIN 1481 268



1213 PASADOR-R 269



1212 PASADOR CENTRO EJE 269



1211 PASADOR ANILLA 270



### 13 PUNTAS

1301 PUNTA POZI TIPO A 272



1302 PUNTA PHILIPS TIPO A 272



1303 PUNTA ALLEN TIPO A 272



1304 PUNTA STAR TIPO A 273



1305 PUNTA STAR  
INVOLABLE TIPO A 273



1306 PUNTA POZI TIPO B 273



1307 PUNTA PHILIPS TIPO B 274



1308 PUNTA STAR TIPO B 274



1309 BIT ROSCADOR POZI 274



1310 BIT ROSCADOR STAR 275



1311 ÚTIL ALLEN PARA  
TUERCA EMBUTIR 275



1312 ACOPLAMIENTO  
PARA ESPÁRRAGO 275



1313 SOPORTE UNIVERSAL  
IMANTADO 276



1314 SOPORTE UNIVERSAL  
CAMBIO RÁPIDO 276



1315 ADAPTADOR PARA  
LLAVE MAGNÉTICO 276



### 15 CADENA, ACCESORIOS PARA CABLES Y ELEMENTOS ELEVACIÓN

1523 CADENA COMERCIAL  
CINCADA 278



1524 CADENA ALTA  
RESISTENCIA GRADO 80 278



3525 DIN 5685 AISI 316  
INOXIDABLE 279



1530 REGULADOR CABLE 279



1501 SUJETACABLES  
DIN 741 280



1502 SUJETACABLES  
FORMA ESPAÑOLA 280



1503 SUJETACABLES  
PLANO SIMPLE 281



1504 SUJETACABLES  
PLANO DOBLE 281

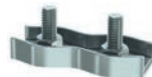

1505 ESE GALVANIZADA 282



1506 MOSQUETÓN BOMBERO 282



1507 MOSQUETÓN  
BOMBERO CON SEGURO 283



1508 MALLA RÁPIDA 283



1510 GIRATORIO-QUITAVUELTAS 283



1509 TENSOR JARDINERA 284



1511 GRILLETE RECTO  
GALVANIZADO 284



1512 TENSOR  
GANCHO-ANILLA DIN 1480 285



1513 ANILLA ELEVACIÓN  
MACHO DIN 580 285



1514 ANILLA ELEVACIÓN  
HEMBRA DIN 582 286



1515 ANILLA TENSOR 286



1516 TRINCAJES 287



1517 GUARDACABOS 287



1518 GANCHO ELEVACIÓN  
CON SEGURO 288



1519 GANCHO  
AUTOCIERRE GRADO 80 288







**TORNILLOS  
ROSCA MADERA**

**01**

0101 DIN 7505-A

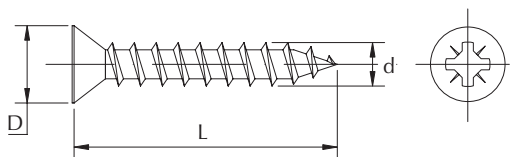

d mm	2,5	3	3,5	4	4,5	5	6
D mm	5	6	7	8	9	10	12

- Tornillo para la madera con cabeza avellanada y huella pozidrive.
- Es el tornillo adecuado tanto para unir tableros o listones de carpintería entre si como para atornillar piezas y herrajes de metal a la madera.
- Con tratamiento térmico que aporta mayor dureza.

CÓDIGO	(d)	L	+	ENVASE
01010250010B	2,5	10	PZ1	1.000
01010250012B	2,5	12	PZ1	1.000
01010250013B	2,5	13	PZ1	1.000
01010250015B	2,5	15	PZ1	1.000
01010250016B	2,5	16	PZ1	1.000
01010250017B	2,5	17	PZ1	1.000
01010250020B	2,5	20	PZ1	1.000
01010250025B	2,5	25	PZ1	1.000
01010250030B	2,5	30	PZ1	1.000
01010300010B	3	10	PZ1	1.000
01010300012B	3	12	PZ1	1.000
01010300013B	3	13	PZ1	1.000
01010300015B	3	15	PZ1	1.000
01010300016B	3	16	PZ1	1.000
01010300017B	3	17	PZ1	1.000
01010300020B	3	20	PZ1	1.000
01010300025B	3	25	PZ1	1.000
01010300030B	3	30	PZ1	1.000
01010300035B	3	35	PZ1	1.000
01010300040B	3	40	PZ1	1.000
01010300045B	3	45	PZ1	1.000
01010350010B	3,5	10	PZ2	1.000
01010350012B	3,5	12	PZ2	1.000
01010350013B	3,5	13	PZ2	1.000
01010350015B	3,5	15	PZ2	1.000
01010350016B	3,5	16	PZ2	1.000
01010350017B	3,5	17	PZ2	1.000
01010350020B	3,5	20	PZ2	1.000
01010350025B	3,5	25	PZ2	1.000
01010350030B	3,5	30	PZ2	1.000
01010350035B	3,5	35	PZ2	1.000
01010350040B	3,5	40	PZ2	1.000
01010350045B	3,5	45	PZ2	1.000
01010350050B	3,5	50	PZ2	500
01010350055B	3,5	55	PZ2	500
01010350060B	3,5	60	PZ2	500
01010400015B	4	15	PZ2	1.000
01010400016B	4	16	PZ2	1.000
01010400017B	4	17	PZ2	1.000
01010400020B	4	20	PZ2	1.000
01010400025B	4	25	PZ2	1.000
01010400030B	4	30	PZ2	1.000
01010400035B	4	35	PZ2	1.000
01010400040B	4	40	PZ2	1.000
01010400045B	4	45	PZ2	500
01010400050B	4	50	PZ2	500
01010400055B	4	55	PZ2	500
01010400060B	4	60	PZ2	500

CÓDIGO	(d)	L	+	ENVASE
01010400070B	4	70	PZ2	500
01010450015B	4,5	15	PZ2	1.000
01010450016B	4,5	16	PZ2	1.000
01010450017B	4,5	17	PZ2	1.000
01010450020B	4,5	20	PZ2	1.000
01010450025B	4,5	25	PZ2	1.000
01010450030B	4,5	30	PZ2	1.000
01010450035B	4,5	35	PZ2	1.000
01010450040B	4,5	40	PZ2	1.000
01010450045B	4,5	45	PZ2	500
01010450050B	4,5	50	PZ2	500
01010450055B	4,5	55	PZ2	500
01010450060B	4,5	60	PZ2	500
01010450065B	4,5	65	PZ2	500
01010450070B	4,5	70	PZ2	500
01010450080B	4,5	80	PZ2	200
01010450090B	4,5	90	PZ2	200
01010450100B	4,5	100	PZ2	100
01010500020B	5	20	PZ2	1.000
01010500025B	5	25	PZ2	1.000
01010500030B	5	30	PZ2	1.000
01010500035B	5	35	PZ2	1.000
01010500040B	5	40	PZ2	500
01010500045B	5	45	PZ2	500
01010500050B	5	50	PZ2	500
01010500055B	5	55	PZ2	500
01010500060B	5	60	PZ2	500
01010500070B	5	70	PZ2	200
01010500080B	5	80	PZ2	200
01010500090B	5	90	PZ2	200
01010500100B	5	100	PZ2	200
01010600030B	6	30	PZ3	500
01010600035B	6	35	PZ3	500
01010600040B	6	40	PZ3	200
01010600045B	6	45	PZ3	200
01010600050B	6	50	PZ3	200
01010600060B	6	60	PZ3	200
01010600070B	6	70	PZ3	200
01010600080B	6	80	PZ3	100
01010600090B	6	90	PZ3	100
01010600100B	6	100	PZ3	100
01010600110B	6	110	PZ3	100
01010600120B	6	120	PZ3	100
01010600140B	6	140	PZ3	100
01010600160B	6	160	PZ3	100
01010600180B	6	180	PZ3	100
01010600200B	6	200	PZ3	100

Consultar disponibilidad en otros recubrimientos.

Medidas en mm.



Puntas de atornillar disponibles en página 272.

## 0101 DIN 7505-A

d mm	2,5	3	3,5	4	4,5	5	6
D mm	5	6	7	8	9	10	12

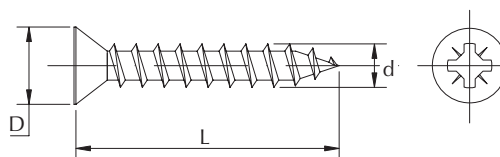

- Tornillo para la madera con cabeza avellanada y huella pozidrive.
- Es el tornillo adecuado tanto para unir tableros o listones de carpintería entre si como para atornillar piezas y herrajes de metal a la madera.
- Con tratamiento térmico que aporta mayor dureza.



CÓDIGO	(d)	L	+	ENVASE
01010250010Z	2,5	10	PZ1	1.000
01010250012Z	2,5	12	PZ1	1.000
01010250013Z	2,5	13	PZ1	1.000
01010250015Z	2,5	15	PZ1	1.000
01010250016Z	2,5	16	PZ1	1.000
01010250017Z	2,5	17	PZ1	1.000
01010250020Z	2,5	20	PZ1	1.000
01010250025Z	2,5	25	PZ1	1.000
01010250030Z	2,5	30	PZ1	1.000
01010300010Z	3	10	PZ1	1.000
01010300012Z	3	12	PZ1	1.000
01010300013Z	3	13	PZ1	1.000
01010300015Z	3	15	PZ1	1.000
01010300016Z	3	16	PZ1	1.000
01010300017Z	3	17	PZ1	1.000
01010300020Z	3	20	PZ1	1.000
01010300025Z	3	25	PZ1	1.000
01010300030Z	3	30	PZ1	1.000
01010300035Z	3	35	PZ1	1.000
01010300040Z	3	40	PZ1	1.000
01010300045Z	3	45	PZ1	1.000
01010350010Z	3,5	10	PZ2	1.000
01010350012Z	3,5	12	PZ2	1.000
01010350013Z	3,5	13	PZ2	1.000
01010350015Z	3,5	15	PZ2	1.000
01010350016Z	3,5	16	PZ2	1.000
01010350017Z	3,5	17	PZ2	1.000
01010350020Z	3,5	20	PZ2	1.000
01010350025Z	3,5	25	PZ2	1.000
01010350030Z	3,5	30	PZ2	1.000
01010350035Z	3,5	35	PZ2	1.000
01010350040Z	3,5	40	PZ2	1.000
01010350045Z	3,5	45	PZ2	1.000
01010350050Z	3,5	50	PZ2	500
01010350055Z	3,5	55	PZ2	500
01010350060Z	3,5	60	PZ2	500
01010400015Z	4	15	PZ2	1.000
01010400016Z	4	16	PZ2	1.000
01010400017Z	4	17	PZ2	1.000
01010400020Z	4	20	PZ2	1.000
01010400025Z	4	25	PZ2	1.000
01010400030Z	4	30	PZ2	1.000
01010400035Z	4	35	PZ2	1.000
01010400040Z	4	40	PZ2	1.000
01010400045Z	4	45	PZ2	500
01010400050Z	4	50	PZ2	500
01010400055Z	4	55	PZ2	500
01010400060Z	4	60	PZ2	500

CÓDIGO	(d)	L	+	ENVASE
01010400070Z	4	70	PZ2	500
01010450015Z	4,5	15	PZ2	1.000
01010450016Z	4,5	16	PZ2	1.000
01010450017Z	4,5	17	PZ2	1.000
01010450020Z	4,5	20	PZ2	1.000
01010450025Z	4,5	25	PZ2	1.000
01010450030Z	4,5	30	PZ2	1.000
01010450035Z	4,5	35	PZ2	1.000
01010450040Z	4,5	40	PZ2	1.000
01010450045Z	4,5	45	PZ2	500
01010450050Z	4,5	50	PZ2	500
01010450055Z	4,5	55	PZ2	500
01010450060Z	4,5	60	PZ2	500
01010450065Z	4,5	65	PZ2	500
01010450070Z	4,5	70	PZ2	500
01010450080Z	4,5	80	PZ2	200
01010450090Z	4,5	90	PZ2	200
01010450100Z	4,5	100	PZ2	100
01010500020Z	5	20	PZ2	1.000
01010500025Z	5	25	PZ2	1.000
01010500030Z	5	30	PZ2	1.000
01010500035Z	5	35	PZ2	1.000
01010500040Z	5	40	PZ2	500
01010500045Z	5	45	PZ2	500
01010500050Z	5	50	PZ2	500
01010500055Z	5	55	PZ2	500
01010500060Z	5	60	PZ2	500
01010500070Z	5	70	PZ2	200
01010500080Z	5	80	PZ2	200
01010500090Z	5	90	PZ2	200
01010500100Z	5	100	PZ2	200
01010600030Z	6	30	PZ3	500
01010600035Z	6	35	PZ3	500
01010600040Z	6	40	PZ3	200
01010600045Z	6	45	PZ3	200
01010600050Z	6	50	PZ3	200
01010600060Z	6	60	PZ3	200
01010600070Z	6	70	PZ3	200
01010600080Z	6	80	PZ3	100
01010600090Z	6	90	PZ3	100
01010600100Z	6	100	PZ3	100
01010600110Z	6	110	PZ3	100
01010600120Z	6	120	PZ3	100
01010600140Z	6	140	PZ3	100
01010600160Z	6	160	PZ3	100
01010600180Z	6	180	PZ3	100
01010600200Z	6	200	PZ3	100

Consultar disponibilidad en otros recubrimientos.

0103 DIN 7505-B

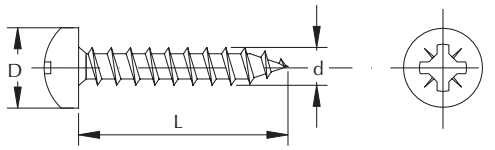

d mm	2	2,5	3	3,5	4	4,5	5
D mm	4	5	6	7	8	9	9,5

- Tornillo para la madera con cabeza alomada y huella pozidrive.
- Es el tornillo adecuado tanto para atornillar piezas y herrajes de metal a la madera.
- La superficie plana del contacto asegura un apriete eficaz.
- Con tratamiento térmico que aporta mayor dureza.

CÓDIGO	(d)	L	+	ENVASE
01030250010B	2,5	10	PZ1	1.000
01030250012B	2,5	12	PZ1	1.000
01030250013B	2,5	13	PZ1	1.000
01030250015B	2,5	15	PZ1	1.000
01030250017B	2,5	17	PZ1	1.000
01030250020B	2,5	20	PZ1	1.000
01030250025B	2,5	25	PZ1	1.000
01030250030B	2,5	30	PZ1	1.000
01030300010B	3	10	PZ1	1.000
01030300013B	3	13	PZ1	1.000
01030300015B	3	15	PZ1	1.000
01030300017B	3	17	PZ1	1.000
01030300020B	3	20	PZ1	1.000
01030300025B	3	25	PZ1	1.000
01030350010B	3,5	10	PZ2	1.000
01030350013B	3,5	13	PZ2	1.000
01030350015B	3,5	15	PZ2	1.000
01030350017B	3,5	17	PZ2	1.000
01030350020B	3,5	20	PZ2	1.000
01030350025B	3,5	25	PZ2	1.000
01030350030B	3,5	30	PZ2	1.000
01030350035B	3,5	35	PZ2	1.000
01030350040B	3,5	40	PZ2	1.000
01030400013B	4	13	PZ2	1.000
01030400015B	4	15	PZ2	1.000
01030400017B	4	17	PZ2	1.000
01030400020B	4	20	PZ2	1.000

CÓDIGO	(d)	L	+	ENVASE
01030400025B	4	25	PZ2	1.000
01030400030B	4	30	PZ2	1.000
01030400035B	4	35	PZ2	1.000
01030400040B	4	40	PZ2	1.000
01030400045B	4	45	PZ2	1.000
01030400050B	4	50	PZ2	1.000
01030450015B	4,5	15	PZ2	1.000
01030450017B	4,5	17	PZ2	1.000
01030450020B	4,5	20	PZ2	1.000
01030450025B	4,5	25	PZ2	1.000
01030450030B	4,5	30	PZ2	1.000
01030450035B	4,5	35	PZ2	1.000
01030450040B	4,5	40	PZ2	1.000
01030450045B	4,5	45	PZ2	500
01030450050B	4,5	50	PZ2	500
01030450060B	4,5	60	PZ2	500
01030500013B	5	13	PZ2	1.000
01030500015B	5	15	PZ2	1.000
01030500016B	5	16	PZ2	1.000
01030500020B	5	20	PZ2	1.000
01030500025B	5	25	PZ2	1.000
01030500030B	5	30	PZ2	1.000
01030500035B	5	35	PZ2	1.000
01030500040B	5	40	PZ2	500
01030500045B	5	45	PZ2	500
01030500050B	5	50	PZ2	500
01030500060B	5	60	PZ2	500

Consultar disponibilidad en otros recubrimientos.



## 0103 DIN 7505-B

d mm	2	2,5	3	3,5	4	4,5	5
D mm	4	5	6	7	8	9	9,5

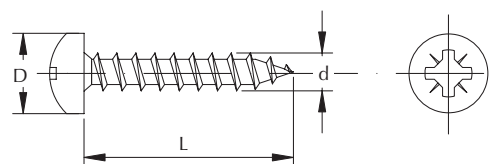

- Tornillo para la madera con cabeza alomada y huella pozidrive.
- Es el tornillo adecuado tanto para atornillar piezas y herrajes de metal a la madera.
- La superficie plana del contacto asegura un apriete eficaz.
- Con tratamiento térmico que aporta mayor dureza.



CÓDIGO	(d)	L	+	ENVASE
01030200016Z	2	16	PZ1	1.000
01030250010Z	2,5	10	PZ1	1.000
01030250013Z	2,5	13	PZ1	1.000
01030250015Z	2,5	15	PZ1	1.000
01030250017Z	2,5	17	PZ1	1.000
01030250020Z	2,5	20	PZ1	1.000
01030250025Z	2,5	25	PZ1	1.000
01030250030Z	2,5	30	PZ1	1.000
01030300010Z	3	10	PZ1	1.000
01030300013Z	3	13	PZ1	1.000
01030300015Z	3	15	PZ1	1.000
01030300017Z	3	17	PZ1	1.000
01030300020Z	3	20	PZ1	1.000
01030300025Z	3	25	PZ1	1.000
01030350010Z	3,5	10	PZ2	1.000
01030350013Z	3,5	13	PZ2	1.000
01030350015Z	3,5	15	PZ2	1.000
01030350017Z	3,5	17	PZ2	1.000
01030350020Z	3,5	20	PZ2	1.000
01030350025Z	3,5	25	PZ2	1.000
01030350030Z	3,5	30	PZ2	1.000
01030350035Z	3,5	35	PZ2	1.000
01030350040Z	3,5	40	PZ2	1.000
01030350045Z	3,5	45	PZ2	1.000
01030400013Z	4	13	PZ2	1.000
01030400015Z	4	15	PZ2	1.000
01030400017Z	4	17	PZ2	1.000
01030400020Z	4	20	PZ2	1.000

CÓDIGO	(d)	L	+	ENVASE
01030400025Z	4	25	PZ2	1.000
01030400030Z	4	30	PZ2	1.000
01030400035Z	4	35	PZ2	1.000
01030400040Z	4	40	PZ2	1.000
01030400045Z	4	45	PZ2	1.000
01030400050Z	4	50	PZ2	1.000
01030450015Z	4,5	15	PZ2	1.000
01030450017Z	4,5	17	PZ2	1.000
01030450018Z	4,5	18	PZ2	1.000
01030450020Z	4,5	20	PZ2	1.000
01030450025Z	4,5	25	PZ2	1.000
01030450030Z	4,5	30	PZ2	1.000
01030450035Z	4,5	35	PZ2	1.000
01030450040Z	4,5	40	PZ2	1.000
01030450045Z	4,5	45	PZ2	500
01030450050Z	4,5	50	PZ2	500
01030450060Z	4,5	60	PZ2	500
01030500013Z	5	13	PZ2	1.000
01030500015Z	5	15	PZ2	1.000
01030500020Z	5	20	PZ2	1.000
01030500025Z	5	25	PZ2	1.000
01030500030Z	5	30	PZ2	1.000
01030500035Z	5	35	PZ2	1.000
01030500040Z	5	40	PZ2	500
01030500045Z	5	45	PZ2	500
01030500050Z	5	50	PZ2	500
01030500060Z	5	60	PZ2	500



CÓDIGO	(d)	L	+	ENVASE
01030200010L	2	10	PZ1	1.000
01030200012L	2	12	PZ1	1.000
01030200013L	2	13	PZ1	1.000

CÓDIGO	(d)	L	+	ENVASE
01030200015L	2	15	PZ1	1.000
01030200016L	2	16	PZ1	1.000

Consultar disponibilidad en otros recubrimientos.

# KaT<sup>®</sup>

El elegido por los profesionales de la madera.

KaT<sup>®</sup>  
POZI



KaT<sup>®</sup>  
NEX  
POZI



KaT<sup>®</sup>  
STAR



KaT<sup>®</sup>  
STAR PLUS  
ANTICORROSIÓN



KaT<sup>®</sup>  
STAR  
EMBELLECEDOR



KaT<sup>®</sup>  
STAR  
ARANDELA



KaT<sup>®</sup>  
STAR DM



0104 KAT POZI 

d mm	2,5	3	3,5	4	4,5	5	6
D mm	5	6	7	8	9	10	12

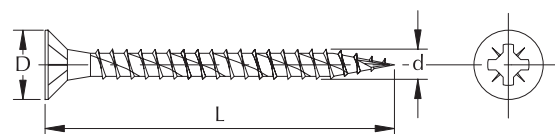

- Tornillo para la madera de gama alta.
- No necesita pretaladros en mayoría de maderas.
- Punta fresada y sistema multicorte en espiral patentado: proporciona rápida inserción y mayor extracción de viruta.
- Cabeza reforzada para reducir torsión.
- Estrías adherentes bajo cabeza reducen riesgos de rotura en la madera.
- Con tratamiento térmico que aporta mayor dureza.



CÓDIGO	(d)	L	+	ENVASE
01040250010B	2,5	10	PZ1	1.000
01040250012B	2,5	12	PZ1	1.000
01040250013B	2,5	13	PZ1	1.000
01040250015B	2,5	15	PZ1	1.000
01040250016B	2,5	16	PZ1	1.000
01040250017B	2,5	17	PZ1	1.000
01040250020B	2,5	20	PZ1	1.000
01040250025B	2,5	25	PZ1	1.000
01040300010B	3	10	PZ1	1.000
01040300012B	3	12	PZ1	1.000
01040300013B	3	13	PZ1	1.000
01040300015B	3	15	PZ1	1.000
01040300016B	3	16	PZ1	1.000
01040300017B	3	17	PZ1	1.000
01040300020B	3	20	PZ1	1.000
01040300025B	3	25	PZ1	1.000
01040300030B	3	30	PZ1	1.000
01040300035B	3	35	PZ1	1.000
01040300040B	3	40	PZ1	1.000
01040350010B	3,5	10	PZ2	1.000
01040350012B	3,5	12	PZ2	1.000
01040350013B	3,5	13	PZ2	1.000
01040350015B	3,5	15	PZ2	1.000
01040350016B	3,5	16	PZ2	1.000
01040350017B	3,5	17	PZ2	1.000
01040350020B	3,5	20	PZ2	1.000
01040350025B	3,5	25	PZ2	1.000
01040350030B	3,5	30	PZ2	1.000
01040350035B	3,5	35	PZ2	1.000
01040350040B	3,5	40	PZ2	1.000
01040350045B	3,5	45	PZ2	1.000
01040350050B	3,5	50	PZ2	500
01040350060B	3,5	60	PZ2	500
01040400013B	4	13	PZ2	1.000
01040400015B	4	15	PZ2	1.000
01040400016B	4	16	PZ2	1.000
01040400017B	4	17	PZ2	1.000
01040400020B	4	20	PZ2	1.000
01040400025B	4	25	PZ2	1.000
01040400030B	4	30	PZ2	1.000
01040400035B	4	35	PZ2	1.000
01040400040B	4	40	PZ2	1.000
01040400045B	4	45	PZ2	1.000
01040400050B	4	50	PZ2	500

CÓDIGO	(d)	L	+	ENVASE
01040400055B	4	55	PZ2	500
01040400060B	4	60	PZ2	500
01040400070B	4	70	PZ2	500
01040450015B	4,5	15	PZ2	1.000
01040450016B	4,5	16	PZ2	1.000
01040450020B	4,5	20	PZ2	1.000
01040450025B	4,5	25	PZ2	1.000
01040450030B	4,5	30	PZ2	1.000
01040450035B	4,5	35	PZ2	1.000
01040450040B	4,5	40	PZ2	1.000
01040450045B	4,5	45	PZ2	1.000
01040450050B	4,5	50	PZ2	500
01040450055B	4,5	55	PZ2	500
01040450060B	4,5	60	PZ2	500
01040450065B	4,5	65	PZ2	500
01040450070B	4,5	70	PZ2	500
01040450080B	4,5	80	PZ2	200
01040500020B	5	20	PZ2	1.000
01040500025B	5	25	PZ2	1.000
01040500030B	5	30	PZ2	500
01040500035B	5	35	PZ2	500
01040500040B	5	40	PZ2	500
01040500045B	5	45	PZ2	500
01040500050B	5	50	PZ2	500
01040500060B	5	60	PZ2	500
01040500070B	5	70	PZ2	200
01040500080B	5	80	PZ2	200
01040500090B	5	90	PZ2	200
01040500100B	5	100	PZ2	200
01040600030B	6	30	PZ3	500
01040600035B	6	35	PZ3	500
01040600040B	6	40	PZ3	500
01040600045B	6	45	PZ3	500
01040600050B	6	50	PZ3	200
01040600060B	6	60	PZ3	200
01040600070B	6	70	PZ3	200
01040600080B	6	80	PZ3	200
01040600090B	6	90	PZ3	200
01040600100B	6	100	PZ3	100
01040600120B	6	120	PZ3	100
01040600140B	6	140	PZ3	100
01040600160B	6	160	PZ3	100
01040600180B	6	180	PZ3	100
01040600200B	6	200	PZ3	100

0104 KAT POZI 

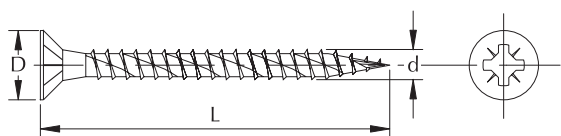

d mm	2,5	3	3,5	4	4,5	5	6
D mm	5	6	7	8	9	10	12



- Tornillo para la madera de gama alta.
- No necesita pretaladros en mayoría de maderas.
- Punta fresada y sistema multicorte en espiral patentado: proporciona rápida inserción y mayor extracción de viruta.
- Cabeza reforzada para reducir torsión.
- Estrías adherentes bajo cabeza reducen riesgos de rotura en la madera.
- Con tratamiento térmico que aporta mayor dureza.

CÓDIGO	(d)	L	+	ENVASE
01040250010Z	2,5	10	PZ1	1.000
01040250012Z	2,5	12	PZ1	1.000
01040250013Z	2,5	13	PZ1	1.000
01040250015Z	2,5	15	PZ1	1.000
01040250016Z	2,5	16	PZ1	1.000
01040250017Z	2,5	17	PZ1	1.000
01040250020Z	2,5	20	PZ1	1.000
01040250025Z	2,5	25	PZ1	1.000
01040300010Z	3	10	PZ1	1.000
01040300012Z	3	12	PZ1	1.000
01040300013Z	3	13	PZ1	1.000
01040300015Z	3	15	PZ1	1.000
01040300016Z	3	16	PZ1	1.000
01040300017Z	3	17	PZ1	1.000
01040300020Z	3	20	PZ1	1.000
01040300025Z	3	25	PZ1	1.000
01040300030Z	3	30	PZ1	1.000
01040300035Z	3	35	PZ1	1.000
01040300040Z	3	40	PZ1	1.000
01040350010Z	3,5	10	PZ2	1.000
01040350012Z	3,5	12	PZ2	1.000
01040350013Z	3,5	13	PZ2	1.000
01040350015Z	3,5	15	PZ2	1.000
01040350016Z	3,5	16	PZ2	1.000
01040350017Z	3,5	17	PZ2	1.000
01040350020Z	3,5	20	PZ2	1.000
01040350025Z	3,5	25	PZ2	1.000
01040350030Z	3,5	30	PZ2	1.000
01040350035Z	3,5	35	PZ2	1.000
01040350040Z	3,5	40	PZ2	1.000
01040350045Z	3,5	45	PZ2	1.000
01040350050Z	3,5	50	PZ2	500
01040350060Z	3,5	60	PZ2	500
01040400013Z	4	13	PZ2	1.000
01040400015Z	4	15	PZ2	1.000
01040400016Z	4	16	PZ2	1.000
01040400017Z	4	17	PZ2	1.000
01040400020Z	4	20	PZ2	1.000
01040400025Z	4	25	PZ2	1.000
01040400030Z	4	30	PZ2	1.000
01040400035Z	4	35	PZ2	1.000
01040400040Z	4	40	PZ2	1.000
01040400045Z	4	45	PZ2	1.000
01040400050Z	4	50	PZ2	500

CÓDIGO	(d)	L	+	ENVASE
01040400055Z	4	55	PZ2	500
01040400060Z	4	60	PZ2	500
01040400070Z	4	70	PZ2	500
01040450015Z	4,5	15	PZ2	1.000
01040450016Z	4,5	16	PZ2	1.000
01040450020Z	4,5	20	PZ2	1.000
01040450025Z	4,5	25	PZ2	1.000
01040450030Z	4,5	30	PZ2	1.000
01040450035Z	4,5	35	PZ2	1.000
01040450040Z	4,5	40	PZ2	1.000
01040450045Z	4,5	45	PZ2	1.000
01040450050Z	4,5	50	PZ2	500
01040450055Z	4,5	55	PZ2	500
01040450060Z	4,5	60	PZ2	500
01040450065Z	4,5	65	PZ2	500
01040450070Z	4,5	70	PZ2	200
01040450080Z	4,5	80	PZ2	200
01040500020Z	5	20	PZ2	1.000
01040500025Z	5	25	PZ2	1.000
01040500030Z	5	30	PZ2	500
01040500035Z	5	35	PZ2	500
01040500040Z	5	40	PZ2	500
01040500045Z	5	45	PZ2	500
01040500050Z	5	50	PZ2	500
01040500060Z	5	60	PZ2	500
01040500070Z	5	70	PZ2	200
01040500080Z	5	80	PZ2	200
01040500090Z	5	90	PZ2	200
01040500100Z	5	100	PZ2	200
01040600030Z	6	30	PZ3	500
01040600035Z	6	35	PZ3	500
01040600040Z	6	40	PZ3	500
01040600045Z	6	45	PZ3	500
01040600050Z	6	50	PZ3	200
01040600060Z	6	60	PZ3	200
01040600070Z	6	70	PZ3	200
01040600080Z	6	80	PZ3	200
01040600090Z	6	90	PZ3	200
01040600100Z	6	100	PZ3	100
01040600120Z	6	120	PZ3	100
01040600140Z	6	140	PZ3	100
01040600160Z	6	160	PZ3	100
01040600180Z	6	180	PZ3	100
01040600200Z	6	200	PZ3	100

Medidas en mm.

 Puntas de atornillar disponibles en página 272.



0105 KAT POZI PICKING 

d mm	3	3,5	4	4,5
D mm	6	7	8	9

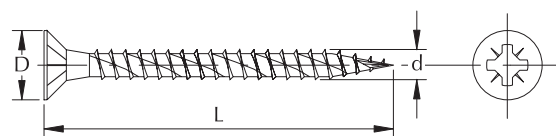

- Tornillo para la madera de gama alta.
- No necesita pretaladros en mayoría de maderas.
- Punta fresada y sistema multicorte en espiral patentado: proporciona rápida inserción y mayor extracción de viruta.
- Cabeza reforzada para reducir torsión.
- Estrías adherentes bajo cabeza reducen riesgos de rotura en la madera.
- Con tratamiento térmico que aporta mayor dureza.



CÓDIGO	(d)	L	+	ENVASE
01050300010B	3	10	PZ1	200
01050300012B	3	12	PZ1	200
01050300016B	3	16	PZ1	200
01050300020B	3	20	PZ1	200
01050300025B	3	25	PZ1	200
01050300030B	3	30	PZ1	200
01050300035B	3	35	PZ1	100
01050300040B	3	40	PZ1	100
01050350010B	3,5	10	PZ2	200
01050350016B	3,5	16	PZ2	200
01050350020B	3,5	20	PZ2	200
01050350025B	3,5	25	PZ2	200
01050350030B	3,5	30	PZ2	200
01050350035B	3,5	35	PZ2	100
01050350040B	3,5	40	PZ2	100
01050350045B	3,5	45	PZ2	100

CÓDIGO	(d)	L	+	ENVASE
01050350050B	3,5	50	PZ2	100
01050400016B	4	16	PZ2	200
01050400020B	4	20	PZ2	200
01050400025B	4	25	PZ2	200
01050400030B	4	30	PZ2	200
01050400035B	4	35	PZ2	100
01050400040B	4	40	PZ2	100
01050400045B	4	45	PZ2	100
01050400050B	4	50	PZ2	100
01050450016B	4,5	16	PZ2	200
01050450020B	4,5	20	PZ2	200
01050450025B	4,5	25	PZ2	200
01050450030B	4,5	30	PZ2	100
01050450035B	4,5	35	PZ2	100
01050450040B	4,5	40	PZ2	100

- Tornillo para la madera de gama alta.
- No necesita pretaladros en mayoría de maderas.
- Punta fresada y sistema multicorte en espiral patentado: proporciona rápida inserción y mayor extracción de viruta.
- Cabeza reforzada para reducir torsión.
- Estrías adherentes bajo cabeza reducen riesgos de rotura en la madera.
- Con tratamiento térmico que aporta mayor dureza.

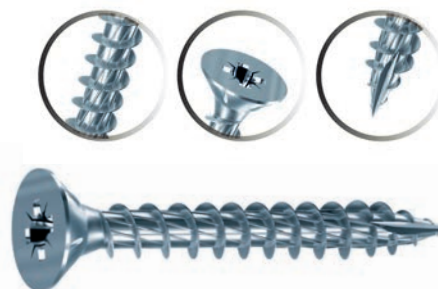

CÓDIGO	(d)	L	+	ENVASE
01050300010Z	3	10	PZ1	200
01050300016Z	3	16	PZ1	200
01050300020Z	3	20	PZ1	200
01050300025Z	3	25	PZ1	200
01050300030Z	3	30	PZ1	200
01050300035Z	3	35	PZ1	100
01050300040Z	3	40	PZ1	100
01050350012Z	3,5	12	PZ2	200
01050350016Z	3,5	16	PZ2	200
01050350020Z	3,5	20	PZ2	200
01050350025Z	3,5	25	PZ2	200
01050350030Z	3,5	30	PZ2	200
01050350035Z	3,5	35	PZ2	100
01050350040Z	3,5	40	PZ2	100
01050350045Z	3,5	45	PZ2	100

CÓDIGO	(d)	L	+	ENVASE
01050350050Z	3,5	50	PZ2	100
01050400016Z	4	16	PZ2	200
01050400020Z	4	20	PZ2	200
01050400025Z	4	25	PZ2	200
01050400030Z	4	30	PZ2	200
01050400035Z	4	35	PZ2	100
01050400040Z	4	40	PZ2	100
01050400045Z	4	45	PZ2	100
01050400050Z	4	50	PZ2	100
01050450016Z	4,5	16	PZ2	200
01050450020Z	4,5	20	PZ2	200
01050450025Z	4,5	25	PZ2	200
01050450030Z	4,5	30	PZ2	100
01050450035Z	4,5	35	PZ2	100
01050450040Z	4,5	40	PZ2	100

**KaT**<sup>®</sup>  
NEX

Espiral NEX para la mejor  
unión entre módulos.

Con estrías adherentes bajo la  
cabeza para reducir el riesgo  
de rotura de la madera.

Punta taladrante con  
cuchilla, evita pretaladros en  
la mayoría de maderas.

Sistema multicorte en espiral patentado que  
proporciona rápida inserción y mayor extracción  
de viruta.

**KaT**<sup>®</sup>

*El elegido por los profesionales de la madera*

0107 KAT STAR 

d mm	3	3,5	4	4,5	5	6	8	10
D mm	6	7	8	9	10	12	14	17

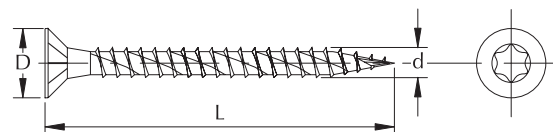

- Tornillo para la madera de gama alta.
- Huella hexalobular que mejora el agarre de la punta de atornillar.
- No necesita pretaladros en la mayoría de maderas.
- Punta fresada y sistema multicorte en espiral patentado: proporciona rápida inserción y mayor extracción de viruta.
- Cabeza reforzada para reducir torsión.
- Estrías adherentes bajo cabeza reducen riesgos de rotura en la madera.
- Con tratamiento térmico que aporta mayor dureza.



CÓDIGO	(d)	L	⊗	ENWASE
01070300012B	3	12	T10	1.000
01070300013B	3	13	T10	1.000
01070300015B	3	15	T10	1.000
01070300017B	3	17	T10	1.000
01070300020B	3	20	T10	1.000
01070300025B	3	25	T10	1.000
01070300030B	3	30	T10	1.000
01070300035B	3	35	T10	1.000
01070300040B	3	40	T10	1.000
01070350013B	3,5	13	T15	1.000
01070350015B	3,5	15	T15	1.000
01070350016B	3,5	16	T15	1.000
01070350017B	3,5	17	T15	1.000
01070350020B	3,5	20	T15	1.000
01070350025B	3,5	25	T15	1.000
01070350030B	3,5	30	T15	1.000
01070350035B	3,5	35	T15	1.000
01070350040B	3,5	40	T15	1.000
01070350045B	3,5	45	T15	1.000
01070350050B	3,5	50	T15	500
01070400012B	4	12	T20	1.000
01070400015B	4	15	T20	1.000
01070400016B	4	16	T20	1.000
01070400017B	4	17	T20	1.000
01070400020B	4	20	T20	1.000
01070400025B	4	25	T20	1.000
01070400030B	4	30	T20	1.000
01070400035B	4	35	T20	1.000
01070400040B	4	40	T20	1.000
01070400045B	4	45	T20	1.000
01070400050B	4	50	T20	500
01070400055B	4	55	T20	500
01070400060B	4	60	T20	500
01070400070B	4	70	T20	500
01070450016B	4,5	16	T25	1.000
01070450017B	4,5	17	T25	1.000
01070450020B	4,5	20	T25	1.000
01070450025B	4,5	25	T25	1.000
01070450030B	4,5	30	T25	1.000
01070450035B	4,5	35	T25	1.000
01070450040B	4,5	40	T25	1.000
01070450045B	4,5	45	T25	1.000
01070450050B	4,5	50	T25	500
01070450055B	4,5	55	T25	500
01070450060B	4,5	60	T25	500
01070450065B	4,5	65	T25	500
01070450070B	4,5	70	T25	500
01070450080B	4,5	80	T25	200
01070450090B	4,5	90	T25	200

CÓDIGO	(d)	L	⊗	ENWASE
01070450100B	4,5	100	T25	200
01070500020B	5	20	T25	1.000
01070500025B	5	25	T25	1.000
01070500030B	5	30	T25	1.000
01070500035B	5	35	T25	500
01070500040B	5	40	T25	500
01070500045B	5	45	T25	500
01070500050B	5	50	T25	500
01070500055B	5	55	T25	500
01070500060B	5	60	T25	500
01070500070B	5	70	T25	200
01070500080B	5	80	T25	200
01070500090B	5	90	T25	200
01070500100B	5	100	T25	200
01070600030B	6	30	T30	500
01070600035B	6	35	T30	500
01070600040B	6	40	T30	500
01070600045B	6	45	T30	200
01070600050B	6	50	T30	200
01070600060B	6	60	T30	200
01070600065B	6	65	T30	200
01070600070B	6	70	T30	200
01070600080B	6	80	T30	200
01070600090B	6	90	T30	200
01070600100B	6	100	T30	100
01070600120B	6	120	T30	100
01070600140B	6	140	T30	100
01070600160B	6	160	T30	100
01070600180B	6	180	T30	100
01070600200B	6	200	T30	100
01070800070B	8	70	T40	200
01070800080B	8	80	T40	200
01070800090B	8	90	T40	200
01070800100B	8	100	T40	100
01070800120B	8	120	T40	100
01070800140B	8	140	T40	100
01070800160B	8	160	T40	50
01070800180B	8	180	T40	50
01070800200B	8	200	T40	50
01070800250B	8	250	T40	50
01070800300B	8	300	T40	50
01070800350B	8	350	T40	50
01070800400B	8	400	T40	50
01071000200B	10	200	T40	50
01071000250B	10	250	T40	50
01071000300B	10	300	T40	50
01071000350B	10	350	T40	50
01071000400B	10	400	T40	50

Medidas en mm.

 Puntas de atornillar disponibles en página 272.

0107 KAT STAR 

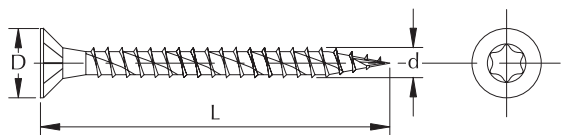

d mm	3	3,5	4	4,5	5	6	8	10
D mm	6	7	8	9	10	12	14	17

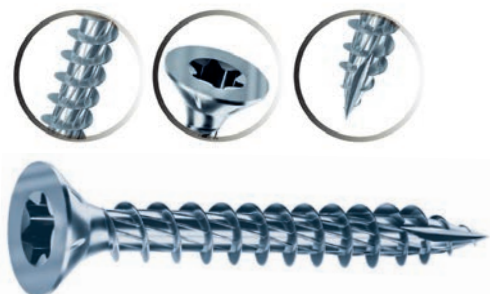

- Tornillo para la madera de gama alta.
- Huella hexalobular que mejora el agarre de la punta de atornillar.
- No necesita pretaladros en la mayoría de maderas.
- Punta fresada y sistema multicorte en espiral patentado: proporciona rápida inserción y mayor extracción de viruta.
- Cabeza reforzada para reducir torsión.
- Estrias adherentes bajo cabeza reducen riesgos de rotura en la madera.
- Con tratamiento térmico que aporta mayor dureza.

CÓDIGO	(d)	L	⊕	ENVASE
01070300010Z	3	10	T15	1.000
01070300012Z	3	12	T15	1.000
01070300013Z	3	13	T15	1.000
01070300015Z	3	15	T15	1.000
01070300016Z	3	16	T15	1.000
01070300017Z	3	17	T15	1.000
01070300020Z	3	20	T15	1.000
01070300025Z	3	25	T15	1.000
01070300030Z	3	30	T15	1.000
01070300035Z	3	35	T15	1.000
01070300040Z	3	40	T15	1.000
01070350012Z	3,5	12	T15	1.000
01070350013Z	3,5	13	T15	1.000
01070350015Z	3,5	15	T15	1.000
01070350016Z	3,5	16	T15	1.000
01070350017Z	3,5	17	T15	1.000
01070350020Z	3,5	20	T15	1.000
01070350025Z	3,5	25	T15	1.000
01070350030Z	3,5	30	T15	1.000
01070350035Z	3,5	35	T15	1.000
01070350040Z	3,5	40	T15	1.000
01070350045Z	3,5	45	T15	1.000
01070350050Z	3,5	50	T15	500
01070400012Z	4	12	T20	1.000
01070400015Z	4	15	T20	1.000
01070400016Z	4	16	T20	1.000
01070400017Z	4	17	T20	1.000
01070400020Z	4	20	T20	1.000
01070400025Z	4	25	T20	1.000
01070400030Z	4	30	T20	1.000
01070400035Z	4	35	T20	1.000
01070400040Z	4	40	T20	1.000
01070400045Z	4	45	T20	1.000
01070400050Z	4	50	T20	500
01070400055Z	4	55	T20	500
01070400060Z	4	60	T20	500
01070400070Z	4	70	T200	500
01070450016Z	4,5	16	T25	1.000
01070450017Z	4,5	17	T25	1.000
01070450020Z	4,5	20	T25	1.000
01070450025Z	4,5	25	T25	1.000
01070450030Z	4,5	30	T25	1.000
01070450035Z	4,5	35	T25	1.000
01070450040Z	4,5	40	T25	1.000
01070450045Z	4,5	45	T25	1.000
01070450050Z	4,5	50	T25	500
01070450055Z	4,5	55	T25	500
01070450060Z	4,5	60	T25	500
01070450065Z	4,5	65	T25	500
01070450070Z	4,5	70	T25	500

CÓDIGO	(d)	L	⊕	ENVASE
01070450080Z	4,5	80	T25	200
01070450090Z	4,5	90	T25	200
01070450100Z	4,5	100	T25	200
01070500020Z	5	20	T25	1.000
01070500025Z	5	25	T25	1.000
01070500030Z	5	30	T25	500
01070500035Z	5	35	T25	500
01070500040Z	5	40	T25	500
01070500045Z	5	45	T25	500
01070500050Z	5	50	T25	500
01070500055Z	5	55	T25	500
01070500060Z	5	60	T25	500
01070500070Z	5	70	T25	200
01070500080Z	5	80	T25	200
01070500090Z	5	90	T25	200
01070500100Z	5	100	T25	200
01070600030Z	6	30	T30	500
01070600035Z	6	35	T30	500
01070600040Z	6	40	T30	500
01070600045Z	6	45	T30	200
01070600050Z	6	50	T30	200
01070600060Z	6	60	T30	200
01070600070Z	6	70	T30	200
01070600080Z	6	80	T30	200
01070600090Z	6	90	T30	200
01070600100Z	6	100	T30	100
01070600120Z	6	120	T30	100
01070600140Z	6	140	T30	100
01070600160Z	6	160	T30	100
01070600180Z	6	180	T30	100
01070600200Z	6	200	T30	100
01070800070Z	8	70	T40	200
01070800080Z	8	80	T40	200
01070800090Z	8	90	T40	200
01070800100Z	8	100	T40	100
01070800120Z	8	120	T40	100
01070800140Z	8	140	T40	100
01070800160Z	8	160	T40	50
01070800180Z	8	180	T40	50
01070800200Z	8	200	T40	50
01070800250Z	8	250	T40	50
01070800300Z	8	300	T40	50
01070800350Z	8	350	T40	50
01070800400Z	8	400	T40	50
01071000200Z	10	200	T40	50
01071000250Z	10	250	T40	50
01071000300Z	10	300	T40	50
01071000350Z	10	350	T40	50
01071000400Z	10	400	T40	50

Medidas en mm.  Puntas de atornillar disponibles en página 272.

0108 KAT STAR PLUS ANTICORROSIÓN



d mm	5	6
D mm	10	12

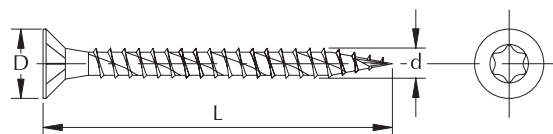

- Tornillo para la madera de gama alta.
- Huella hexalobular que mejora el agarre de la punta de atornillar.
- No necesita pretaladros en la mayoría de maderas.
- Punta fresada y sistema multicorte en espiral patentado: proporciona rápida inserción y mayor extracción de viruta.
- Cabeza reforzada para reducir torsión.
- Estrías adherentes bajo cabeza reducen riesgos de rotura en la madera.
- Recubrimiento anticorrosión 1000h CNS.
- Con tratamiento térmico que aporta mayor dureza.

Protección anticorrosiva según norma ASTM B117

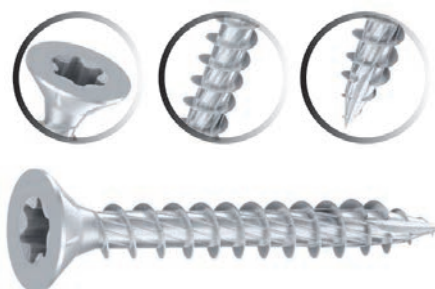

CÓDIGO	(d)	L	⊗	ENVASE
01080500040A	5	40	T25	500
01080500045A	5	45	T25	500
01080500050A	5	50	T25	500
01080500060A	5	60	T25	500
01080500070A	5	70	T25	200
01080500080A	5	80	T25	200
01080500090A	5	90	T25	200
01080500100A	5	100	T25	200
01080600060A	6	60	T25	200
01080600070A	6	70	T25	200
01080600080A	6	80	T25	200
01080600090A	6	90	T25	200
01080600100A	6	100	T25	100
01080600120A	6	120	T25	100
01080600140A	6	140	T25	100

CÓDIGO	(d)	L	⊗	ENVASE
01080600160A	6	160	T25	100
01080600180A	6	180	T25	100
01080600200A	6	200	T25	100
01080800070A	8	70	T40	200
01080800080A	8	80	T40	200
01080800090A	8	90	T40	100
01080800100A	8	100	T40	100
01080800120A	8	120	T40	100
01080800140A	8	140	T40	100
01080800160A	8	160	T40	50
01080800180A	8	180	T40	50
01080800200A	8	200	T40	50
01080800250A	8	250	T40	50
01080800300A	8	300	T40	50

0109 KAT STAR EMBELLECEDOR



d mm	7
D mm	16
K mm	4

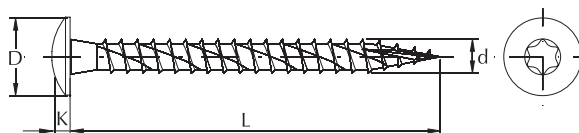

- Tornillo para la madera de gama alta.
- Huella hexalobular que mejora el agarre de la punta de atornillar.
- No necesita pretaladros en la mayoría de maderas.
- Punta fresada y sistema multicorte en espiral patentado: proporciona rápida inserción y mayor extracción de viruta.
- Cabeza reforzada para reducir torsión.
- Cabeza embellecedor reforzada para reducir torsión y proporcionar mejor apriete.
- Con tratamiento térmico que aporta mayor dureza.



CÓDIGO	(d)	L	⊗	ENVASE
01090700030B	7	30	T3	200
01090700040B	7	40	T3	200
01090700050B	7	50	T3	200
01090700060B	7	60	T3	200
01090700070B	7	70	T3	200

CÓDIGO	(d)	L	⊗	ENVASE
01090700080B	7	80	T3	100
01090700100B	7	100	T3	100
01090700120B	7	120	T3	100
01090700160B	7	160	T3	100
01090700200B	7	200	T3	100

Medidas en mm.

Puntas de atornillar disponibles en página 272.

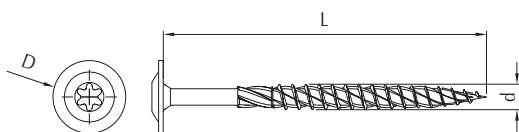
0146 KAT STAR CON ARANDELA 

d	6	8	10
D	14,5	23,5	26,5
STAR	T30	T40	T40



- Tornillo para la madera de gama alta.
- Huella hexalobular que mejora el agarre.
- No necesita pretaladros en la mayoría de maderas.
- Punta fresada que proporciona rápida inserción y mayor extracción de viruta.
- Cabeza con arandela estampada permite repartir la fuerza sobre la superficie de apoyo. Ideal para estructuras de madera.
- Con tratamiento térmico.

CÓDIGO	(d)	L	☼	ENVASE
01460600080Z	6	80	T30	200
01460600100Z	6	100	T30	100
01460600120Z	6	120	T30	100
01460600140Z	6	140	T30	100
01460600160Z	6	160	T30	100
01460600180Z	6	180	T30	100
01460600200Z	6	200	T30	100
01460800060Z	8	60	T40	100
01460800080Z	8	80	T40	50
01460800100Z	8	100	T40	50
01460800120Z	8	120	T40	50
01460800140Z	8	140	T40	50
01460800160Z	8	160	T40	50

CÓDIGO	(d)	L	☼	ENVASE
01460800180Z	8	180	T40	50
01460800200Z	8	200	T40	50
01460800220Z	8	220	T40	50
01460800240Z	8	240	T40	50
01460800260Z	8	260	T40	50
01460800280Z	8	280	T40	50
01460800300Z	8	300	T40	50
01461000200Z	10	200	T40	50
01461000300Z	10	300	T40	25
01461000360Z	10	360	T40	25
01461000400Z	10	400	T40	25





Cabeza con arandela estampada permite repartir la fuerza sobre la superficie de apoyo. Ideal para estructuras de madera.



Espiral NEX para la mejor unión entre módulos.



Sistema multicorte en espiral patentado que proporciona rápida inserción y mayor extracción de viruta.

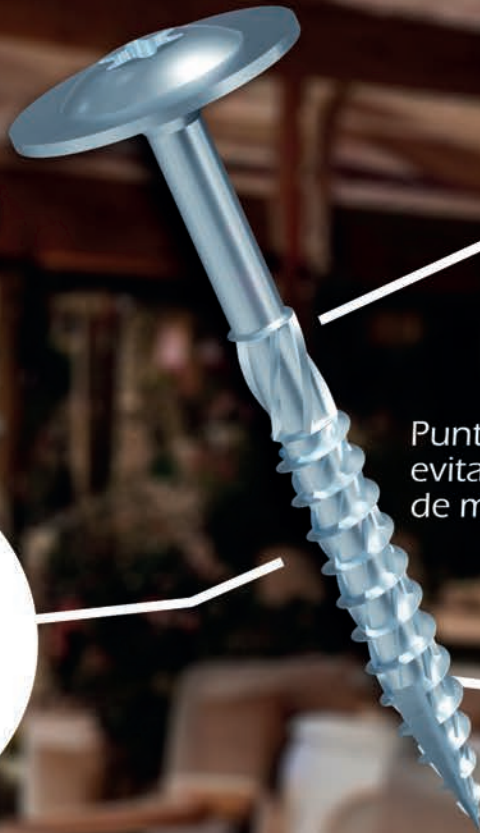

Punta taladrante con cuchilla, evita pretaladros en la mayoría de maderas.



**KaT**<sup>®</sup>

*El elegido por los profesionales de la madera*

Con estrías adherentes bajo la cabeza para reducir el riesgo de rotura del tablero.



**KaT**<sup>®</sup>  
STAR DM

Punta broca específica para DM



Espiral NEX para la mejor unión entre módulos.



**KaT**<sup>®</sup>

*El elegido por los profesionales de la madera*



0106 KAT POZI NEX 

d mm	3,5	4
D mm	7	8

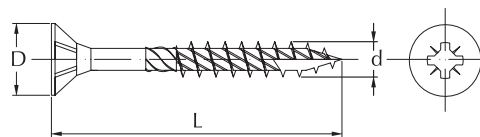

- Tornillo para la madera de gama alta.
- No necesita pretaladros en mayoría de maderas.
- Punta fresada y sistema multicorte en espiral patentado: proporciona rápida inserción y mayor extracción de viruta.
- Cabeza reforzada para reducir torsión.
- Estrías adherentes bajo cabeza reducen riesgos de rotura en la madera.
- Ideal para la unión de módulos gracias una segunda rosca de tipo vertical.
- Con tratamiento térmico que aporta mayor dureza.



CÓDIGO	(d)	L	+	ENVASE
01060350030Z	3,5	30/18	PZ2	1.000
01060350035Z	3,5	35/21	PZ2	1.000
01060350040Z	3,5	40/24	PZ2	1.000
01060350050Z	3,5	50/30	PZ2	500
01060350060Z	3,5	60/36	PZ2	500

CÓDIGO	(d)	L	+	ENVASE
01060400040Z	4	40/24	PZ2	500
01060400050Z	4	50/30	PZ2	500
01060400060Z	4	60/36	PZ2	500
01060500050Z	5	50/27	PZ2	500



CÓDIGO	(d)	L	+	ENVASE
01060500050B	5	50/27	PZ2	500

0141 KAT STAR DM 

d mm	3,5	4
D mm	5,5	6,5
K mm	3,5	4

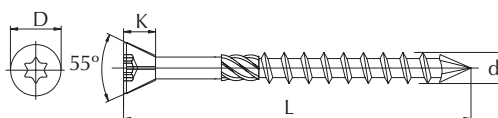

- Tornillo para DM de gama alta.
- Huella hexalobular que mejora el agarre.
- No necesita pretaladros.
- Punta broca, específica para DM y sistema multicorte en espiral: proporciona rápida inserción y mayor extracción de viruta.
- Estrías adherentes y cabeza reducida para evitar roturas.
- Con tratamiento térmico.



CÓDIGO	(d)	L	+	ENVASE
01410350040Z	3,5	40	T15	500
01410350050Z	3,5	50	T15	500
01410400040Z	4	40	T20	500

CÓDIGO	(d)	L	+	ENVASE
01410400045Z	4	45	T20	500
01410400050Z	4	50	T20	500
01410400060Z	4	60	T20	500

Medidas en mm.  Puntas de atornillar disponibles en página 272.

0112 TORNILLO TRASERA

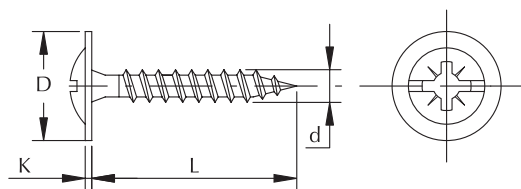

d mm	2,5	3	3,5	4
D mm	7	9	10	10
K mm	0,8	1	1	1,2



- Tornillo para la madera pozidrive con arandela incorporada.
- Al proporcionar una mayor superficie de contacto, el apriete es mejor.
- Con tratamiento térmico que aporta mayor dureza.

CÓDIGO	(d)	L	+	ENVASE
01120250013B	2,5	13	PZ1	2.000
01120250015B	2,5	15	PZ1	1.000
01120300013B	3	13	PZ2	1.000
01120300015B	3	15	PZ2	1.000
01120300020B	3	20	PZ2	1.000
01120300025B	3	25	PZ2	1.000
01120300030B	3	30	PZ2	1.000
01120350015B	3,5	15	PZ2	1.000
01120350020B	3,5	20	PZ2	1.000
01120350025B	3,5	25	PZ2	1.000

CÓDIGO	(d)	L	+	ENVASE
01120350030B	3,5	30	PZ2	1.000
01120350035B	3,5	35	PZ2	1.000
01120350040B	3,5	40	PZ2	1.000
01120400015B	4	15	PZ2	1.000
01120400020B	4	20	PZ2	1.000
01120400025B	4	25	PZ2	1.000
01120400030B	4	30	PZ2	1.000
01120400035B	4	35	PZ2	1.000
01120400040B	4	40	PZ2	1.000
01120400045B	4	45	PZ2	1.000



CÓDIGO	(d)	L	+	ENVASE
01120250013Z	2,5	13	PZ1	2.000
01120250015Z	2,5	15	PZ1	1.000
01120300013Z	3	13	PZ2	1.000
01120300015Z	3	15	PZ2	1.000
01120300020Z	3	20	PZ2	1.000
01120300025Z	3	25	PZ2	1.000
01120300030Z	3	30	PZ2	1.000
01120350015Z	3,5	15	PZ2	1.000
01120350020Z	3,5	20	PZ2	1.000
01120350025Z	3,5	25	PZ2	1.000
01120350030Z	3,5	30	PZ2	1.000

CÓDIGO	(d)	L	+	ENVASE
01120350035Z	3,5	35	PZ2	1.000
01120350040Z	3,5	40	PZ2	1.000
01120400013Z	4	13	PZ2	1.000
01120400015Z	4	15	PZ2	1.000
01120400020Z	4	20	PZ2	1.000
01120400025Z	4	25	PZ2	1.000
01120400030Z	4	30	PZ2	1.000
01120400035Z	4	35	PZ2	1.000
01120400040Z	4	40	PZ2	1.000
01120400045Z	4	45	PZ2	1.000

Consultar disponibilidad en otros recubrimientos.

0113 TORNILLO TRASERA ESTRIADO

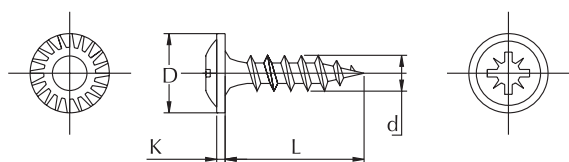

d mm	4
D mm	10
K mm	1,2



CÓDIGO	(d)	L	+	ENVASE
01130400013Z	4	13	PZ2	1.000

Medidas en mm.

Puntas de atornillar disponibles en página 272.

### 0139 TORNILLO ROSCA MADERA CON ARANDELA ESTRIADA ALLEN

d	6
D	13
K	3,2
C	1,3

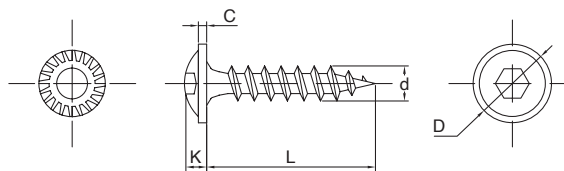

- Tornillo para la madera – utilizado en el ámbito de la sillería de oficina, entre otros - con huella hexagonal y arandela incorporada.
- Al proporcionar una mayor superficie de contacto, el apriete es mejor gracias a su estriado bajo cabeza.



CÓDIGO	(d)	L	⊕	ENVASE
01390600027Z	6	27	ALLEN 5	1.000

CÓDIGO	(d)	L	⊕	ENVASE
01390600035Z	6	35	ALLEN 5	1.000

### 0125 TORNILLO ROSCA AGLOMERADO GOTA SEBO PHILIPS

d mm	3	3,5
D mm	6	7

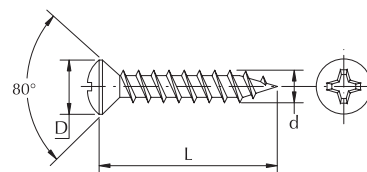

- Tornillo PH cabeza gota sebo.
- Uso para atornillado de manivelas, bisagras u otras uniones de herrajes a madera o aglomerado.
- Con tratamiento térmico.



CÓDIGO	(d)	L	⊕	ENVASE
01250300015Z	3	15	PH2	1.000
01250350015Z	3,5	15	PH2	1.000

CÓDIGO	(d)	L	⊕	ENVASE
01250350020Z	3,5	20	PH2	1.000
01250350025Z	3,5	25	PH2	1.000



CÓDIGO	(d)	L	⊕	ENVASE
01250350015Q	3,5	15	PH2	1.000



CÓDIGO	(d)	L	⊕	ENVASE
01250350025N	3,5	25	PH2	1.000



CÓDIGO	(d)	L	⊕	ENVASE
01250350025L	3,5	25	PH2	1.000



CÓDIGO	(d)	L	⊕	ENVASE
01250350025U	3,5	25	PH2	1.000

Consultar disponibilidad en otros recubrimientos.

### 0114 TORNILLO MANIVELA

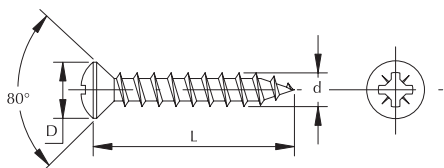

d mm	3,5	4
D mm	6,5	8



CÓDIGO	(d)	L	+	ENVASE
01140350015Q	3,5	15	PZ2	1.000
01140350020Q	3,5	20	PZ2	1.000

- Tornillo pozidrive cabeza gota sebo.
- Uso para atornillado de manivelas, bisagras u otras uniones de herrajes a madera.
- Con tratamiento térmico que aporta mayor dureza.

CÓDIGO	(d)	L	+	ENVASE
01140350025Q	3,5	25	PZ2	1.000
01140400016Q	4	16	PZ2	1.000



CÓDIGO	(d)	L	+	ENVASE
01140350020L	3,5	20	PZ2	1.000

CÓDIGO	(d)	L	+	ENVASE
01140350025L	3,5	25	PZ2	1.000



CÓDIGO	(d)	L	+	ENVASE
01140350025U	3,5	25	PZ2	1.000

Consultar disponibilidad en otros recubrimientos.

### 0111 TORNILLO UNIÓN COCINA

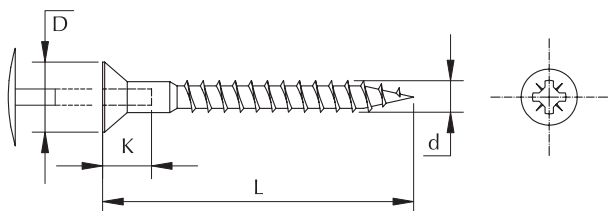

d mm	4,5
D mm	9
K mm	8



CÓDIGO	(d)	L	+	ENVASE
01110450030Z	4,5	30	PZ2	1.000
01110450035Z	4,5	35	PZ2	1.000

- Tornillo pozidrive para unión de módulos de cocina.
- Agujero en la cabeza para la colocación del tapón de plástico en supuestos de tornillo "visto".
- Con tratamiento térmico que aporta mayor dureza.

CÓDIGO	(d)	L	+	ENVASE
01110450040Z	4,5	40	PZ2	1.000
01110450050Z	4,5	50	PZ2	500

### 1017 TAPÓN UNIÓN COCINA



CÓDIGO	(d)	L	ENVASE
101711000001	11	BLANCO	1000
101711000004	11	MARRÓN	1000

CÓDIGO	(d)	L	ENVASE
101711000005	11	ROBLE	1000

Medidas en mm.

Puntas de atornillar disponibles en página 272.

**0117 TORNILLO ENSAMBLAJE ALLEN ROSCA GOLOSA CON PUNTA**

d mm	5	7
D mm	8	10
M mm	5	7
S mm	3	4

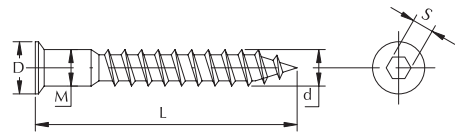

- Tornillo con huella hexagonal para montaje de muebles.
- Requiere de taladro previo.
- Mejor inserción si el taladro no es muy profundo.



CÓDIGO	(d)	L	○	ENVASE
01170500040B	5	40	ALLEN 3	500
01170500050B	5	50	ALLEN 3	500

CÓDIGO	(d)	L	○	ENVASE
01170700040B	7	40	ALLEN 4	500
01170700070B	7	70	ALLEN 4	200

CÓDIGO	(d)	L	○	ENVASE
01170500040Z	5	40	ALLEN 3	500
01170500050Z	5	50	ALLEN 3	500
01170500060Z	5	60	ALLEN 3	500
01170700040Z	7	40	ALLEN 4	500



CÓDIGO	(d)	L	○	ENVASE
01170700050Z	7	50	ALLEN 4	500
01170700060Z	7	60	ALLEN 4	500
01170700070Z	7	70	ALLEN 4	200

CÓDIGO	(d)	L	○	ENVASE
01170500040N	5	40	ALLEN 3	500
01170500050N	5	50	ALLEN 3	500
01170700040N	7	40	ALLEN 4	500



CÓDIGO	(d)	L	○	ENVASE
01170700050N	7	50	ALLEN 4	500
01170700060N	7	60	ALLEN 4	500
01170700070N	7	70	ALLEN 4	200

Consultar disponibilidad en otras medidas y recubrimientos.

**0118 TORNILLO EMBELLECEDOR ALLEN ROSCA GOLOSA SIN PUNTA**

d mm	7
D mm	14
M mm	7
S mm	4

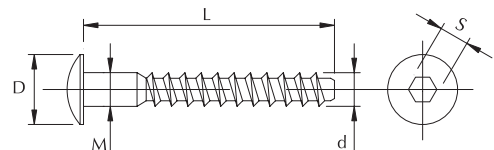

- Tornillo cabeza embellecedor con huella hexagonal para montaje de muebles.
- Requiere de taladro previo.



CÓDIGO	(d)	L	○	ENVASE
01180700025B	7	25	ALLEN 4	2.000
01180700035B	7	35	ALLEN 4	1.000
01180700040B	7	40	ALLEN 4	1.000

CÓDIGO	(d)	L	○	ENVASE
01180700045B	7	45	ALLEN 4	1.000
01180700050B	7	50	ALLEN 4	500
01180700100B	7	100	ALLEN 4	500

0116 TORNILLO ENSAMBLAJE ALLEN ROSCA GOLOSA SIN PUNTA

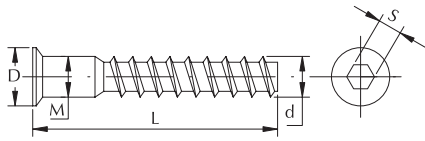

d mm	7
D mm	10
M mm	7
S mm	4



- Tornillo con huella hexagonal para montaje de muebles.
- Requiere de taladro previo.

CÓDIGO	(d)	L	○	ENVASE
01160700025B	7	25	ALLEN 4	500
01160700030B	7	30	ALLEN 4	500
01160700040B	7	40	ALLEN 4	500
01160700045B	7	45	ALLEN 4	500

CÓDIGO	(d)	L	○	ENVASE
01160700050B	7	50	ALLEN 4	500
01160700060B	7	60	ALLEN 4	500
01160700070B	7	70	ALLEN 4	200



CÓDIGO	(d)	L	○	ENVASE
01160700025Z	7	25	ALLEN 4	500
01160700040Z	7	40	ALLEN 4	500
01160700050Z	7	50	ALLEN 4	500

CÓDIGO	(d)	L	○	ENVASE
01160700060Z	7	60	ALLEN 4	500
01160700070Z	7	70	ALLEN 4	200



CÓDIGO	(d)	L	○	ENVASE
01160700025N	7	25	ALLEN 4	500
01160700040N	7	40	ALLEN 4	500
01160700050N	7	50	ALLEN 4	500

CÓDIGO	(d)	L	○	ENVASE
01160700055N	7	55	ALLEN 4	500
01160700060N	7	60	ALLEN 4	500
01160700070N	7	70	ALLEN 4	200

### 0119 TORNILLO ENSAMBLAJE ALLEN ROSCA GOLOSA CAB. AVELLANADA SIN PUNTA

d mm	7
D mm	11
K mm	4

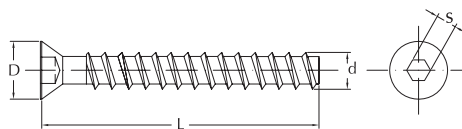

- Tornillo con huella hexagonal para unión de muebles.
- No requiere de tuerca émbolo; directamente a madera.
- Requiere de taladro previo.



CÓDIGO	(d)	L	○	ENVASE
01190700055Z	7	55	ALLEN 4	500

### 0115 TORNILLO ENSAMBLAJE ALLEN ROSCA 1/4" SIN PUNTA

d mm	1/4"
D mm	11
M mm	8
S mm	4

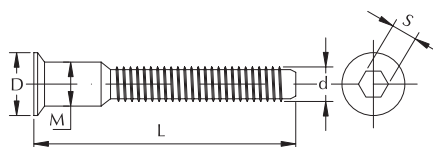

- Tornillo con huella hexagonal para unión de muebles.
- Habitualmente utilizado con la tuerca émbolo 1/4".
- Requiere de taladro previo.



CÓDIGO	(d)	L	○	ENVASE
01150140030B	1/4"	30	ALLEN 4	250
01150140040B	1/4"	40	ALLEN 4	250
01150140045B	1/4"	45	ALLEN 4	250

CÓDIGO	(d)	L	○	ENVASE
01150140050B	1/4"	50	ALLEN 4	250
01150140055B	1/4"	55	ALLEN 4	250

CÓDIGO	(d)	L	○	ENVASE
01150140040N	1/4"	40	ALLEN 4	250
01150140045N	1/4"	45	ALLEN 4	250
01150140050N	1/4"	50	ALLEN 4	250

CÓDIGO	(d)	L	○	ENVASE
01150140055N	1/4"	55	ALLEN 4	250
01150140060N	1/4"	60	ALLEN 4	250



Consultar disponibilidad en otros recubrimientos.



### 0133 TORNILLO ENGANCHE SIN PUNTA

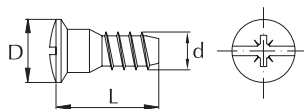

d mm	6,3
D mm	10



- Tornillo para unión de módulos y estanterías.
- Habitualmente utilizado con el soporte enganche.

CÓDIGO	(d)	L	+	ENVASE
01330630012Z	6,3	12	PZ2	1.000

CÓDIGO	(d)	L	+	ENVASE
01330630015Z	6,3	15	PZ2	1.000

Soporte enganche disponible en página 233.

### 0140 TORNILLO ENGANCHE CON PUNTA

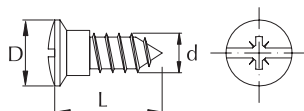

d mm	4,5
D mm	10



- Tornillo para unión de módulos y estanterías.
- Habitualmente utilizado con el soporte enganche.

CÓDIGO	(d)	L	+	ENVASE
01400450016Z	4,5	16	PZ2	1.000

Soporte enganche disponible en página 233.

### 0134 TORNILLO EURO

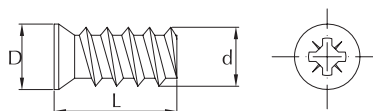

d mm	6,3
D mm	7



- Tornillo para atornillado de guías de los cajones.
- Sus prestaciones lo convierten en el más utilizado del mercado.

CÓDIGO	(d)	L	+	ENVASE
01340630009Z	6,3	9	PZ2	1.000
01340630011Z	6,3	11	PZ2	1.000
01340630013Z	6,3	13	PZ2	1.000

CÓDIGO	(d)	L	+	ENVASE
01340630017Z	6,3	17	PZ2	1.000
01340630025Z	6,3	25	PZ2	1.000

### 0135 TORNILLO EURO ROSCA PLÁSTICO

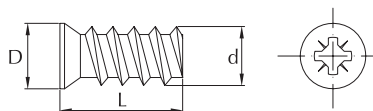

d mm	4,1
D mm	6,5



- Tornillo para atornillado de guías de los cajones.

CÓDIGO	(d)	L	+	ENVASE
01350410008Z	4,1	8	PZ2	1.000

CÓDIGO	(d)	L	+	ENVASE
01350410010Z	4,1	10	PZ2	1.000

Medidas en mm.

 Puntas de atornillar disponibles en página 272.



## 0120 DIN 571

d mm	5	6	7	8	10	12
K mm	3	4	5	5,5	7	8
S mm	8	10	12	13	17	19

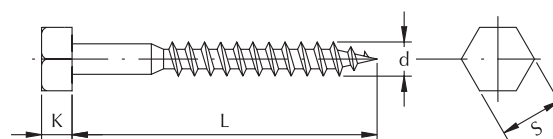

- Tirafondo barraquero para la madera.
- Utilizado en amplia variedad de instalaciones y montajes de construcción junto con taco nylon.



CÓDIGO	(d)	L	ENVASE
01200500025Z	5	25	500
01200500030Z	5	30	500
01200500035Z	5	35	500
01200500040Z	5	40	500
01200500045Z	5	45	500
01200500050Z	5	50	500
01200500060Z	5	60	500
01200600025Z	6	25	500
01200600030Z	6	30	500
01200600035Z	6	35	500
01200600040Z	6	40	500
01200600045Z	6	45	500
01200600050Z	6	50	500
01200600060Z	6	60	250
01200600070Z	6	70	200
01200600080Z	6	80	200
01200600090Z	6	90	200
01200600100Z	6	100	200
01200600110Z	6	110	200
01200600120Z	6	120	200
01200700030Z	7	30	500
01200700035Z	7	35	300
01200700040Z	7	40	500
01200700045Z	7	45	250
01200700050Z	7	50	200
01200700060Z	7	60	200
01200700070Z	7	70	200
01200700080Z	7	80	200
01200700090Z	7	90	200
01200700100Z	7	100	200
01200700110Z	7	110	200
01200700120Z	7	120	200
01200800030Z	8	30	200
01200800035Z	8	35	300
01200800040Z	8	40	200
01200800045Z	8	45	200
01200800050Z	8	50	200
01200800060Z	8	60	100
01200800070Z	8	70	100
01200800080Z	8	80	100

CÓDIGO	(d)	L	ENVASE
01200800090Z	8	90	100
01200800100Z	8	100	100
01200800110Z	8	110	100
01200800120Z	8	120	50
01200800130Z	8	130	50
01200800140Z	8	140	50
01200800150Z	8	150	50
01200800160Z	8	160	50
01200800180Z	8	180	50
01200800200Z	8	200	50
01201000040Z	10	40	50
01201000045Z	10	45	50
01201000050Z	10	50	50
01201000060Z	10	60	50
01201000070Z	10	70	50
01201000080Z	10	80	50
01201000090Z	10	90	50
01201000100Z	10	100	50
01201000110Z	10	110	25
01201000120Z	10	120	25
01201000130Z	10	130	25
01201000140Z	10	140	50
01201000150Z	10	150	25
01201000160Z	10	160	25
01201000180Z	10	180	25
01201000200Z	10	200	25
01201200050Z	12	50	25
01201200060Z	12	60	25
01201200070Z	12	70	25
01201200080Z	12	80	25
01201200090Z	12	90	25
01201200100Z	12	100	25
01201200110Z	12	110	25
01201200120Z	12	120	25
01201200130Z	12	130	25
01201200140Z	12	140	25
01201200150Z	12	150	25
01201200160Z	12	160	25
01201200180Z	12	180	25
01201200200Z	12	200	25

Consultar disponibilidad en otros recubrimientos.

0121 DIN 571 CALIDAD 8.8

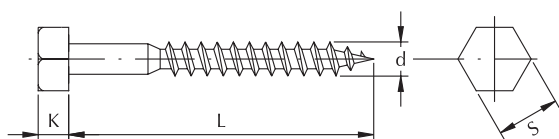

d mm	5	6	7	8	10
K mm	3	4	5	5,5	7
S mm	8	10	12	13	17



- Tirafondo barraquero para la madera de calidad 8.8.
- Con tratamiento térmico.
- Utilizado en amplia variedad de instalaciones y montajes de construcción.
- Su dureza proporciona mayor fiabilidad en los diferentes montajes constructivos que requieren un tornillo de mejores prestaciones y resistencia.

CÓDIGO	(d)	L	ENVASE
01210500035Z	5	35	500
01210600045Z	6	45	500
01210600050Z	6	50	500
01210600060Z	6	60	250
01210600070Z	6	70	200
01210600090Z	6	90	200
01210700050Z	7	50	250
01210700060Z	7	60	250
01210700070Z	7	70	100
01210700080Z	7	80	100
01210700090Z	7	90	100
01210800040Z	8	40	200
01210800050Z	8	50	150
01210800060Z	8	60	100
01210800070Z	8	70	100
01210800080Z	8	80	100

CÓDIGO	(d)	L	ENVASE
01210800090Z	8	90	100
01210800100Z	8	100	100
01210800120Z	8	120	100
01210800140Z	8	140	50
01211000060Z	10	60	100
01211000070Z	10	70	100
01211000080Z	10	80	100
01211000090Z	10	90	100
01211000100Z	10	100	50
01211000110Z	10	110	50
01211000120Z	10	120	50
01211000130Z	10	130	50
01211000140Z	10	140	50
01211000150Z	10	150	50
01211000160Z	10	160	50

0122 DIN 571 CON ARANDELA CALIDAD 8.8

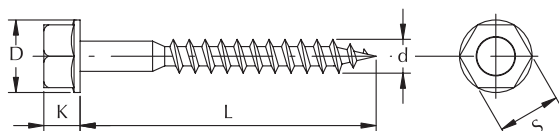

d mm	6
D mm	13
K mm	5
S mm	10



- Tirafondo barraquero para la madera de calidad 8.8 y arandela estampada.
- Con tratamiento térmico.
- Utilizado en amplia variedad de instalaciones y montajes de construcción.
- Su dureza proporciona mayor fiabilidad en los diferentes montajes que requieren un tornillo de mejores prestaciones y resistencia.

CÓDIGO	(d)	L	ENVASE
01220600030Z	6	30	500
01220600040Z	6	40	500
01220600050Z	6	50	500

CÓDIGO	(d)	L	ENVASE
01220600060Z	6	60	200
01220600070Z	6	70	200
01220600080Z	6	80	200

Medidas en mm.

## 0138 TORNILLO INVIOLEABLE

d mm	7
D mm	17

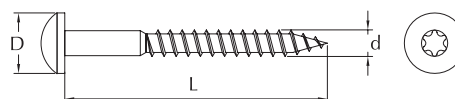

- Tornillo rosca madera con huella hexalobular que mejora el agarre de la punta de atornillar.
- Estrella de seguridad incluida.
- Utilizado en montajes que requieran este tipo de tornillo que evita la opción de ser desenroscado, particularmente en colocación de enrejados.



CÓDIGO	(d)	L	☼	ENVASE
01380600040Z	6	40	T40	100
01380600050Z	6	50	T40	100
01380600060Z	6	60	T40	100
01380600070Z	6	70	T40	100
01380700030Z	7	30	T40	100
01380700040Z	7	40	T40	100

CÓDIGO	(d)	L	☼	ENVASE
01380700050Z	7	50	T40	100
01380700060Z	7	60	T40	100
01380700070Z	7	70	T40	100
01380700080Z	7	80	T40	100
01380700090Z	7	90	T40	100
01380700120Z	7	120	T40	100



CÓDIGO	(d)	L	☼	ENVASE
01380600040N	6	40	T40	100
01380600050N	6	50	T40	100
01380600060N	6	60	T40	100
01380600070N	6	70	T40	100
01380700030N	7	30	T40	100
01380700040N	7	40	T40	100

CÓDIGO	(d)	L	☼	ENVASE
01380700050N	7	50	T40	100
01380700060N	7	60	T40	100
01380700070N	7	70	T40	100
01380700080N	7	80	T40	100
01380700090N	7	90	T40	100

## 0126 ESPÁRRAGO DOWEL

D	1/8"	5/32"	M4	M5	1/4"	M6	M8	M10
d mm	3,5	4,2	4,2	5,5	6,5	6,5	8,5	10,5

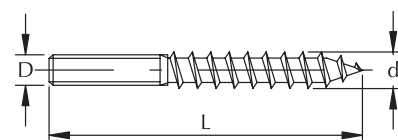

- Espárrago doble rosca, métrica y madera para ensamblaje de diferentes partes de mobiliario.
- Habitualmente utilizados con tuercas de embutir o tuercas 4 púas.



CÓDIGO	(d)	L	ENVASE
01260400015Z	M4	15	1.000
01260400020Z	M4	20	1.000
01260400025Z	M4	25	1.000
01260400030Z	M4	30	1.000
01260400035Z	M4	35	1.000
01260500030Z	M5	30	500
01260500035Z	M5	35	500
01260600040Z	M6	40	500
01260600050Z	M6	50	200
01260600060Z	M6	60	200
01260600070Z	M6	70	200
01260800040Z	M8	40	200
01260800050Z	M8	50	200
01260800060Z	M8	60	200
01260800070Z	M8	70	200
01260800080Z	M8	80	200

CÓDIGO	(d)	L	ENVASE
01260800090Z	M8	90	200
01260800100Z	M8	100	100
01260800120Z	M8	120	100
01260800140Z	M8	140	100
01261000050Z	M10	50	200
01261000060Z	M10	60	200
01261000090Z	M10	90	100
01261000100Z	M10	100	100
01260180015Z	1/8"	15	1.000
01265320020Z	5/32"	20	1.000
01260140035Z	1/4"	35	500
01260140040Z	1/4"	40	500
01260140050Z	1/4"	50	200
01260140060Z	1/4"	60	200
01260140070Z	1/4"	70	200
01260140080Z	1/4"	80	200

Medidas en mm.

Puntas de atornillar disponibles en página 272.

### 0127 ESPÁRRAGO DOWEL CON HEXÁGONO

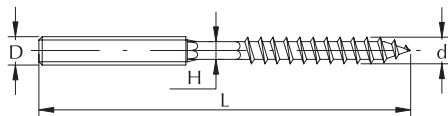

D	M8
d mm	7
H mm	6



CÓDIGO	(d)	L	ENVASE
01270800100Z	M8	100	100
01270800120Z	M8	120	100
01271000120Z	M10	120	50



CÓDIGO	(d)	L	ENVASE
01270800120B	M8	120	100

- Espárrago doble rosca, métrica y madera para ensamblaje de muebles.
- Hexágono central para facilitar el atornillado.
- Habitualmente utilizados con tuercas de embutir o tuercas 4 púas.

### 0129 ESPÁRRAGO ROSCA MADERA

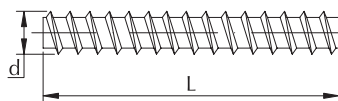

CÓDIGO	(d)	L	ENVASE
01290800060Z	8	60	200
01290800070Z	8	70	200

- Espárrago rosca madera para ensamblaje de muebles o piezas de madera.

CÓDIGO	(d)	L	ENVASE
01290800075Z	8	75	200

### 0130 ESPÁRRAGO DOBLE ROSCA MADERA

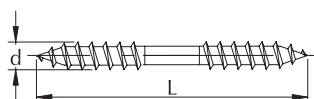

CÓDIGO	(d)	L	ENVASE
01300400040Z	4	40	1.000

- Espárrago doble rosca madera para ensamblaje de muebles o piezas de madera.

### 0131 ESPÁRRAGO DOBLE ROSCA MADERA CON HEXÁGONO

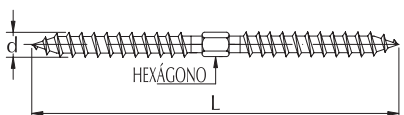

CÓDIGO	(d)	L	ENVASE
01310800100Z	8	100	100
01310800120Z	8	120	100

- Espárrago doble rosca madera para ensamblaje de muebles.
- Hexágono en la parte central facilita el atornillado.

Medidas en mm.

0136 TORNILLO ABRAZADERA

D	M6	M6	M6	M8
d mm	5	5	5,5	6,3
K mm	6	8	8	9
M mm	30	30	36	35
L mm	36	38	44	44
N mm	8	8	9	9

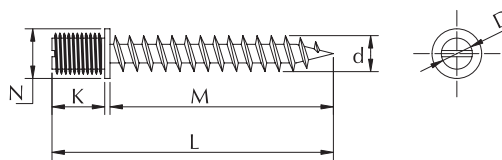

- Tornillo para el apriete de abrazaderas.



CÓDIGO	(d)	L	ENVASE
01360665030B	M6 / 5	6-30	500
01360685030B	M6 / 5	8-30	500
01360685536B	M6 / 5,5	8-36	500



CÓDIGO	(d)	L	ENVASE
01360896335Z	M8 / 6,3	9-35	200

0123 DIN 96

d mm	2,4
D mm	4
K mm	1,5

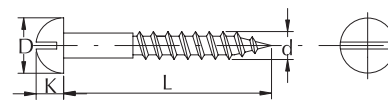

- Tornillo para la madera con cabeza redonda ranurada.



CÓDIGO	(d)	L	ENVASE
01230240010Q	2,4	10	1.000
01230240013Q	2,4	13	1.000
01230240015Q	2,4	15	1.000



CÓDIGO	(d)	L	ENVASE
01230240010L	2,4	10	1.000
01230240013L	2,4	13	1.000
01230240017L	2,4	17	1.000



CÓDIGO	(d)	L	ENVASE
01230240010U	2,4	10	1.000



CÓDIGO	(d)	L	ENVASE
01230240013P	2,4	13	1.000
01230240015P	2,4	15	1.000

0137 TORNILLO ROSCA AGLOMERADO RANURADO

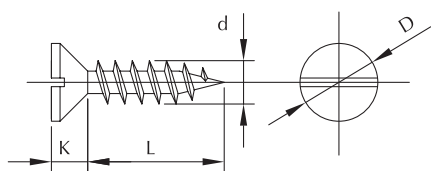

d mm	2,3	2,5	3	3,5	4	4,5	5
D mm	4,5	5,3	6	7	7,7	8,7	9
K mm	2	2	2,5	2,5	2,7	3	3,5



- Tornillo aglomerado para la madera con cabeza avellanada ranurada.

CÓDIGO	(d)	L	ENVASE
01370230010Z	2,3	10	1.000
01370230015Z	2,3	15	1.000
01370230017Z	2,3	17	1.000
01370230020Z	2,3	20	1.000
01370250013Z	2,5	13	1.000
01370250015Z	2,5	15	1.000
01370250016Z	2,5	16	1.000
01370250017Z	2,5	17	1.000
01370250020Z	2,5	20	1.000
01370250025Z	2,5	25	1.000
01370250030Z	2,5	30	1.000
01370300013Z	3	13	1.000
01370300016Z	3	16	1.000
01370300022Z	3	22	1.000
01370300025Z	3	25	1.000
01370300030Z	3	30	1.000
01370300035Z	3	35	1.000
01370300040Z	3	40	1.000
01370350017Z	3,5	17	1.000
01370350020Z	3,5	20	1.000
01370350030Z	3,5	30	1.000
01370350035Z	3,5	35	1.000

CÓDIGO	(d)	L	ENVASE
01370350040Z	3,5	40	1.000
01370350045Z	3,5	45	1.000
01370350050Z	3,5	50	1.000
01370350080Z	3,5	80	500
01370400013Z	4	13	1.000
01370400015Z	4	15	1.000
01370400020Z	4	20	1.000
01370400025Z	4	25	1.000
01370400035Z	4	35	1.000
01370400040Z	4	40	1.000
01370400045Z	4	45	500
01370400050Z	4	50	500
01370450020Z	4,5	20	1.000
01370450025Z	4,5	25	1.000
01370450035Z	4,5	35	1.000
01370450040Z	4,5	40	1.000
01370450060Z	4,5	60	500
01370500020Z	5	20	1.000
01370500025Z	5	25	1.000
01370500030Z	5	30	1.000
01370500035Z	5	35	1.000
01370500055Z	5	55	500

0124 DIN 97

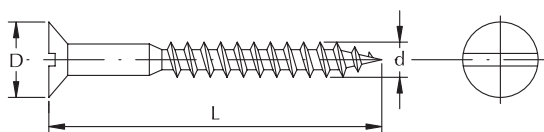

d mm	2,5	3	3,5	4	4,5	5
D mm	5,5	6	7	8	9	9,5



- Tornillo para la madera con cabeza avellanada ranurada.

CÓDIGO	(d)	L	ENVASE
01240250017Z	2,5	17	1.000
01240250025Z	2,5	25	1.000
01240300020Z	3	20	1.000
01240300025Z	3	25	1.000
01240350015Z	3,5	15	1.000
01240350018Z	3,5	18	1.000
01240350030Z	3,5	30	1.000
01240350035Z	3,5	35	1.000
01240400020Z	4	20	1.000
01240400025Z	4	25	1.000
01240400050Z	4	50	500
01240450022Z	4,5	22	1.000
01240450025Z	4,5	25	1.000

CÓDIGO	(d)	L	ENVASE
01240450030Z	4,5	30	1.000
01240450035Z	4,5	35	1.000
01240450040Z	4,5	40	1.000
01240450045Z	4,5	45	500
01240450050Z	4,5	50	500
01240450055Z	4,5	55	500
01240450060Z	4,5	60	500
01240450065Z	4,5	65	500
01240450070Z	4,5	70	500
01240500060Z	5	60	500
01240500070Z	5	70	200
01240500090Z	5	90	200

Medidas en mm.



**TORNILLOS  
ROSCA MÉTRICA**

**02**

0201 DIN 603 CON TUERCA DIN 934

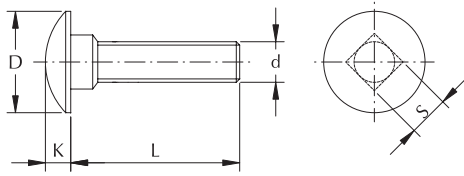

d	M5	M6	M7	M8	M10	M12	1/4"
D	13	16	18	20	24	30	15
K	3	3,5	4	4,5	5	6,5	3,2
S	5	6	7	8	10	12	6,5

- Tornillo carroceros de cabeza redonda y cuello cuadrado.
- Destinado a uniones de dos piezas, sean madera u otro material.
- Con tuerca hexagonal incluida.

CÓDIGO	(d)	L	ENVASE
02010500016Z	M5	16	200
02010500020Z	M5	20	200
02010500025Z	M5	25	200
02010500030Z	M5	30	200
02010500035Z	M5	35	200
02010500040Z	M5	40	200
02010500045Z	M5	45	200
02010500050Z	M5	50	200
02010500055Z	M5	55	200
02010500060Z	M5	60	200
02010500070Z	M5	70	200
02010500080Z	M5	80	200
02010600015Z	M6	15	200
02010600020Z	M6	20	200
02010600023Z	M6	23	200
02010600025Z	M6	25	200
02010600030Z	M6	30	200
02010600035Z	M6	35	200
02010600040Z	M6	40	200
02010600045Z	M6	45	200
02010600050Z	M6	50	200
02010600055Z	M6	55	200
02010600060Z	M6	60	200
02010600070Z	M6	70	200
02010600080Z	M6	80	200
02010600090Z	M6	90	200
02010600100Z	M6	100	200
02010600110Z	M6	110	100
02010600120Z	M6	120	100
02010600130Z	M6	130	100
02010600140Z	M6	140	100
02010600150Z	M6	150	100
02010700030Z	M7	30	200
02010700035Z	M7	35	200
02010700040Z	M7	40	200
02010700050Z	M7	50	200
02010700055Z	M7	55	100
02010700060Z	M7	60	100
02010700070Z	M7	70	100
02010700080Z	M7	80	100
02010700110Z	M7	110	100
02010800015Z	M8	15	200
02010800020Z	M8	20	200
02010800025Z	M8	25	200
02010800030Z	M8	30	200
02010800035Z	M8	35	200
02010800040Z	M8	40	100
02010800045Z	M8	45	100
02010800050Z	M8	50	100
02010800055Z	M8	55	100
02010800060Z	M8	60	100
02010800065Z	M8	65	100
02010800070Z	M8	70	100
02010800080Z	M8	80	100
02010800090Z	M8	90	100
02010800100Z	M8	100	100
02010800110Z	M8	110	100

CÓDIGO	(d)	L	ENVASE
02010800120Z	M8	120	50
02010800130Z	M8	130	100
02010800140Z	M8	140	100
02010800150Z	M8	150	100
02011000020Z	M10	20	100
02011000025Z	M10	25	100
02011000030Z	M10	30	200
02011000035Z	M10	35	100
02011000040Z	M10	40	100
02011000045Z	M10	45	100
02011000050Z	M10	50	100
02011000055Z	M10	55	100
02011000060Z	M10	60	100
02011000070Z	M10	70	100
02011000080Z	M10	80	100
02011000090Z	M10	90	100
02011000095Z	M10	95	100
02011000100Z	M10	100	100
02011000110Z	M10	110	50
02011000120Z	M10	120	50
02011000130Z	M10	130	50
02011000140Z	M10	140	50
02011000150Z	M10	150	50
02011000160Z	M10	160	50
02011000180Z	M10	180	50
02011000190Z	M10	190	50
02011000200Z	M10	200	50
02011200025Z	M12	25	100
02011200030Z	M12	30	50
02011200035Z	M12	35	100
02011200040Z	M12	40	50
02011200045Z	M12	45	50
02011200050Z	M12	50	50
02011200055Z	M12	55	50
02011200060Z	M12	60	50
02011200070Z	M12	70	50
02011200080Z	M12	80	50
02011200090Z	M12	90	50
02011200100Z	M12	100	50
02011200110Z	M12	110	25
02011200120Z	M12	120	50
02011200130Z	M12	130	25
02011200140Z	M12	140	25
02011200160Z	M12	160	25
02011200180Z	M12	180	25
02011200200Z	M12	200	25
02010140015Z	1/4"	15	200
02010140020Z	1/4"	20	200
02010140025Z	1/4"	25	200
02010140035Z	1/4"	35	200
02010140045Z	1/4"	45	200
02010140050Z	1/4"	50	200
02010140055Z	1/4"	55	200
02010140065Z	1/4"	65	100
02010140090Z	1/4"	90	100
02010140100Z	1/4"	100	100
02010140110Z	1/4"	110	100

Consultar disponibilidad en otras medidas.

Medidas en mm.



0202 DIN 603 SIN TUERCA

d	M5	M6	M7	M8	M10	M12	1/4"
D	13	16	18	20	24	30	15
K	3	3,5	4	4,5	5	6,5	3,2
S	5	6	7	8	10	12	6,5

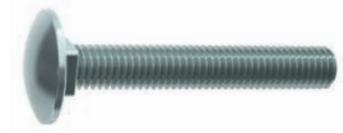
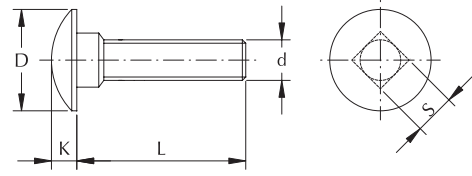

- Tornillo carroceros de cabeza redonda y cuello cuadrado.
- Destinado a uniones de dos piezas, sean madera u otro material.

CÓDIGO	(d)	L	ENVASE
02020500016Z	M5	16	200
02020500020Z	M5	20	500
02020500025Z	M5	25	200
02020500030Z	M5	30	200
02020500035Z	M5	35	200
02020500040Z	M5	40	200
02020500045Z	M5	45	200
02020500050Z	M5	50	200
02020500055Z	M5	55	200
02020500060Z	M5	60	200
02020500070Z	M5	70	200
02020500080Z	M5	80	200
02020600015Z	M6	15	200
02020600020Z	M6	20	200
02020600023Z	M6	23	200
02020600025Z	M6	25	200
02020600030Z	M6	30	200
02020600035Z	M6	35	200
02020600040Z	M6	40	200
02020600045Z	M6	45	200
02020600050Z	M6	50	200
02020600055Z	M6	55	200
02020600060Z	M6	60	200
02020600065Z	M6	65	100
02020600070Z	M6	70	200
02020600080Z	M6	80	200
02020600090Z	M6	90	200
02020600100Z	M6	100	200
02020600110Z	M6	110	100
02020600120Z	M6	120	100
02020600130Z	M6	130	100
02020600140Z	M6	140	100
02020600150Z	M6	150	100
02020700030Z	M7	30	200
02020700035Z	M7	35	200
02020700040Z	M7	40	200
02020700050Z	M7	50	200
02020700060Z	M7	60	100
02020700070Z	M7	70	100
02020700080Z	M7	80	100
02020700090Z	M7	90	100
02020700100Z	M7	100	100
02020800015Z	M8	15	200
02020800016Z	M8	16	200
02020800020Z	M8	20	200
02020800025Z	M8	25	200
02020800030Z	M8	30	200
02020800035Z	M8	35	200
02020800040Z	M8	40	100
02020800045Z	M8	45	100
02020800050Z	M8	50	100
02020800055Z	M8	55	100
02020800060Z	M8	60	100
02020800065Z	M8	65	100
02020800070Z	M8	70	100

CÓDIGO	(d)	L	ENVASE
02020800080Z	M8	80	100
02020800090Z	M8	90	100
02020800100Z	M8	100	100
02020800110Z	M8	110	100
02020800120Z	M8	120	50
02020800130Z	M8	130	100
02020800140Z	M8	140	100
02020800150Z	M8	150	100
02020800160Z	M8	160	100
02021000020Z	M10	20	100
02021000025Z	M10	25	100
02021000030Z	M10	30	200
02021000035Z	M10	35	100
02021000040Z	M10	40	100
02021000045Z	M10	45	100
02021000050Z	M10	50	100
02021000055Z	M10	55	100
02021000060Z	M10	60	100
02021000070Z	M10	70	100
02021000080Z	M10	80	100
02021000090Z	M10	90	100
02021000095Z	M10	95	400
02021000100Z	M10	100	100
02021000110Z	M10	110	50
02021000120Z	M10	120	50
02021000130Z	M10	130	50
02021000140Z	M10	140	50
02021000150Z	M10	150	50
02021000160Z	M10	160	50
02021000180Z	M10	180	50
02021000190Z	M10	190	50
02021000200Z	M10	200	50
02021200025Z	M12	25	100
02021200030Z	M12	30	50
02021200035Z	M12	35	100
02021200040Z	M12	40	50
02021200045Z	M12	45	50
02021200050Z	M12	50	50
02021200055Z	M12	55	50
02021200060Z	M12	60	50
02021200070Z	M12	70	25
02021200080Z	M12	80	50
02021200090Z	M12	90	25
02021200100Z	M12	100	50
02021200110Z	M12	110	25
02021200120Z	M12	120	50
02021200130Z	M12	130	25
02021200140Z	M12	140	25
02021200160Z	M12	160	25
02021200180Z	M12	180	25
02021200200Z	M12	200	25
02020140015Z	1/4"	15	200
02020140020Z	1/4"	20	200
02020140025Z	1/4"	25	200
02020140035Z	1/4"	35	200

Consultar disponibilidad en otras medidas.

Medidas en mm.

0202 DIN 603 SIN TUERCA

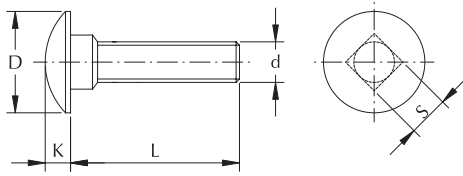

d	1/4"
D	15
K	3,2
S	6,5

02020140045Z	1/4"	45	200
02020140050Z	1/4"	50	200
02020140055Z	1/4"	55	200
02020140065Z	1/4"	65	100

02020140090Z	1/4"	90	100
02020140100Z	1/4"	100	100
02020140110Z	1/4"	110	100

0201 DIN 603 CON TUERCA DIN 934

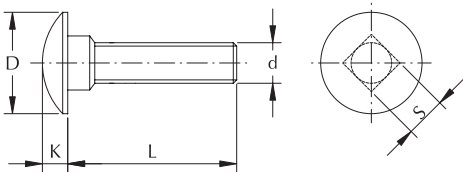

d	M5	M6	M7	M8	M10
D	13	16	18	20	24
K	3	3,5	4	4,5	5
S	5	6	7	8	10



- Tornillo carroceros de cabeza redonda y cuello cuadrado.
- Destinado a uniones de dos piezas, sean madera u otro material.
- Con tuerca hexagonal incluida.

CÓDIGO	(d)	L	ENVASE
02010500035B	M5	35	200
02010500050B	M5	50	200
02010600015B	M6	15	200
02010600120B	M6	120	100
02010700055B	M7	55	200

CÓDIGO	(d)	L	ENVASE
02010700090B	M7	90	100
02010800055B	M8	55	100
02011000060B	M10	60	100
02011000110B	M10	110	50
02011000120B	M10	120	100

0202 DIN 603 SIN TUERCA

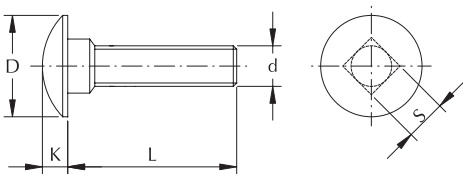

d	M5	M6	M7	M8	M10	1/4"
D	13	16	18	20	24	15
K	3	3,5	4	4,5	5	3,2
S	5	6	7	8	10	6,5



- Tornillo carroceros de cabeza redonda y cuello cuadrado.
- Destinado a uniones de dos piezas, sean madera u otro material.

CÓDIGO	(d)	L	ENVASE
02020500030B	M5	30	200
02020500035B	M5	35	200
02020500050B	M5	50	200
02020500065B	M5	65	200
02020600050B	M6	50	320
02020700030B	M7	30	200

CÓDIGO	(d)	L	ENVASE
02020800040B	M8	40	100
02020800085B	M8	85	800
02021000050B	M10	50	100
02021000070B	M10	70	100
02020140060B	1/4"	60	200
02020140090B	1/4"	90	100

Medidas en mm.

0203 DIN 603 SOMIER SIN TUERCA

d	M8
D	15
K	4
S	8
H	3,5

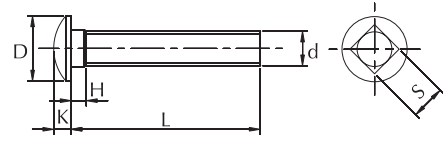

- Tornillo carrocer de cabeza redonda reducida y cuello cuadrado.
- Destinado a la fijación de patas de somier.



CÓDIGO	(d)	L	ENVASE
02030800045Z	M8	45	1000

0204 DIN 608 CALIDAD 6.8 CON TUERCA DIN 934

d	M10	M12
D	19	24
K	8	11
S	10	12
b	26	30

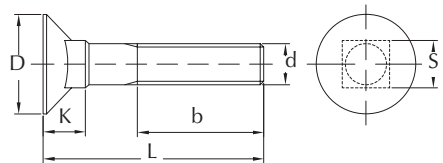

- Tornillo arado de cabeza plana y cuello cuadrado.
- Aplicaciones en arados "rejas" de todo tipo.
- Incluye tuerca hexagonal.



CÓDIGO	(d)	L	ENVASE
02041000040S	M10	40	100
02041000045P	M10	45	100
02041000050P	M10	50	100
02041200040P	M12	40	50
02041200050P	M12	50	50

CÓDIGO	(d)	L	ENVASE
02041200060S	M12	60	50
02041200070S	M12	70	50
02041200080P	M12	80	50
02041200090P	M12	90	50

Consultar disponibilidad en otras medidas.

0268 DIN 608 CALIDAD 8.8 CON TUERCA DIN 934

d	M10	M11 (7/16")	M12
D	19	22	24
K	8	10	11
S	10	11	12
b	26	28-36	30

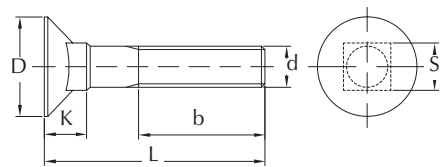

- Tornillo arado de cabeza plana y cuello cuadrado.
- Aplicaciones en arados "rejas" de todo tipo.
- Incluye tuerca hexagonal.
- Alta resistencia 8.8



CÓDIGO	(d)	L	ENVASE
02681000040Z	M10	40	100
02681000045Z	M10	45	100
02681000050Z	M10	50	100
02681100040Z	7/16" (M11)	40	100
02681100050Z	7/16" (M11)	50	100
02681100060Z	7/16" (M11)	60	100
02681100070Z	7/16" (M11)	70	100

CÓDIGO	(d)	L	ENVASE
02681200040Z	M12	40	50
02681200050Z	M12	50	50
02681200060Z	M12	60	50
02681200070Z	M12	70	50
02681200080Z	M12	80	50
02681200090Z	M12	90	50

Consultar disponibilidad en otras medidas.

Medidas en mm.

0205 DIN 933

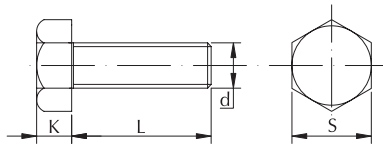

d	M3	M4	M5	M6	M7	M8	M10	M12
K	2	2,8	3,5	4	5	5,5	7	8
S	5,5	7	8	10	11	13	17	19

- Tornillo de cabeza hexagonal de baja resistencia.
- Todo roscado.

CÓDIGO	(d)	L	ENVASE
02050300008Z	M3	8	1000
02050300010Z	M3	10	1000
02050400008Z	M4	8	1000
02050400010Z	M4	10	500
02050400015Z	M4	15	500
02050400020Z	M4	20	500
02050400025Z	M4	25	500
02050400030Z	M4	30	1000
02050400035Z	M4	35	500
02050400040Z	M4	40	500
02050400045Z	M4	45	500
02050400050Z	M4	50	500
02050400060Z	M4	60	500
02050500008Z	M5	8	500
02050500010Z	M5	10	500
02050500012Z	M5	12	500
02050500015Z	M5	15	500
02050500016Z	M5	16	500
02050500020Z	M5	20	500
02050500025Z	M5	25	500
02050500030Z	M5	30	500
02050500035Z	M5	35	500
02050500040Z	M5	40	500
02050500045Z	M5	45	300
02050500050Z	M5	50	500
02050500055Z	M5	55	200
02050500060Z	M5	60	500
02050600008Z	M6	8	500
02050600010Z	M6	10	500
02050600012Z	M6	12	500
02050600016Z	M6	16	500
02050600020Z	M6	20	500
02050600025Z	M6	25	200
02050600030Z	M6	30	250
02050600035Z	M6	35	250
02050600040Z	M6	40	200
02050600045Z	M6	45	200
02050600050Z	M6	50	200
02050600055Z	M6	55	200
02050600060Z	M6	60	200
02050600065Z	M6	65	200
02050600070Z	M6	70	200
02050600080Z	M6	80	200
02050600090Z	M6	90	200
02050600100Z	M6	100	100
02050600110Z	M6	110	100
02050600120Z	M6	120	100

CÓDIGO	(d)	L	ENVASE
02050700045Z	M7	45	250
02050800010Z	M8	10	200
02050800012Z	M8	12	200
02050800016Z	M8	16	200
02050800020Z	M8	20	200
02050800025Z	M8	25	200
02050800030Z	M8	30	200
02050800035Z	M8	35	200
02050800040Z	M8	40	200
02050800045Z	M8	45	200
02050800050Z	M8	50	200
02050800055Z	M8	55	100
02050800060Z	M8	60	100
02050800070Z	M8	70	100
02050800080Z	M8	80	100
02050800090Z	M8	90	100
02050800100Z	M8	100	100
02050800120Z	M8	120	100
02050800130Z	M8	130	100
02050800140Z	M8	140	100
02050800150Z	M8	150	100
02051000016Z	M10	16	200
02051000020Z	M10	20	100
02051000025Z	M10	25	200
02051000030Z	M10	30	100
02051000035Z	M10	35	100
02051000040Z	M10	40	100
02051000045Z	M10	45	100
02051000050Z	M10	50	100
02051000055Z	M10	55	100
02051000060Z	M10	60	100
02051000065Z	M10	65	100
02051000070Z	M10	70	100
02051000080Z	M10	80	100
02051000090Z	M10	90	100
02051000100Z	M10	100	50
02051000120Z	M10	120	50
02051000130Z	M10	130	50
02051000140Z	M10	140	50
02051000150Z	M10	150	50
02051200020Z	M12	20	100
02051200025Z	M12	25	100
02051200030Z	M12	30	100
02051200035Z	M12	35	100
02051200040Z	M12	40	100
02051200045Z	M12	45	100
02051200050Z	M12	50	100

Medidas en mm.

d	M12	M14	M16
K	8	9	10
S	19	22	24

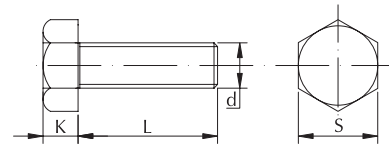

CÓDIGO	(d)	L	ENVASE
02051200060Z	M12	60	50
02051200070Z	M12	70	100
02051200080Z	M12	80	50
02051200090Z	M12	90	50
02051200100Z	M12	100	50
02051400040Z	M14	40	50
02051400045Z	M14	45	25
02051400050Z	M14	50	25
02051400060Z	M14	60	25
02051400070Z	M14	70	25
02051400080Z	M14	80	25
02051400090Z	M14	90	20

CÓDIGO	(d)	L	ENVASE
02051400100Z	M14	100	20
02051400120Z	M14	120	20
02051600030Z	M16	30	50
02051600035Z	M16	35	50
02051600040Z	M16	40	20
02051600045Z	M16	45	20
02051600050Z	M16	50	20
02051600060Z	M16	60	20
02051600070Z	M16	70	20
02051600080Z	M16	80	20
02051600090Z	M16	90	20
02051600100Z	M16	100	20

Consultar disponibilidad en otras medidas.

0206 DIN 933 CALIDAD 8.8

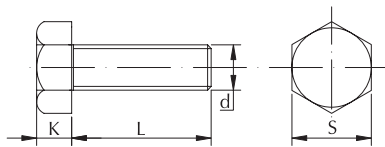

d	M3	M4	M5	M6	M7	M8
K	2	2,8	3,5	4	5	5,5
S	5,5	7	8	10	11	13



- Tornillo de cabeza hexagonal de alta resistencia 8.8.
- Todo roscado.

CÓDIGO	(d)	L	ENVASE
02060300006Z	M3	6	500
02060300008Z	M3	8	1000
02060300010Z	M3	10	1000
02060300012Z	M3	12	1000
02060300014Z	M3	14	500
02060300016Z	M3	16	500
02060300020Z	M3	20	500
02060300025Z	M3	25	1000
02060300030Z	M3	30	1000
02060300035Z	M3	35	1000
02060300040Z	M3	40	1000
02060400006Z	M4	6	1000
02060400007Z	M4	7	1000
02060400008Z	M4	8	500
02060400010Z	M4	10	500
02060400012Z	M4	12	1000
02060400014Z	M4	14	1000
02060400015Z	M4	15	500
02060400016Z	M4	16	500
02060400018Z	M4	18	500
02060400020Z	M4	20	500
02060400025Z	M4	25	500
02060400030Z	M4	30	1000
02060400035Z	M4	35	500
02060400040Z	M4	40	500
02060400045Z	M4	45	500
02060400050Z	M4	50	200
02060400055Z	M4	55	500
02060400060Z	M4	60	200
02060500008Z	M5	8	1000
02060500010Z	M5	10	500
02060500012Z	M5	12	500
02060500014Z	M5	14	500
02060500015Z	M5	15	500
02060500016Z	M5	16	500
02060500018Z	M5	18	500
02060500020Z	M5	20	500
02060500025Z	M5	25	500
02060500030Z	M5	30	500
02060500035Z	M5	35	500
02060500040Z	M5	40	500
02060500045Z	M5	45	500
02060500050Z	M5	50	200
02060500055Z	M5	55	200
02060500060Z	M5	60	400
02060500065Z	M5	65	500
02060500070Z	M5	70	200
02060500080Z	M5	80	200
02060500090Z	M5	90	200

CÓDIGO	(d)	L	ENVASE
02060600008Z	M6	8	500
02060600010Z	M6	10	500
02060600012Z	M6	12	500
02060600014Z	M6	14	500
02060600016Z	M6	16	200
02060600020Z	M6	20	200
02060600025Z	M6	25	200
02060600030Z	M6	30	200
02060600035Z	M6	35	200
02060600040Z	M6	40	200
02060600045Z	M6	45	200
02060600050Z	M6	50	200
02060600055Z	M6	55	200
02060600060Z	M6	60	200
02060600065Z	M6	65	200
02060600070Z	M6	70	200
02060600075Z	M6	75	200
02060600080Z	M6	80	200
02060600090Z	M6	90	200
02060600100Z	M6	100	200
02060600110Z	M6	110	100
02060600120Z	M6	120	100
02060700012Z	M7	12	200
02060700014Z	M7	14	200
02060700016Z	M7	16	200
02060700020Z	M7	20	200
02060700025Z	M7	25	200
02060700030Z	M7	30	200
02060700035Z	M7	35	200
02060700040Z	M7	40	200
02060700045Z	M7	45	200
02060700050Z	M7	50	200
02060700060Z	M7	60	200
02060700070Z	M7	70	200
02060700080Z	M7	80	200
02060800010Z	M8	10	250
02060800012Z	M8	12	200
02060800014Z	M8	14	200
02060800016Z	M8	16	200
02060800018Z	M8	18	200
02060800020Z	M8	20	200
02060800025Z	M8	25	200
02060800030Z	M8	30	200
02060800035Z	M8	35	200
02060800040Z	M8	40	200
02060800045Z	M8	45	200
02060800050Z	M8	50	200
02060800055Z	M8	55	100
02060800060Z	M8	60	100

Medidas en mm.

## 02 TORNILLOS ROSCA MÉTRICA

d	M8	M10	M12	M14	M16
K	5,5	7	8	9	10
S	13	17	19	22	24

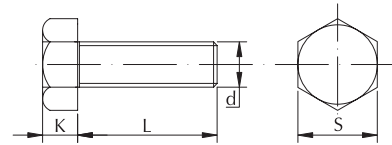

CÓDIGO	(d)	L	ENVASE
02060800065Z	M8	65	100
02060800070Z	M8	70	100
02060800075Z	M8	75	100
02060800080Z	M8	80	100
02060800090Z	M8	90	100
02060800100Z	M8	100	100
02060800105Z	M8	105	100
02060800110Z	M8	110	100
02060800120Z	M8	120	100
02060800125Z	M8	125	100
02060800130Z	M8	130	100
02060800140Z	M8	140	50
02060800150Z	M8	150	50
02060800160Z	M8	160	50
02060800170Z	M8	170	50
02060800180Z	M8	180	50
02060800190Z	M8	190	50
02060800200Z	M8	200	50
02061000010Z	M10	10	200
02061000012Z	M10	12	200
02061000014Z	M10	14	200
02061000015Z	M10	15	200
02061000016Z	M10	16	200
02061000020Z	M10	20	200
02061000025Z	M10	25	200
02061000030Z	M10	30	100
02061000035Z	M10	35	100
02061000040Z	M10	40	100
02061000045Z	M10	45	100
02061000050Z	M10	50	100
02061000055Z	M10	55	100
02061000060Z	M10	60	100
02061000065Z	M10	65	100
02061000070Z	M10	70	100
02061000075Z	M10	75	100
02061000080Z	M10	80	100
02061000090Z	M10	90	100
02061000100Z	M10	100	100
02061000110Z	M10	110	50
02061000120Z	M10	120	50
02061000130Z	M10	130	50
02061000140Z	M10	140	50
02061000150Z	M10	150	50
02061000160Z	M10	160	50
02061000170Z	M10	170	50
02061000180Z	M10	180	50
02061000190Z	M10	190	50
02061000200Z	M10	200	50
02061200016Z	M12	16	100
02061200020Z	M12	20	100
02061200025Z	M12	25	100
02061200030Z	M12	30	100
02061200035Z	M12	35	100
02061200040Z	M12	40	100
02061200045Z	M12	45	100
02061200050Z	M12	50	100

CÓDIGO	(d)	L	ENVASE
02061200055Z	M12	55	100
02061200060Z	M12	60	50
02061200065Z	M12	65	50
02061200070Z	M12	70	50
02061200075Z	M12	75	50
02061200080Z	M12	80	50
02061200090Z	M12	90	50
02061200100Z	M12	100	50
02061200110Z	M12	110	50
02061200120Z	M12	120	50
02061200130Z	M12	130	25
02061200140Z	M12	140	25
02061200150Z	M12	150	25
02061200160Z	M12	160	25
02061200170Z	M12	170	25
02061200180Z	M12	180	25
02061200190Z	M12	190	25
02061200200Z	M12	200	25
02061400016Z	M14	16	100
02061400020Z	M14	20	100
02061400025Z	M14	25	100
02061400030Z	M14	30	100
02061400035Z	M14	35	50
02061400040Z	M14	40	50
02061400045Z	M14	45	50
02061400050Z	M14	50	50
02061400055Z	M14	55	50
02061400060Z	M14	60	50
02061400065Z	M14	65	50
02061400070Z	M14	70	50
02061400075Z	M14	75	50
02061400080Z	M14	80	50
02061400090Z	M14	90	50
02061400100Z	M14	100	50
02061400110Z	M14	110	50
02061400120Z	M14	120	25
02061400130Z	M14	130	25
02061400140Z	M14	140	25
02061400150Z	M14	150	25
02061400160Z	M14	160	25
02061400170Z	M14	170	25
02061400180Z	M14	180	25
02061400190Z	M14	190	25
02061400200Z	M14	200	25
02061600020Z	M16	20	50
02061600025Z	M16	25	50
02061600030Z	M16	30	50
02061600035Z	M16	35	50
02061600040Z	M16	40	50
02061600045Z	M16	45	50
02061600050Z	M16	50	50
02061600055Z	M16	55	50
02061600060Z	M16	60	25
02061600065Z	M16	65	25
02061600070Z	M16	70	25
02061600075Z	M16	75	25

Medidas en mm.

0206 DIN 933 CALIDAD 8.8

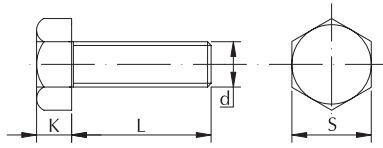

d	M16	M18	M20	M22	M24
K	10	11,5	12,5	14	15
S	24	27	30	32	36

CÓDIGO	(d)	L	ENVASE
02061600080Z	M16	80	25
02061600090Z	M16	90	25
02061600100Z	M16	100	25
02061600110Z	M16	110	25
02061600120Z	M16	120	25
02061600130Z	M16	130	25
02061600140Z	M16	140	25
02061600150Z	M16	150	25
02061600160Z	M16	160	25
02061600170Z	M16	170	25
02061600180Z	M16	180	25
02061600190Z	M16	190	25
02061600200Z	M16	200	25
02061800030Z	M18	30	50
02061800035Z	M18	35	50
02061800040Z	M18	40	50
02061800045Z	M18	45	50
02061800050Z	M18	50	50
02061800055Z	M18	55	25
02061800060Z	M18	60	25
02061800065Z	M18	65	25
02061800070Z	M18	70	25
02061800075Z	M18	75	25
02061800080Z	M18	80	25
02061800090Z	M18	90	25
02061800100Z	M18	100	25
02061800110Z	M18	110	25
02061800120Z	M18	120	25
02061800130Z	M18	130	25
02061800140Z	M18	140	25
02061800150Z	M18	150	25
02061800160Z	M18	160	25
02061800170Z	M18	170	25
02061800180Z	M18	180	25
02061800190Z	M18	190	25
02061800200Z	M18	200	25
02062000025Z	M20	25	25
02062000030Z	M20	30	25
02062000035Z	M20	35	25
02062000040Z	M20	40	25
02062000045Z	M20	45	25
02062000050Z	M20	50	25
02062000055Z	M20	55	25
02062000060Z	M20	60	25
02062000065Z	M20	65	25
02062000070Z	M20	70	25
02062000075Z	M20	75	25
02062000080Z	M20	80	25
02062000090Z	M20	90	25
02062000100Z	M20	100	25
02062000110Z	M20	110	25
02062000120Z	M20	120	10
02062000130Z	M20	130	25

CÓDIGO	(d)	L	ENVASE
02062000140Z	M20	140	25
02062000150Z	M20	150	10
02062000160Z	M20	160	10
02062000170Z	M20	170	10
02062000180Z	M20	180	10
02062000190Z	M20	190	10
02062000200Z	M20	200	10
02062200030Z	M22	30	25
02062200035Z	M22	35	25
02062200040Z	M22	40	25
02062200045Z	M22	45	25
02062200050Z	M22	50	25
02062200055Z	M22	55	25
02062200060Z	M22	60	25
02062200065Z	M22	65	25
02062200070Z	M22	70	25
02062200075Z	M22	75	25
02062200080Z	M22	80	25
02062200090Z	M22	90	25
02062200100Z	M22	100	10
02062200110Z	M22	110	10
02062200120Z	M22	120	10
02062200130Z	M22	130	10
02062200140Z	M22	140	10
02062200150Z	M22	150	10
02062200160Z	M22	160	10
02062200170Z	M22	170	10
02062200180Z	M22	180	10
02062200190Z	M22	190	10
02062200200Z	M22	200	10
02062400030Z	M24	30	25
02062400035Z	M24	35	25
02062400040Z	M24	40	25
02062400045Z	M24	45	25
02062400050Z	M24	50	25
02062400055Z	M24	55	25
02062400060Z	M24	60	25
02062400065Z	M24	65	25
02062400070Z	M24	70	25
02062400075Z	M24	75	25
02062400080Z	M24	80	10
02062400090Z	M24	90	10
02062400100Z	M24	100	10
02062400110Z	M24	110	10
02062400120Z	M24	120	10
02062400130Z	M24	130	10
02062400140Z	M24	140	10
02062400150Z	M24	150	10
02062400160Z	M24	160	10
02062400170Z	M24	170	10
02062400180Z	M24	180	10
02062400190Z	M24	190	10
02062400200Z	M24	200	10

Consultar disponibilidad en otras medidas.

Medidas en mm.



0206 DIN 933 CALIDAD 8.8

d	M3	M4	M5	M6	M8
K	2	2,8	3,5	4	5,5
S	5,5	7	8	10	13

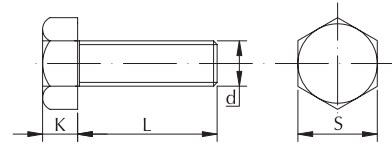

- Tornillo de cabeza hexagonal de alta resistencia 8.8.
- Todo roscado.



CÓDIGO	(d)	L	ENVASE
02060300006P	M3	6	1000
02060300008P	M3	8	1000
02060300010P	M3	10	1000
02060300012P	M3	12	1000
02060300014P	M3	14	500
02060300016P	M3	16	500
02060300020P	M3	20	500
02060300025P	M3	25	1000
02060300030P	M3	30	1000
02060300035P	M3	35	1000
02060300040P	M3	40	1000
02060400006P	M4	6	1000
02060400008P	M4	8	1000
02060400010P	M4	10	1000
02060400012P	M4	12	1000
02060400014P	M4	14	1000
02060400016P	M4	16	500
02060400020P	M4	20	500
02060400025P	M4	25	500
02060400030P	M4	30	500
02060400035P	M4	35	500
02060400040P	M4	40	500
02060400045P	M4	45	500
02060400050P	M4	50	500
02060400060P	M4	60	500
02060500008P	M5	8	500
02060500010P	M5	10	500
02060500012P	M5	12	500
02060500014P	M5	14	500
02060500016P	M5	16	500
02060500020P	M5	20	500
02060500025P	M5	25	500
02060500030P	M5	30	500
02060500035P	M5	35	200
02060500040P	M5	40	200
02060500045P	M5	45	200
02060500050P	M5	50	200
02060500055P	M5	55	500
02060500060P	M5	60	200
02060500065P	M5	65	200
02060500070P	M5	70	200
02060500080P	M5	80	200
02060500090P	M5	90	200
02060500100P	M5	100	200
02060600008P	M6	8	500
02060600010P	M6	10	500
02060600012P	M6	12	500

CÓDIGO	(d)	L	ENVASE
02060600014P	M6	14	500
02060600016P	M6	16	500
02060600020P	M6	20	500
02060600025P	M6	25	500
02060600030P	M6	30	200
02060600035P	M6	35	200
02060600040P	M6	40	200
02060600045P	M6	45	200
02060600050P	M6	50	200
02060600055P	M6	55	200
02060600060P	M6	60	200
02060600065P	M6	65	200
02060600070P	M6	70	200
02060600075P	M6	75	200
02060600080P	M6	80	200
02060600090P	M6	90	100
02060600100P	M6	100	100
02060600110P	M6	110	100
02060600120P	M6	120	100
02060600130P	M6	130	100
02060600140P	M6	140	100
02060800010P	M8	10	200
02060800012P	M8	12	200
02060800014P	M8	14	200
02060800016P	M8	16	200
02060800020P	M8	20	200
02060800025P	M8	25	200
02060800030P	M8	30	200
02060800035P	M8	35	200
02060800040P	M8	40	200
02060800045P	M8	45	200
02060800050P	M8	50	200
02060800055P	M8	55	200
02060800060P	M8	60	200
02060800065P	M8	65	200
02060800070P	M8	70	100
02060800075P	M8	75	100
02060800080P	M8	80	100
02060800090P	M8	90	100
02060800100P	M8	100	100
02060800110P	M8	110	100
02060800120P	M8	120	100
02060800130P	M8	130	100
02060800140P	M8	140	50
02060800150P	M8	150	50
02060800160P	M8	160	50
02060800170P	M8	170	50

Medidas en mm.

0206 DIN 933 CALIDAD 8.8

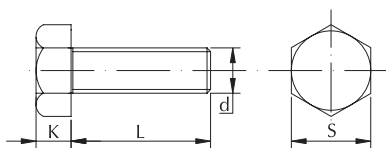

d	M8	M10	M12	M14	M16
K	5,5	7	8	9	10
S	13	17	19	22	24

CÓDIGO	(d)	L	ENVASE
02060800180P	M8	180	50
02060800190P	M8	190	50
02060800200P	M8	200	50
02061000012P	M10	12	200
02061000014P	M10	14	200
02061000016P	M10	16	200
02061000020P	M10	20	200
02061000025P	M10	25	200
02061000030P	M10	30	200
02061000035P	M10	35	100
02061000040P	M10	40	100
02061000045P	M10	45	100
02061000050P	M10	50	100
02061000055P	M10	55	100
02061000060P	M10	60	100
02061000065P	M10	65	100
02061000070P	M10	70	100
02061000075P	M10	75	100
02061000080P	M10	80	100
02061000085P	M10	85	100
02061000090P	M10	90	100
02061000095P	M10	95	100
02061000100P	M10	100	50
02061000110P	M10	110	50
02061000120P	M10	120	50
02061000130P	M10	130	50
02061000140P	M10	140	50
02061000150P	M10	150	50
02061000160P	M10	160	50
02061000170P	M10	170	50
02061000180P	M10	180	50
02061000190P	M10	190	50
02061000200P	M10	200	50
02061200016P	M12	16	100
02061200020P	M12	20	100
02061200025P	M12	25	100
02061200030P	M12	30	100
02061200035P	M12	35	100
02061200040P	M12	40	100
02061200045P	M12	45	100
02061200050P	M12	50	100
02061200055P	M12	55	100
02061200060P	M12	60	100
02061200065P	M12	65	50
02061200070P	M12	70	50
02061200075P	M12	75	50
02061200080P	M12	80	50
02061200085P	M12	85	50
02061200090P	M12	90	50
02061200095P	M12	95	50

CÓDIGO	(d)	L	ENVASE
02061200100P	M12	100	50
02061200110P	M12	110	50
02061200120P	M12	120	25
02061200130P	M12	130	25
02061200140P	M12	140	25
02061200150P	M12	150	25
02061200160P	M12	160	25
02061200170P	M12	170	25
02061200180P	M12	180	25
02061200190P	M12	190	25
02061200200P	M12	200	25
02061400020P	M14	20	100
02061400025P	M14	25	100
02061400030P	M14	30	100
02061400035P	M14	35	100
02061400040P	M14	40	100
02061400045P	M14	45	50
02061400050P	M14	50	50
02061400055P	M14	55	50
02061400060P	M14	60	50
02061400065P	M14	65	50
02061400070P	M14	70	50
02061400075P	M14	75	50
02061400080P	M14	80	50
02061400090P	M14	90	50
02061400100P	M14	100	50
02061400110P	M14	110	50
02061400120P	M14	120	25
02061400130P	M14	130	25
02061400140P	M14	140	25
02061400150P	M14	150	25
02061400160P	M14	160	25
02061400170P	M14	170	25
02061400180P	M14	180	25
02061400190P	M14	190	25
02061400200P	M14	200	25
02061600025P	M16	25	50
02061600030P	M16	30	50
02061600035P	M16	35	50
02061600040P	M16	40	50
02061600045P	M16	45	50
02061600050P	M16	50	50
02061600055P	M16	55	25
02061600060P	M16	60	25
02061600065P	M16	65	25
02061600070P	M16	70	25
02061600075P	M16	75	25
02061600080P	M16	80	25
02061600090P	M16	90	25
02061600100P	M16	100	25

Medidas en mm.

d	M16	M18	M20	M22	M24
K	10	11,5	12,5	14	15
S	24	27	30	32	36

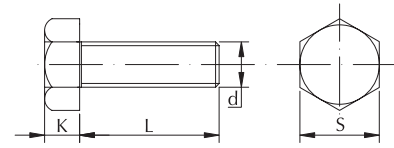

CÓDIGO	(d)	L	ENVASE
02061600110P	M16	110	25
02061600120P	M16	120	25
02061600130P	M16	130	25
02061600140P	M16	140	25
02061600150P	M16	150	25
02061600160P	M16	160	25
02061600170P	M16	170	25
02061600180P	M16	180	25
02061600190P	M16	190	25
02061600200P	M16	200	25
02061800030P	M18	30	50
02061800035P	M18	35	50
02061800040P	M18	40	50
02061800045P	M18	45	50
02061800050P	M18	50	50
02061800055P	M18	55	25
02061800060P	M18	60	25
02061800065P	M18	65	25
02061800070P	M18	70	25
02061800075P	M18	75	25
02061800080P	M18	80	25
02061800090P	M18	90	25
02061800100P	M18	100	25
02061800110P	M18	110	25
02061800120P	M18	120	25
02061800130P	M18	130	25
02061800140P	M18	140	25
02061800150P	M18	150	25
02061800160P	M18	160	25
02061800170P	M18	170	25
02061800180P	M18	180	25
02061800190P	M18	190	25
02061800200P	M18	200	25
02062000030P	M20	30	25
02062000035P	M20	35	25
02062000040P	M20	40	25
02062000045P	M20	45	25
02062000050P	M20	50	25
02062000055P	M20	55	25
02062000060P	M20	60	25
02062000065P	M20	65	25
02062000070P	M20	70	25
02062000075P	M20	75	25
02062000080P	M20	80	25
02062000090P	M20	90	25
02062000100P	M20	100	25
02062000110P	M20	110	25
02062000120P	M20	120	25
02062000130P	M20	130	25

CÓDIGO	(d)	L	ENVASE
02062000140P	M20	140	25
02062000150P	M20	150	10
02062000160P	M20	160	10
02062000170P	M20	170	10
02062000180P	M20	180	10
02062000190P	M20	190	10
02062000200P	M20	200	10
02062200030P	M22	30	25
02062200040P	M22	40	25
02062200045P	M22	45	25
02062200050P	M22	50	25
02062200055P	M22	55	25
02062200060P	M22	60	25
02062200065P	M22	65	25
02062200070P	M22	70	25
02062200080P	M22	80	25
02062200090P	M22	90	25
02062200100P	M22	100	10
02062200110P	M22	110	10
02062200120P	M22	120	10
02062200130P	M22	130	10
02062200140P	M22	140	10
02062200150P	M22	150	10
02062200160P	M22	160	10
02062200170P	M22	170	10
02062200180P	M22	180	10
02062200190P	M22	190	10
02062200200P	M22	200	10
02062400040P	M24	40	25
02062400045P	M24	45	25
02062400050P	M24	50	25
02062400055P	M24	55	25
02062400060P	M24	60	25
02062400065P	M24	65	25
02062400070P	M24	70	25
02062400075P	M24	75	25
02062400080P	M24	80	10
02062400090P	M24	90	10
02062400100P	M24	100	10
02062400110P	M24	110	10
02062400120P	M24	120	10
02062400130P	M24	130	10
02062400140P	M24	140	10
02062400150P	M24	150	10
02062400160P	M24	160	10
02062400170P	M24	170	10
02062400180P	M24	180	10
02062400190P	M24	190	10
02062400200P	M24	200	10

Consultar disponibilidad en otras medidas.

Medidas en mm.

0273 DIN 933 CALIDAD 10.9

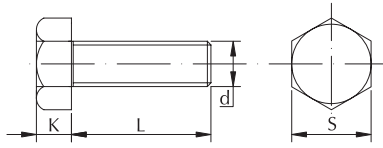

d	M8	M10	M12	M14	M16	M18	M20
K	5,5	7	8	9	10	9	9
S	13	17	19	22	24	22	22



- Tornillo de cabeza hexagonal de alta resistencia 10.9.
- Todo roscado.

CÓDIGO	(d)	L	ENVASE
02730800012Z	M8	12	200
02730800016Z	M8	16	200
02730800020Z	M8	20	200
02730800025Z	M8	25	200
02730800030Z	M8	30	200
02730800035Z	M8	35	200
02730800040Z	M8	40	200
02730800045Z	M8	45	200
02730800050Z	M8	50	200
02730800055Z	M8	55	200
02730800060Z	M8	60	200
02730800070Z	M8	70	100
02730800080Z	M8	80	100
02730800100Z	M8	100	100
02731000016Z	M10	16	200
02731000020Z	M10	20	200
02731000025Z	M10	25	200
02731000030Z	M10	30	100
02731000035Z	M10	35	100
02731000040Z	M10	40	100
02731000045Z	M10	45	100
02731000050Z	M10	50	100
02731000055Z	M10	55	100
02731000060Z	M10	60	100
02731000070Z	M10	70	50
02731000080Z	M10	80	50
02731000090Z	M10	90	50
02731000100Z	M10	100	50
02731200020Z	M12	20	100
02731200025Z	M12	25	100
02731200030Z	M12	30	100
02731200035Z	M12	35	100
02731200040Z	M12	40	100
02731200045Z	M12	45	100
02731200050Z	M12	50	100
02731200055Z	M12	55	100
02731200060Z	M12	60	50
02731200065Z	M12	65	50
02731200070Z	M12	70	50
02731200080Z	M12	80	50
02731200085Z	M12	85	50
02731200090Z	M12	90	50
02731200100Z	M12	100	50
02731400025Z	M14	25	100
02731400030Z	M14	30	100
02731400035Z	M14	35	100

CÓDIGO	(d)	L	ENVASE
02731400040Z	M14	40	100
02731400045Z	M14	45	50
02731400050Z	M14	50	50
02731400055Z	M14	55	50
02731400060Z	M14	60	50
02731400070Z	M14	70	50
02731400080Z	M14	80	50
02731400090Z	M14	90	25
02731400100Z	M14	100	25
02731600025Z	M16	25	50
02731600030Z	M16	30	50
02731600035Z	M16	35	50
02731600040Z	M16	40	50
02731600045Z	M16	45	50
02731600050Z	M16	50	25
02731600055Z	M16	55	25
02731600060Z	M16	60	25
02731600065Z	M16	65	25
02731600070Z	M16	70	25
02731600075Z	M16	75	25
02731600080Z	M16	80	25
02731600085Z	M16	85	25
02731600090Z	M16	90	25
02731600100Z	M16	100	25
02731600110Z	M16	110	25
02731600120Z	M16	120	25
02731600140Z	M16	140	25
02731600160Z	M16	160	25
02731800040Z	M18	40	50
02731800045Z	M18	45	50
02731800050Z	M18	50	50
02731800060Z	M18	60	25
02731800065Z	M18	65	25
02731800070Z	M18	70	25
02731800080Z	M18	80	25
02731800090Z	M18	90	25
02731800100Z	M18	100	25
02732000030Z	M20	30	25
02732000040Z	M20	40	25
02732000045Z	M20	45	25
02732000050Z	M20	50	25
02732000055Z	M20	55	25
02732000060Z	M20	60	25
02732000065Z	M20	65	25
02732000070Z	M20	70	25
02732000075Z	M20	75	25

Medidas en mm.

d	M20	M22	M24
K	12,5	14	15
S	30	32	36

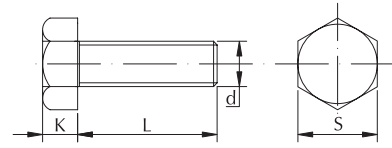

CÓDIGO	(d)	L	ENVASE
02732000080Z	M20	80	25
02732000090Z	M20	90	25
02732000100Z	M20	100	25
02732000110Z	M20	110	25
02732000120Z	M20	120	25
02732000130Z	M20	130	10
02732200050Z	M22	50	25
02732200060Z	M22	60	25
02732200070Z	M22	70	25
02732200080Z	M22	80	25
02732200090Z	M22	90	25
02732200100Z	M22	100	10
02732200120Z	M22	120	10

CÓDIGO	(d)	L	ENVASE
02732400045Z	M24	45	25
02732400050Z	M24	50	25
02732400055Z	M24	55	25
02732400060Z	M24	60	25
02732400065Z	M24	65	25
02732400070Z	M24	70	25
02732400080Z	M24	80	25
02732400090Z	M24	90	25
02732400100Z	M24	100	10
02732400110Z	M24	110	10
02732400120Z	M24	120	10
02732400200Z	M24	200	5

Consultar disponibilidad en otras medidas.

0273 DIN 933 CALIDAD 10.9

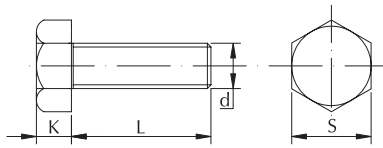

d	M8	M10	M12	M14	M16	M18
K	5,5	7	8	9	10	11,5
S	13	17	19	22	24	27



- Tornillo de cabeza hexagonal de alta resistencia 10.9.
- Todo roscado.

CÓDIGO	(d)	L	ENVASE
02730800010P	M8	10	200
02730800012P	M8	12	200
02730800014P	M8	14	200
02730800016P	M8	16	200
02730800020P	M8	20	200
02730800025P	M8	25	200
02730800030P	M8	30	200
02730800035P	M8	35	200
02730800040P	M8	40	200
02730800045P	M8	45	200
02730800050P	M8	50	200
02730800055P	M8	55	200
02730800060P	M8	60	200
02730800065P	M8	65	200
02730800070P	M8	70	100
02730800080P	M8	80	100
02730800090P	M8	90	100
02730800100P	M8	100	100
02730800120P	M8	120	50
02731000016P	M10	16	200
02731000020P	M10	20	200
02731000025P	M10	25	200
02731000030P	M10	30	100
02731000035P	M10	35	100
02731000040P	M10	40	100
02731000045P	M10	45	100
02731000050P	M10	50	100
02731000055P	M10	55	100
02731000060P	M10	60	100
02731000070P	M10	70	50
02731000075P	M10	75	50
02731000080P	M10	80	50
02731000090P	M10	90	50
02731000100P	M10	100	50
02731000120P	M10	120	50
02731000150P	M10	150	50
02731200016P	M12	16	100
02731200020P	M12	20	100
02731200025P	M12	25	100
02731200030P	M12	30	100
02731200035P	M12	35	100
02731200040P	M12	40	100
02731200045P	M12	45	100
02731200050P	M12	50	100
02731200055P	M12	55	100
02731200060P	M12	60	50

CÓDIGO	(d)	L	ENVASE
02731200070P	M12	70	50
02731200075P	M12	75	50
02731200080P	M12	80	50
02731200085P	M12	85	50
02731200090P	M12	90	50
02731200100P	M12	100	50
02731200130P	M12	130	25
02731400025P	M14	25	100
02731400030P	M14	30	100
02731400035P	M14	35	100
02731400040P	M14	40	100
02731400045P	M14	45	50
02731400050P	M14	50	50
02731400055P	M14	55	50
02731400060P	M14	60	50
02731400070P	M14	70	50
02731400080P	M14	80	50
02731400090P	M14	90	25
02731400100P	M14	100	25
02731400150P	M14	150	25
02731600025P	M16	25	50
02731600030P	M16	30	50
02731600035P	M16	35	50
02731600040P	M16	40	50
02731600045P	M16	45	50
02731600050P	M16	50	25
02731600055P	M16	55	25
02731600060P	M16	60	25
02731600065P	M16	65	25
02731600070P	M16	70	25
02731600075P	M16	75	25
02731600080P	M16	80	25
02731600090P	M16	90	25
02731600100P	M16	100	25
02731600110P	M16	110	25
02731600120P	M16	120	25
02731600140P	M16	140	25
02731600160P	M16	160	25
02731800030P	M18	30	50
02731800035P	M18	35	50
02731800040P	M18	40	50
02731800045P	M18	45	50
02731800050P	M18	50	50
02731800055P	M18	55	25
02731800060P	M18	60	25
02731800070P	M18	70	25

Medidas en mm.

d	M18	M20	M22	M24
K	11,5	12,5	14	15
S	27	30	32	36

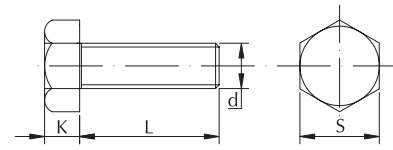

CÓDIGO	(d)	L	ENVASE
02731800080P	M18	80	25
02731800090P	M18	90	25
02731800100P	M18	100	25
02731800120P	M18	120	25
02731800130P	M18	130	25
02731800200P	M18	200	10
02732000030P	M20	30	25
02732000040P	M20	40	25
02732000045P	M20	45	25
02732000050P	M20	50	25
02732000055P	M20	55	25
02732000060P	M20	60	25
02732000065P	M20	65	25
02732000070P	M20	70	25
02732000075P	M20	75	25
02732000080P	M20	80	25
02732000090P	M20	90	25
02732000100P	M20	100	25
02732000110P	M20	110	25
02732000120P	M20	120	25
02732000130P	M20	130	10
02732000140P	M20	140	10
02732000150P	M20	150	10
02732000160P	M20	160	10
02732200040P	M22	40	25
02732200045P	M22	45	25

CÓDIGO	(d)	L	ENVASE
02732200050P	M22	50	25
02732200060P	M22	60	25
02732200070P	M22	70	25
02732200080P	M22	80	25
02732200090P	M22	90	25
02732200100P	M22	100	10
02732200110P	M22	110	10
02732200120P	M22	120	10
02732200200P	M22	200	10
02732400045P	M24	45	25
02732400050P	M24	50	25
02732400055P	M24	55	25
02732400060P	M24	60	25
02732400065P	M24	65	25
02732400070P	M24	70	25
02732400075P	M24	75	25
02732400080P	M24	80	25
02732400090P	M24	90	25
02732400100P	M24	100	10
02732400110P	M24	110	10
02732400120P	M24	120	10
02732400130P	M24	130	10
02732400140P	M24	140	10
02732400150P	M24	150	10
02732400200P	M24	200	5

Consultar disponibilidad en otras medidas.

0207 DIN 931 CALIDAD 8.8

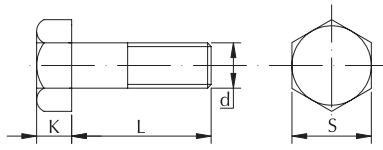

d	M4	M5	M6	M8	M10	M12	M14	M16	M18	M20	M24
K	2,8	3,5	4	5,5	7	8	8	10	11,5	12,5	15
S	7	8	10	13	17	19	19	24	27	30	36

- Tornillo de cabeza hexagonal de alta resistencia 8.8.
- Rosca parcial.

CÓDIGO	(d)	L	ENVASE
02070400020Z	M4	20	500
02070400025Z	M4	25	500
02070400030Z	M4	30	500
02070400035Z	M4	35	500
02070400040Z	M4	40	500
02070400045Z	M4	45	500
02070400050Z	M4	50	500
02070400055Z	M4	55	500
02070400060Z	M4	60	500
02070500020Z	M5	20	500
02070500025Z	M5	25	500
02070500030Z	M5	30	500
02070500035Z	M5	35	500
02070500040Z	M5	40	200
02070500045Z	M5	45	200
02070500050Z	M5	50	200
02070500055Z	M5	55	200
02070500060Z	M5	60	200
02070500070Z	M5	70	200
02070600025Z	M6	25	500
02070600030Z	M6	30	500
02070600035Z	M6	35	500
02070600040Z	M6	40	200
02070600045Z	M6	45	200
02070600050Z	M6	50	200
02070600055Z	M6	55	200
02070600060Z	M6	60	200
02070600065Z	M6	65	200
02070600070Z	M6	70	200
02070600080Z	M6	80	200
02070600090Z	M6	90	100
02070600100Z	M6	100	100
02070600110Z	M6	110	100
02070600120Z	M6	120	100
02070800035Z	M8	35	200
02070800040Z	M8	40	200
02070800045Z	M8	45	200
02070800050Z	M8	50	200
02070800055Z	M8	55	200
02070800060Z	M8	60	200
02070800065Z	M8	65	200
02070800070Z	M8	70	100
02070800080Z	M8	80	100
02070800090Z	M8	90	100
02070800100Z	M8	100	100
02070800110Z	M8	110	100
02070800120Z	M8	120	100
02070800130Z	M8	130	100
02070800140Z	M8	140	50
02070800150Z	M8	150	50

CÓDIGO	(d)	L	ENVASE
02070800170Z	M8	170	50
02070800200Z	M8	200	50
02071000035Z	M10	35	100
02071000040Z	M10	40	100
02071000045Z	M10	45	100
02071000050Z	M10	50	100
02071000055Z	M10	55	100
02071000060Z	M10	60	100
02071000065Z	M10	65	100
02071000070Z	M10	70	100
02071000080Z	M10	80	100
02071000090Z	M10	90	50
02071000100Z	M10	100	50
02071000110Z	M10	110	50
02071000120Z	M10	120	50
02071000125Z	M10	125	50
02071000130Z	M10	130	50
02071000140Z	M10	140	50
02071000150Z	M10	150	50
02071000160Z	M10	160	50
02071000180Z	M10	180	50
02071000200Z	M10	200	50
02071200035Z	M12	35	100
02071200040Z	M12	40	100
02071200045Z	M12	45	100
02071200050Z	M12	50	100
02071200055Z	M12	55	100
02071200060Z	M12	60	100
02071200065Z	M12	65	50
02071200070Z	M12	70	50
02071200075Z	M12	75	50
02071200080Z	M12	80	50
02071200090Z	M12	90	50
02071200100Z	M12	100	50
02071200110Z	M12	110	50
02071200120Z	M12	120	25
02071200130Z	M12	130	25
02071200140Z	M12	140	25
02071200150Z	M12	150	25
02071200160Z	M12	160	25
02071200180Z	M12	180	25
02071200200Z	M12	200	25
02071200210Z	M12	210	25
02071200220Z	M12	220	25
02071200230Z	M12	230	25
02071200240Z	M12	240	25
02071200250Z	M12	250	25
02071400040Z	M14	40	100
02071400045Z	M14	45	50
02071400050Z	M14	50	50

Medidas en mm.



CÓDIGO	(d)	L	ENVASE
02071400055Z	M14	55	50
02071400060Z	M14	60	50
02071400065Z	M14	65	50
02071400070Z	M14	70	50
02071400080Z	M14	80	50
02071400090Z	M14	90	50
02071400100Z	M14	100	50
02071400110Z	M14	110	25
02071400120Z	M14	120	25
02071400130Z	M14	130	25
02071400140Z	M14	140	25
02071400150Z	M14	150	25
02071400160Z	M14	160	25
02071400170Z	M14	170	25
02071400180Z	M14	180	25
02071400190Z	M14	190	25
02071400200Z	M14	200	25
02071400210Z	M14	210	25
02071400220Z	M14	220	25
02071400230Z	M14	230	25
02071400240Z	M14	240	25
02071400250Z	M14	250	25
02071600045Z	M16	45	50
02071600050Z	M16	50	50
02071600055Z	M16	55	50
02071600060Z	M16	60	50
02071600065Z	M16	65	25
02071600070Z	M16	70	25
02071600075Z	M16	75	25
02071600080Z	M16	80	25
02071600090Z	M16	90	25
02071600100Z	M16	100	25
02071600110Z	M16	110	25
02071600120Z	M16	120	25
02071600130Z	M16	130	25
02071600140Z	M16	140	25
02071600150Z	M16	150	25
02071600160Z	M16	160	25
02071600170Z	M16	170	25
02071600180Z	M16	180	25
02071600190Z	M16	190	25
02071600200Z	M16	200	25
02071600210Z	M16	210	25
02071600220Z	M16	220	25
02071600230Z	M16	230	25
02071600240Z	M16	240	25
02071600250Z	M16	250	25
02071800050Z	M18	50	25
02071800060Z	M18	60	25
02071800070Z	M18	70	25
02071800080Z	M18	80	25
02071800090Z	M18	90	25
02071800100Z	M18	100	25
02071800110Z	M18	110	25
02071800120Z	M18	120	25
02071800130Z	M18	130	25
02071800140Z	M18	140	25

CÓDIGO	(d)	L	ENVASE
02071800150Z	M18	150	25
02071800160Z	M18	160	25
02071800170Z	M18	170	25
02071800180Z	M18	180	25
02071800190Z	M18	190	25
02071800200Z	M18	200	25
02071800210Z	M18	210	25
02071800220Z	M18	220	25
02071800230Z	M18	230	25
02071800240Z	M18	240	25
02071800250Z	M18	250	25
02072000050Z	M20	50	25
02072000055Z	M20	55	25
02072000060Z	M20	60	25
02072000070Z	M20	70	25
02072000080Z	M20	80	25
02072000090Z	M20	90	25
02072000100Z	M20	100	25
02072000110Z	M20	110	25
02072000120Z	M20	120	25
02072000130Z	M20	130	25
02072000140Z	M20	140	25
02072000150Z	M20	150	10
02072000160Z	M20	160	10
02072000170Z	M20	170	10
02072000180Z	M20	180	10
02072000190Z	M20	190	10
02072000200Z	M20	200	10
02072000210Z	M20	210	10
02072000220Z	M20	220	10
02072000230Z	M20	230	10
02072000240Z	M20	240	10
02072000250Z	M20	250	10
02072000260Z	M20	260	10
02072000270Z	M20	270	10
02072000280Z	M20	280	10
02072000290Z	M20	290	10
02072000300Z	M20	300	10
02072200060Z	M22	60	25
02072200070Z	M22	70	25
02072200080Z	M22	80	25
02072200090Z	M22	90	25
02072200100Z	M22	100	25
02072200110Z	M22	110	25
02072200130Z	M22	130	25
02072200150Z	M22	150	25
02072200160Z	M22	160	25
02072400080Z	M24	80	25
02072400090Z	M24	90	25
02072400100Z	M24	100	25
02072400110Z	M24	110	25
02072400130Z	M24	130	25
02072400140Z	M24	140	25
02072400150Z	M24	150	25
02072400160Z	M24	160	25
02072400180Z	M24	180	25

Consultar disponibilidad en otras medidas.

Medidas en mm.

0207 DIN 931 CALIDAD 8.8

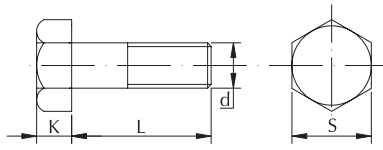

d	M4	M5	M6	M7	M8	M10	M12
K	2,8	3,5	4	5	5,5	7	8
S	7	8	10	11	13	17	19



- Tornillo de cabeza hexagonal de alta resistencia 8.8.
- Rosca parcial.

CÓDIGO	(d)	L	ENVASE
02070400020P	M4	20	500
02070400025P	M4	25	500
02070400030P	M4	30	500
02070400035P	M4	35	500
02070400040P	M4	40	500
02070400045P	M4	45	500
02070400050P	M4	50	500
02070400055P	M4	55	500
02070400060P	M4	60	500
02070500020P	M5	20	500
02070500025P	M5	25	500
02070500030P	M5	30	500
02070500035P	M5	35	500
02070500040P	M5	40	200
02070500045P	M5	45	200
02070500050P	M5	50	200
02070500055P	M5	55	200
02070500060P	M5	60	200
02070500070P	M5	70	200
02070600025P	M6	25	500
02070600030P	M6	30	500
02070600035P	M6	35	500
02070600040P	M6	40	200
02070600045P	M6	45	200
02070600050P	M6	50	200
02070600055P	M6	55	200
02070600060P	M6	60	200
02070600065P	M6	65	200
02070600070P	M6	70	200
02070600080P	M6	80	200
02070600090P	M6	90	100
02070600100P	M6	100	100
02070600110P	M6	110	100
02070600120P	M6	120	100
02070700045P	M7	45	200
02070700050P	M7	50	200
02070700055P	M7	55	200
02070700060P	M7	60	200
02070700070P	M7	70	100
02070800035P	M8	35	200
02070800040P	M8	40	200
02070800045P	M8	45	200
02070800050P	M8	50	200
02070800055P	M8	55	200
02070800060P	M8	60	200
02070800065P	M8	65	200
02070800070P	M8	70	100
02070800080P	M8	80	100
02070800090P	M8	90	100
02070800100P	M8	100	100

CÓDIGO	(d)	L	ENVASE
02070800110P	M8	110	100
02070800120P	M8	120	100
02070800130P	M8	130	100
02070800140P	M8	140	50
02070800150P	M8	150	50
02070800160P	M8	160	50
02070800170P	M8	170	50
02071000030P	M10	30	200
02071000035P	M10	35	100
02071000040P	M10	40	100
02071000045P	M10	45	100
02071000050P	M10	50	100
02071000055P	M10	55	100
02071000060P	M10	60	100
02071000065P	M10	65	100
02071000070P	M10	70	100
02071000080P	M10	80	100
02071000090P	M10	90	50
02071000100P	M10	100	50
02071000110P	M10	110	50
02071000120P	M10	120	50
02071000130P	M10	130	50
02071000140P	M10	140	50
02071000150P	M10	150	50
02071000160P	M10	160	50
02071000180P	M10	180	50
02071000200P	M10	200	50
02071200035P	M12	35	100
02071200040P	M12	40	100
02071200045P	M12	45	100
02071200050P	M12	50	100
02071200055P	M12	55	100
02071200060P	M12	60	100
02071200065P	M12	65	50
02071200070P	M12	70	50
02071200075P	M12	75	50
02071200080P	M12	80	50
02071200090P	M12	90	50
02071200100P	M12	100	50
02071200110P	M12	110	50
02071200120P	M12	120	25
02071200130P	M12	130	25
02071200140P	M12	140	25
02071200150P	M12	150	25
02071200160P	M12	160	25
02071200170P	M12	170	25
02071200180P	M12	180	25
02071200200P	M12	200	25
02071200210P	M12	210	25
02071200220P	M12	220	25

Medidas en mm.

d	M12	M14	M16	M18	M20	M22
K	8	9	10	11,5	12,5	14
S	19	22	24	27	30	32

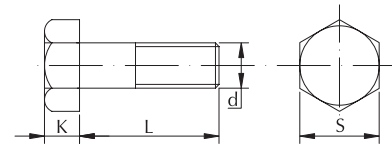

CÓDIGO	(d)	L	ENVASE
02071200230P	M12	230	25
02071200240P	M12	240	25
02071200250P	M12	250	25
02071400040P	M14	40	100
02071400045P	M14	45	50
02071400050P	M14	50	50
02071400055P	M14	55	50
02071400060P	M14	60	50
02071400065P	M14	65	50
02071400070P	M14	70	50
02071400080P	M14	80	50
02071400090P	M14	90	50
02071400100P	M14	100	50
02071400110P	M14	110	25
02071400120P	M14	120	25
02071400130P	M14	130	25
02071400140P	M14	140	25
02071400150P	M14	150	25
02071400160P	M14	160	25
02071400170P	M14	170	25
02071400180P	M14	180	25
02071400190P	M14	190	25
02071400200P	M14	200	25
02071400210P	M14	210	25
02071400220P	M14	220	25
02071400230P	M14	230	25
02071400240P	M14	240	25
02071400250P	M14	250	25
02071600050P	M16	50	50
02071600055P	M16	55	50
02071600060P	M16	60	50
02071600070P	M16	70	25
02071600080P	M16	80	25
02071600090P	M16	90	25
02071600100P	M16	100	25
02071600110P	M16	110	25
02071600120P	M16	120	25
02071600130P	M16	130	25
02071600140P	M16	140	25
02071600150P	M16	150	25
02071600160P	M16	160	25
02071600170P	M16	170	25
02071600180P	M16	180	25
02071600190P	M16	190	25
02071600200P	M16	200	25
02071600210P	M16	210	25
02071600220P	M16	220	25
02071600230P	M16	230	25
02071600240P	M16	240	25
02071600250P	M16	250	25
02071800050P	M18	50	25

CÓDIGO	(d)	L	ENVASE
02071800060P	M18	60	25
02071800070P	M18	70	25
02071800080P	M18	80	25
02071800090P	M18	90	25
02071800100P	M18	100	25
02071800110P	M18	110	25
02071800120P	M18	120	25
02071800130P	M18	130	25
02071800140P	M18	140	25
02071800150P	M18	150	25
02071800160P	M18	160	25
02071800170P	M18	170	25
02071800180P	M18	180	25
02071800190P	M18	190	25
02071800200P	M18	200	25
02071800210P	M18	210	25
02071800220P	M18	220	25
02071800230P	M18	230	25
02071800240P	M18	240	25
02071800250P	M18	250	25
02071800270P	M18	270	10
02072000050P	M20	50	25
02072000055P	M20	55	25
02072000060P	M20	60	25
02072000065P	M20	65	25
02072000070P	M20	70	25
02072000080P	M20	80	25
02072000090P	M20	90	25
02072000100P	M20	100	25
02072000110P	M20	110	25
02072000120P	M20	120	25
02072000130P	M20	130	25
02072000140P	M20	140	25
02072000150P	M20	150	10
02072000160P	M20	160	10
02072000170P	M20	170	10
02072000180P	M20	180	10
02072000190P	M20	190	10
02072000200P	M20	200	10
02072000210P	M20	210	10
02072000220P	M20	220	10
02072000230P	M20	230	10
02072000240P	M20	240	10
02072000250P	M20	250	10
02072000260P	M20	260	10
02072000270P	M20	270	10
02072000280P	M20	280	10
02072000290P	M20	290	10
02072000300P	M20	300	10
02072200090P	M22	90	25

Consultar disponibilidad en otras medidas.

Medidas en mm.

0274 DIN 931 CALIDAD 10.9

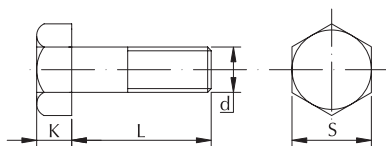

d	M8	M10	M12	M14	M16	M18
K	5,5	7	8	9	10	11,5
S	13	17	19	22	24	27



- Tornillo de cabeza hexagonal de alta resistencia 10.9.
- Rosca parcial.

CÓDIGO	(d)	L	ENVASE
02740800035Z	M8	35	200
02740800040Z	M8	40	200
02740800045Z	M8	45	200
02740800050Z	M8	50	200
02740800055Z	M8	55	200
02740800060Z	M8	60	200
02740800070Z	M8	70	100
02740800080Z	M8	80	100
02740800090Z	M8	90	100
02740800100Z	M8	100	100
02740800120Z	M8	120	50
02741000040Z	M10	40	100
02741000045Z	M10	45	100
02741000050Z	M10	50	100
02741000055Z	M10	55	100
02741000060Z	M10	60	100
02741000070Z	M10	70	50
02741000080Z	M10	80	50
02741000090Z	M10	90	50
02741000100Z	M10	100	50
02741000110Z	M10	110	50
02741000120Z	M10	120	50
02741000130Z	M10	130	50
02741000140Z	M10	140	50
02741000150Z	M10	150	50
02741000160Z	M10	160	50
02741000170Z	M10	170	50
02741000180Z	M10	180	50
02741000190Z	M10	190	50
02741000200Z	M10	200	50
02741200035Z	M12	35	100
02741200040Z	M12	40	100
02741200045Z	M12	45	100
02741200050Z	M12	50	100
02741200055Z	M12	55	100
02741200060Z	M12	60	50
02741200065Z	M12	65	50
02741200070Z	M12	70	50
02741200075Z	M12	75	50
02741200080Z	M12	80	50
02741200085Z	M12	85	50
02741200090Z	M12	90	50
02741200100Z	M12	100	50
02741200110Z	M12	110	50
02741200120Z	M12	120	50
02741200125Z	M12	125	50
02741200130Z	M12	130	25
02741200140Z	M12	140	25
02741200150Z	M12	150	25

CÓDIGO	(d)	L	ENVASE
02741200160Z	M12	160	25
02741200180Z	M12	180	25
02741200200Z	M12	200	10
02741200220Z	M12	220	10
02741400045Z	M14	45	50
02741400050Z	M14	50	50
02741400055Z	M14	55	50
02741400060Z	M14	60	50
02741400065Z	M14	65	50
02741400070Z	M14	70	50
02741400080Z	M14	80	50
02741400090Z	M14	90	25
02741400100Z	M14	100	25
02741400110Z	M14	110	25
02741400120Z	M14	120	25
02741400130Z	M14	130	25
02741400140Z	M14	140	25
02741400150Z	M14	150	25
02741400160Z	M14	160	25
02741400170Z	M14	170	25
02741400180Z	M14	180	25
02741400190Z	M14	190	25
02741400200Z	M14	200	25
02741400220Z	M14	220	25
02741600050Z	M16	50	25
02741600055Z	M16	55	25
02741600060Z	M16	60	25
02741600065Z	M16	65	25
02741600070Z	M16	70	25
02741600075Z	M16	75	25
02741600080Z	M16	80	25
02741600090Z	M16	90	25
02741600100Z	M16	100	25
02741600110Z	M16	110	25
02741600120Z	M16	120	25
02741600130Z	M16	130	25
02741600140Z	M16	140	25
02741600150Z	M16	150	25
02741600160Z	M16	160	25
02741600170Z	M16	170	25
02741600180Z	M16	180	25
02741600190Z	M16	190	25
02741600200Z	M16	200	10
02741800060Z	M18	60	25
02741800070Z	M18	70	25
02741800080Z	M18	80	25
02741800090Z	M18	90	25
02741800100Z	M18	100	25
02741800110Z	M18	110	25

Medidas en mm.

d	M18	M20	M22	M24
K	11,5	12,5	14	15
S	27	30	32	36

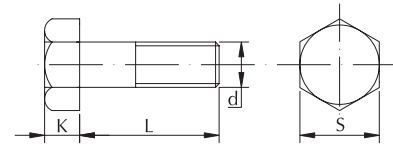

CÓDIGO	(d)	L	ENVASE
02741800120Z	M18	120	25
02741800130Z	M18	130	25
02741800140Z	M18	140	25
02741800150Z	M18	150	25
02741800190Z	M18	190	25
02741800220Z	M18	220	25
02742000050Z	M20	50	25
02742000055Z	M20	55	25
02742000060Z	M20	60	25
02742000070Z	M20	70	25
02742000080Z	M20	80	25
02742000090Z	M20	90	25
02742000100Z	M20	100	25
02742000110Z	M20	110	25
02742000120Z	M20	120	25
02742000130Z	M20	130	10
02742000140Z	M20	140	10
02742000150Z	M20	150	10
02742000160Z	M20	160	10
02742000170Z	M20	170	10
02742000180Z	M20	180	10
02742000190Z	M20	190	10
02742000200Z	M20	200	10
02742000220Z	M20	220	10
02742000240Z	M20	240	5

CÓDIGO	(d)	L	ENVASE
02742000260Z	M20	260	5
02742200070Z	M22	70	25
02742200080Z	M22	80	25
02742200090Z	M22	90	25
02742200100Z	M22	100	10
02742200110Z	M22	110	10
02742200120Z	M22	120	10
02742200130Z	M22	130	10
02742200140Z	M22	140	10
02742200150Z	M22	150	10
02742200160Z	M22	160	10
02742200180Z	M22	180	10
02742200200Z	M22	200	10
02742400080Z	M24	80	25
02742400090Z	M24	90	25
02742400100Z	M24	100	10
02742400110Z	M24	110	10
02742400120Z	M24	120	10
02742400130Z	M24	130	10
02742400140Z	M24	140	10
02742400150Z	M24	150	10
02742400160Z	M24	160	10
02742400180Z	M24	180	10
02742400200Z	M24	200	5
02742400300Z	M24	300	5

Consultar disponibilidad en otras medidas.

0274 DIN 931 CALIDAD 10.9

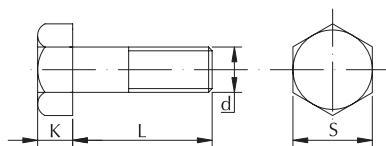

d	M8	M10	M12	M14	M16
K	5,5	7	8	9	10
S	13	17	19	22	24



- Tornillo de cabeza hexagonal de alta resistencia 10.9.
- Rosca parcial.

CÓDIGO	(d)	L	ENVASE
02740800030P	M8	30	200
02740800035P	M8	35	200
02740800040P	M8	40	200
02740800045P	M8	45	200
02740800050P	M8	50	200
02740800055P	M8	55	200
02740800060P	M8	60	200
02740800065P	M8	65	200
02740800070P	M8	70	100
02740800080P	M8	80	100
02740800090P	M8	90	100
02740800100P	M8	100	100
02740800130P	M8	130	50
02740800140P	M8	140	50
02740800150P	M8	150	50
02740800160P	M8	160	50
02740800170P	M8	170	50
02740800180P	M8	180	50
02740800200P	M8	200	50
02741000035P	M10	35	100
02741000040P	M10	40	100
02741000045P	M10	45	100
02741000050P	M10	50	100
02741000055P	M10	55	100
02741000060P	M10	60	100
02741000065P	M10	65	100
02741000070P	M10	70	50
02741000080P	M10	80	50
02741000090P	M10	90	50
02741000100P	M10	100	50
02741000110P	M10	110	50
02741000120P	M10	120	50
02741000130P	M10	130	50
02741000140P	M10	140	50
02741000150P	M10	150	50
02741000160P	M10	160	50
02741000180P	M10	180	50
02741000200P	M10	200	50
02741200035P	M12	35	100
02741200040P	M12	40	100
02741200045P	M12	45	100
02741200050P	M12	50	100
02741200055P	M12	55	100
02741200060P	M12	60	50
02741200065P	M12	65	50
02741200070P	M12	70	50
02741200075P	M12	75	50
02741200080P	M12	80	50
02741200090P	M12	90	50

CÓDIGO	(d)	L	ENVASE
02741200100P	M12	100	50
02741200110P	M12	110	50
02741200120P	M12	120	50
02741200130P	M12	130	25
02741200140P	M12	140	25
02741200150P	M12	150	25
02741200160P	M12	160	25
02741200170P	M12	170	25
02741200180P	M12	180	25
02741200200P	M12	200	25
02741200210P	M12	210	25
02741200220P	M12	220	25
02741200230P	M12	230	25
02741200240P	M12	240	10
02741400045P	M14	45	50
02741400050P	M14	50	50
02741400055P	M14	55	50
02741400060P	M14	60	50
02741400065P	M14	65	50
02741400070P	M14	70	50
02741400080P	M14	80	50
02741400090P	M14	90	25
02741400100P	M14	100	25
02741400110P	M14	110	25
02741400120P	M14	120	25
02741400130P	M14	130	25
02741400140P	M14	140	25
02741400150P	M14	150	25
02741400160P	M14	160	25
02741400170P	M14	170	25
02741400180P	M14	180	25
02741400190P	M14	190	25
02741400200P	M14	200	25
02741600050P	M16	50	25
02741600055P	M16	55	25
02741600060P	M16	60	25
02741600070P	M16	70	25
02741600080P	M16	80	25
02741600090P	M16	90	25
02741600100P	M16	100	25
02741600110P	M16	110	25
02741600120P	M16	120	25
02741600130P	M16	130	25
02741600140P	M16	140	25
02741600150P	M16	150	25
02741600160P	M16	160	25
02741600170P	M16	170	25
02741600180P	M16	180	25
02741600190P	M16	190	25

Medidas en mm.

d	M16	M18	M20	M22	M24
K	10	11,5	12,5	14	15
S	24	27	30	32	36

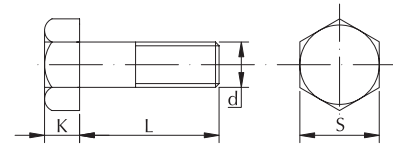

CÓDIGO	(d)	L	ENVASE
02741600200P	M16	200	10
02741600210P	M16	210	10
02741600220P	M16	220	10
02741600230P	M16	230	10
02741600240P	M16	240	10
02741600250P	M16	250	10
02741800050P	M18	50	25
02741800060P	M18	60	25
02741800070P	M18	70	25
02741800080P	M18	80	25
02741800090P	M18	90	25
02741800100P	M18	100	25
02741800110P	M18	110	25
02741800120P	M18	120	25
02741800130P	M18	130	25
02741800140P	M18	140	25
02741800150P	M18	150	25
02741800160P	M18	160	25
02741800170P	M18	170	25
02741800180P	M18	180	25
02741800190P	M18	190	25
02741800200P	M18	200	10
02742000050P	M20	50	25
02742000055P	M20	55	25
02742000060P	M20	60	25
02742000065P	M20	65	25
02742000070P	M20	70	25
02742000080P	M20	80	25
02742000090P	M20	90	25
02742000100P	M20	100	25
02742000110P	M20	110	25
02742000120P	M20	120	25
02742000130P	M20	130	10
02742000140P	M20	140	10
02742000150P	M20	150	10
02742000160P	M20	160	10
02742000170P	M20	170	10

CÓDIGO	(d)	L	ENVASE
02742000180P	M20	180	10
02742000190P	M20	190	10
02742000200P	M20	200	10
02742000210P	M20	210	10
02742000220P	M20	220	10
02742000230P	M20	230	10
02742000240P	M20	240	10
02742000250P	M20	250	10
02742000260P	M20	260	5
02742000270P	M20	270	5
02742000280P	M20	280	5
02742000290P	M20	290	5
02742000300P	M20	300	5
02742200070P	M22	70	25
02742200080P	M22	80	25
02742200090P	M22	90	25
02742200100P	M22	100	10
02742200120P	M22	120	10
02742200130P	M22	130	10
02742200140P	M22	140	10
02742200150P	M22	150	10
02742200160P	M22	160	10
02742200180P	M22	180	10
02742200200P	M22	200	10
02742200250P	M22	250	5
02742400090P	M24	90	25
02742400100P	M24	100	10
02742400110P	M24	110	10
02742400120P	M24	120	10
02742400130P	M24	130	10
02742400140P	M24	140	10
02742400150P	M24	150	10
02742400160P	M24	160	10
02742400170P	M24	170	10
02742400180P	M24	180	10
02742400200P	M24	200	5
02742400270P	M24	270	5

Consultar disponibilidad en otras medidas.

0208 DIN 6921 CALIDAD 8.8

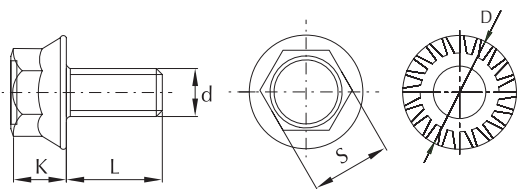

d	M6	M8	M10
K	6,2	8,1	9,1
S	10	13	15
D máx.	14,2	18	22,3



- Tornillo de cabeza hexagonal y arandela estampada.
- Alta resistencia 8.8
- Estriado bajo cabeza que realiza la función de freno sobre la superficie a fijar.

CÓDIGO	(d)	L	ENVASE
02080600012Z	M6	12	500
02080600016Z	M6	16	500
02080600020Z	M6	20	200
02080600025Z	M6	25	500
02080600030Z	M6	30	500
02080600035Z	M6	35	500
02080600040Z	M6	40	200
02080600045Z	M6	45	500
02080800015Z	M8	15	200
02080800016Z	M8	16	200
02080800020Z	M8	20	200

CÓDIGO	(d)	L	ENVASE
02080800025Z	M8	25	200
02080800030Z	M8	30	200
02080800035Z	M8	35	200
02080800040Z	M8	40	200
02080800045Z	M8	45	200
02080800050Z	M8	50	200
02080800055Z	M8	55	200
02080800060Z	M8	60	200
02081000030Z	M10	30	200
02081000040Z	M10	40	100
02081000050Z	M10	50	100

Consultar disponibilidad en otras medidas.

Medidas en mm.



0209 DIN 912 CALIDAD 8.8

d	M3	M4	M5	M6	M8
D	5,5	7	8,5	10	13
K	3	4	5	6	7
S	2,5	3	4	5	6

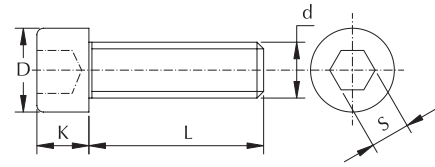

- Tornillo de cabeza cilíndrica y huella hexagonal.
- Alta resistencia 8.8



CÓDIGO	(d)	L	○	ENVASE
02090300006Z	M3	6	ALLEN 2,5	1000
02090300008Z	M3	8	ALLEN 2,5	1000
02090300010Z	M3	10	ALLEN 2,5	1000
02090300012Z	M3	12	ALLEN 2,5	1000
02090300014Z	M3	14	ALLEN 2,5	1000
02090300016Z	M3	16	ALLEN 2,5	1000
02090300020Z	M3	20	ALLEN 2,5	1000
02090300025Z	M3	25	ALLEN 2,5	1000
02090300030Z	M3	30	ALLEN 2,5	1000
02090300035Z	M3	35	ALLEN 2,5	1000
02090300040Z	M3	40	ALLEN 2,5	1000
02090300045Z	M3	45	ALLEN 2,5	500
02090300050Z	M3	50	ALLEN 2,5	500
02090300055Z	M3	55	ALLEN 2,5	500
02090300060Z	M3	60	ALLEN 2,5	500
02090400006Z	M4	6	ALLEN 3	1000
02090400008Z	M4	8	ALLEN 3	1000
02090400010Z	M4	10	ALLEN 3	1000
02090400012Z	M4	12	ALLEN 3	1000
02090400014Z	M4	14	ALLEN 3	1000
02090400015Z	M4	15	ALLEN 3	500
02090400016Z	M4	16	ALLEN 3	1000
02090400018Z	M4	18	ALLEN 3	500
02090400020Z	M4	20	ALLEN 3	1000
02090400025Z	M4	25	ALLEN 3	1000
02090400030Z	M4	30	ALLEN 3	1000
02090400035Z	M4	35	ALLEN 3	1000
02090400040Z	M4	40	ALLEN 3	1000
02090400045Z	M4	45	ALLEN 3	1000
02090400050Z	M4	50	ALLEN 3	500
02090400055Z	M4	55	ALLEN 3	200
02090400060Z	M4	60	ALLEN 3	200
02090400070Z	M4	70	ALLEN 3	200
02090500006Z	M5	6	ALLEN 4	1000
02090500008Z	M5	8	ALLEN 4	1000
02090500010Z	M5	10	ALLEN 4	1000
02090500012Z	M5	12	ALLEN 4	1000
02090500014Z	M5	14	ALLEN 4	1000
02090500016Z	M5	16	ALLEN 4	1000
02090500020Z	M5	20	ALLEN 4	1000
02090500025Z	M5	25	ALLEN 4	1000
02090500030Z	M5	30	ALLEN 4	1000
02090500035Z	M5	35	ALLEN 4	1000
02090500040Z	M5	40	ALLEN 4	500
02090500045Z	M5	45	ALLEN 4	500

CÓDIGO	(d)	L	○	ENVASE
02090500050Z	M5	50	ALLEN 4	500
02090500055Z	M5	55	ALLEN 4	200
02090500060Z	M5	60	ALLEN 4	200
02090500065Z	M5	65	ALLEN 4	200
02090500070Z	M5	70	ALLEN 4	200
02090500075Z	M5	75	ALLEN 4	200
02090500080Z	M5	80	ALLEN 4	200
02090500090Z	M5	90	ALLEN 4	200
02090600008Z	M6	8	ALLEN 5	500
02090600010Z	M6	10	ALLEN 5	500
02090600012Z	M6	12	ALLEN 5	500
02090600014Z	M6	14	ALLEN 5	500
02090600016Z	M6	16	ALLEN 5	500
02090600018Z	M6	18	ALLEN 5	500
02090600020Z	M6	20	ALLEN 5	500
02090600022Z	M6	22	ALLEN 5	500
02090600025Z	M6	25	ALLEN 5	200
02090600030Z	M6	30	ALLEN 5	200
02090600035Z	M6	35	ALLEN 5	200
02090600040Z	M6	40	ALLEN 5	200
02090600045Z	M6	45	ALLEN 5	200
02090600050Z	M6	50	ALLEN 5	200
02090600055Z	M6	55	ALLEN 5	200
02090600060Z	M6	60	ALLEN 5	200
02090600065Z	M6	65	ALLEN 5	200
02090600070Z	M6	70	ALLEN 5	100
02090600080Z	M6	80	ALLEN 5	100
02090600090Z	M6	90	ALLEN 5	200
02090600100Z	M6	100	ALLEN 5	100
02090600110Z	M6	110	ALLEN 5	100
02090600120Z	M6	120	ALLEN 5	100
02090800010Z	M8	10	ALLEN 6	200
02090800012Z	M8	12	ALLEN 6	200
02090800014Z	M8	14	ALLEN 6	100
02090800016Z	M8	16	ALLEN 6	100
02090800020Z	M8	20	ALLEN 6	200
02090800025Z	M8	25	ALLEN 6	200
02090800030Z	M8	30	ALLEN 6	100
02090800035Z	M8	35	ALLEN 6	100
02090800040Z	M8	40	ALLEN 6	100
02090800045Z	M8	45	ALLEN 6	100
02090800050Z	M8	50	ALLEN 6	100
02090800055Z	M8	55	ALLEN 6	200
02090800060Z	M8	60	ALLEN 6	100
02090800065Z	M8	65	ALLEN 6	100

0209 DIN 912 CALIDAD 8.8

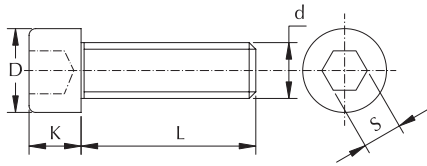

d	M8	M10	M12	M14	M16
D	13	16	18	21	24
K	8	10	12	14	16
S	6	8	10	12	14

CÓDIGO	(d)	L	○	ENVASE
02090800070Z	M8	70	ALLEN 6	100
02090800080Z	M8	80	ALLEN 6	100
02090800090Z	M8	90	ALLEN 6	100
02090800100Z	M8	100	ALLEN 6	100
02090800110Z	M8	110	ALLEN 6	100
02090800120Z	M8	120	ALLEN 6	100
02090800130Z	M8	130	ALLEN 6	100
02090800140Z	M8	140	ALLEN 6	50
02090800150Z	M8	150	ALLEN 6	50
02091000010Z	M10	10	ALLEN 8	200
02091000012Z	M10	12	ALLEN 8	200
02091000014Z	M10	14	ALLEN 8	100
02091000016Z	M10	16	ALLEN 8	100
02091000018Z	M10	18	ALLEN 8	100
02091000020Z	M10	20	ALLEN 8	200
02091000025Z	M10	25	ALLEN 8	100
02091000030Z	M10	30	ALLEN 8	100
02091000035Z	M10	35	ALLEN 8	100
02091000040Z	M10	40	ALLEN 8	100
02091000045Z	M10	45	ALLEN 8	100
02091000050Z	M10	50	ALLEN 8	100
02091000055Z	M10	55	ALLEN 8	100
02091000060Z	M10	60	ALLEN 8	100
02091000065Z	M10	65	ALLEN 8	100
02091000070Z	M10	70	ALLEN 8	100
02091000075Z	M10	75	ALLEN 8	100
02091000080Z	M10	80	ALLEN 8	50
02091000090Z	M10	90	ALLEN 8	50
02091000100Z	M10	100	ALLEN 8	50
02091000110Z	M10	110	ALLEN 8	100
02091000120Z	M10	120	ALLEN 8	50
02091000130Z	M10	130	ALLEN 8	100
02091000140Z	M10	140	ALLEN 8	50
02091000150Z	M10	150	ALLEN 8	50
02091200016Z	M12	16	ALLEN 10	100
02091200020Z	M12	20	ALLEN 10	100
02091200025Z	M12	25	ALLEN 10	100
02091200030Z	M12	30	ALLEN 10	100
02091200035Z	M12	35	ALLEN 10	100
02091200040Z	M12	40	ALLEN 10	100
02091200045Z	M12	45	ALLEN 10	100
02091200050Z	M12	50	ALLEN 10	100
02091200055Z	M12	55	ALLEN 10	100
02091200060Z	M12	60	ALLEN 10	50
02091200065Z	M12	65	ALLEN 10	50
02091200070Z	M12	70	ALLEN 10	50
02091200080Z	M12	80	ALLEN 10	50
02091200090Z	M12	90	ALLEN 10	50
02091200100Z	M12	100	ALLEN 10	50

CÓDIGO	(d)	L	○	ENVASE
02091200110Z	M12	110	ALLEN 10	50
02091200120Z	M12	120	ALLEN 10	50
02091200130Z	M12	130	ALLEN 10	50
02091200140Z	M12	140	ALLEN 10	50
02091200150Z	M12	150	ALLEN 10	50
02091400020Z	M14	20	ALLEN 12	100
02091400025Z	M14	25	ALLEN 12	100
02091400030Z	M14	30	ALLEN 12	100
02091400035Z	M14	35	ALLEN 12	100
02091400040Z	M14	40	ALLEN 12	50
02091400045Z	M14	45	ALLEN 12	50
02091400050Z	M14	50	ALLEN 12	50
02091400055Z	M14	55	ALLEN 12	100
02091400060Z	M14	60	ALLEN 12	50
02091400065Z	M14	65	ALLEN 12	50
02091400070Z	M14	70	ALLEN 12	25
02091400075Z	M14	75	ALLEN 12	50
02091400080Z	M14	80	ALLEN 12	25
02091400090Z	M14	90	ALLEN 12	25
02091400100Z	M14	100	ALLEN 12	25
02091400110Z	M14	110	ALLEN 12	50
02091400120Z	M14	120	ALLEN 12	50
02091400130Z	M14	130	ALLEN 12	50
02091400140Z	M14	140	ALLEN 12	25
02091400150Z	M14	150	ALLEN 12	25
02091600020Z	M16	20	ALLEN 14	50
02091600025Z	M16	25	ALLEN 14	100
02091600030Z	M16	30	ALLEN 14	50
02091600035Z	M16	35	ALLEN 14	100
02091600040Z	M16	40	ALLEN 14	50
02091600045Z	M16	45	ALLEN 14	50
02091600050Z	M16	50	ALLEN 14	50
02091600055Z	M16	55	ALLEN 14	50
02091600060Z	M16	60	ALLEN 14	50
02091600065Z	M16	65	ALLEN 14	50
02091600070Z	M16	70	ALLEN 14	50
02091600080Z	M16	80	ALLEN 14	50
02091600090Z	M16	90	ALLEN 14	50
02091600100Z	M16	100	ALLEN 14	25
02091600110Z	M16	110	ALLEN 14	50
02091600120Z	M16	120	ALLEN 14	25
02091600130Z	M16	130	ALLEN 14	25
02091600140Z	M16	140	ALLEN 14	25
02091600150Z	M16	150	ALLEN 14	25
02091600160Z	M16	160	ALLEN 14	25
02091600170Z	M16	170	ALLEN 14	25
02091600180Z	M16	180	ALLEN 14	25
02091600190Z	M16	190	ALLEN 14	25
02091600200Z	M16	200	ALLEN 14	10

Consultar disponibilidad en otras medidas.

Medidas en mm.



Puntas de atornillar disponibles en página 272.

0209 DIN 912 CALIDAD 8.8

d	M3	M4	M5	M6	M8
D	5,5	7	8,5	10	13
K	3	4	5	6	7
S	2,5	3	4	5	6

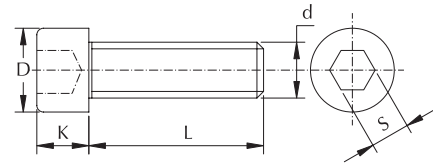

- Tornillo de cabeza cilíndrica y huella hexagonal.
- Alta resistencia 8.8



CÓDIGO	(d)	L	○	ENVASE
02090300006P	M3	6	ALLEN 2,5	1000
02090300008P	M3	8	ALLEN 2,5	1000
02090300010P	M3	10	ALLEN 2,5	1000
02090300012P	M3	12	ALLEN 2,5	1000
02090300014P	M3	14	ALLEN 2,5	1000
02090300016P	M3	16	ALLEN 2,5	1000
02090300020P	M3	20	ALLEN 2,5	1000
02090300025P	M3	25	ALLEN 2,5	1000
02090300030P	M3	30	ALLEN 2,5	1000
02090300035P	M3	35	ALLEN 2,5	1000
02090300040P	M3	40	ALLEN 2,5	1000
02090300045P	M3	45	ALLEN 2,5	500
02090300050P	M3	50	ALLEN 2,5	500
02090300055P	M3	55	ALLEN 2,5	500
02090300060P	M3	60	ALLEN 2,5	500
02090400006P	M4	6	ALLEN 3	500
02090400008P	M4	8	ALLEN 3	500
02090400010P	M4	10	ALLEN 3	500
02090400012P	M4	12	ALLEN 3	500
02090400014P	M4	14	ALLEN 3	500
02090400015P	M4	15	ALLEN 3	500
02090400016P	M4	16	ALLEN 3	500
02090400018P	M4	18	ALLEN 3	500
02090400020P	M4	20	ALLEN 3	500
02090400025P	M4	25	ALLEN 3	500
02090400030P	M4	30	ALLEN 3	1000
02090400035P	M4	35	ALLEN 3	1000
02090400040P	M4	40	ALLEN 3	500
02090400045P	M4	45	ALLEN 3	500
02090400050P	M4	50	ALLEN 3	500
02090400055P	M4	55	ALLEN 3	200
02090400060P	M4	60	ALLEN 3	200
02090400065P	M4	65	ALLEN 3	200
02090400070P	M4	70	ALLEN 3	200
02090500006P	M5	6	ALLEN 4	500
02090500008P	M5	8	ALLEN 4	500
02090500010P	M5	10	ALLEN 4	1000
02090500012P	M5	12	ALLEN 4	500
02090500014P	M5	14	ALLEN 4	1000
02090500016P	M5	16	ALLEN 4	500
02090500018P	M5	18	ALLEN 4	1000
02090500020P	M5	20	ALLEN 4	1000
02090500025P	M5	25	ALLEN 4	500
02090500030P	M5	30	ALLEN 4	500
02090500035P	M5	35	ALLEN 4	500

CÓDIGO	(d)	L	○	ENVASE
02090500040P	M5	40	ALLEN 4	500
02090500045P	M5	45	ALLEN 4	200
02090500050P	M5	50	ALLEN 4	200
02090500055P	M5	55	ALLEN 4	200
02090500060P	M5	60	ALLEN 4	200
02090500065P	M5	65	ALLEN 4	100
02090500070P	M5	70	ALLEN 4	200
02090500075P	M5	75	ALLEN 4	200
02090500080P	M5	80	ALLEN 4	100
02090600008P	M6	8	ALLEN 5	500
02090600010P	M6	10	ALLEN 5	500
02090600012P	M6	12	ALLEN 5	500
02090600014P	M6	14	ALLEN 5	500
02090600015P	M6	15	ALLEN 5	500
02090600016P	M6	16	ALLEN 5	500
02090600018P	M6	18	ALLEN 5	500
02090600020P	M6	20	ALLEN 5	500
02090600025P	M6	25	ALLEN 5	500
02090600030P	M6	30	ALLEN 5	500
02090600035P	M6	35	ALLEN 5	200
02090600040P	M6	40	ALLEN 5	500
02090600045P	M6	45	ALLEN 5	200
02090600050P	M6	50	ALLEN 5	400
02090600055P	M6	55	ALLEN 5	200
02090600060P	M6	60	ALLEN 5	200
02090600065P	M6	65	ALLEN 5	200
02090600070P	M6	70	ALLEN 5	200
02090600080P	M6	80	ALLEN 5	200
02090600090P	M6	90	ALLEN 5	100
02090600100P	M6	100	ALLEN 5	100
02090800010P	M8	10	ALLEN 6	200
02090800012P	M8	12	ALLEN 6	100
02090800014P	M8	14	ALLEN 6	200
02090800016P	M8	16	ALLEN 6	200
02090800018P	M8	18	ALLEN 6	200
02090800020P	M8	20	ALLEN 6	200
02090800025P	M8	25	ALLEN 6	100
02090800030P	M8	30	ALLEN 6	200
02090800035P	M8	35	ALLEN 6	100
02090800040P	M8	40	ALLEN 6	100
02090800045P	M8	45	ALLEN 6	100
02090800050P	M8	50	ALLEN 6	100
02090800055P	M8	55	ALLEN 6	100
02090800060P	M8	60	ALLEN 6	100
02090800065P	M8	65	ALLEN 6	100

0209 DIN 912 CALIDAD 8.8

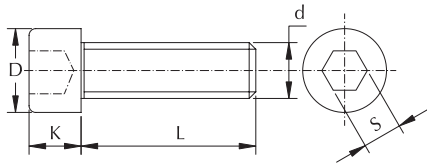

d	M8	M10	M12	M14	M16	M20
D	13	16	18	21	24	30
K	8	10	12	14	16	20
S	6	8	10	12	14	17

CÓDIGO	(d)	L	Ø	ENVASE
02090800070P	M8	70	ALLEN 6	100
02090800080P	M8	80	ALLEN 6	100
02090800090P	M8	90	ALLEN 6	100
02090800100P	M8	100	ALLEN 6	100
02090800110P	M8	110	ALLEN 6	100
02090800120P	M8	120	ALLEN 6	100
02090800130P	M8	130	ALLEN 6	100
02090800140P	M8	140	ALLEN 6	50
02090800150P	M8	150	ALLEN 6	50
02091000010P	M10	10	ALLEN 8	250
02091000012P	M10	12	ALLEN 8	200
02091000014P	M10	14	ALLEN 8	100
02091000016P	M10	16	ALLEN 8	100
02091000020P	M10	20	ALLEN 8	200
02091000025P	M10	25	ALLEN 8	100
02091000030P	M10	30	ALLEN 8	100
02091000035P	M10	35	ALLEN 8	100
02091000040P	M10	40	ALLEN 8	100
02091000045P	M10	45	ALLEN 8	100
02091000050P	M10	50	ALLEN 8	100
02091000055P	M10	55	ALLEN 8	100
02091000060P	M10	60	ALLEN 8	100
02091000065P	M10	65	ALLEN 8	100
02091000070P	M10	70	ALLEN 8	100
02091000080P	M10	80	ALLEN 8	100
02091000085P	M10	85	ALLEN 8	100
02091000090P	M10	90	ALLEN 8	100
02091000095P	M10	95	ALLEN 8	100
02091000100P	M10	100	ALLEN 8	100
02091000110P	M10	110	ALLEN 8	100
02091000120P	M10	120	ALLEN 8	100
02091000130P	M10	130	ALLEN 8	100
02091000135P	M10	135	ALLEN 8	50
02091000140P	M10	140	ALLEN 8	50
02091000150P	M10	150	ALLEN 8	50
02091200016P	M12	16	ALLEN 10	100
02091200020P	M12	20	ALLEN 10	100
02091200025P	M12	25	ALLEN 10	100
02091200030P	M12	30	ALLEN 10	100
02091200035P	M12	35	ALLEN 10	100
02091200040P	M12	40	ALLEN 10	100
02091200045P	M12	45	ALLEN 10	100
02091200050P	M12	50	ALLEN 10	100
02091200055P	M12	55	ALLEN 10	100
02091200060P	M12	60	ALLEN 10	50
02091200065P	M12	65	ALLEN 10	50
02091200070P	M12	70	ALLEN 10	50
02091200080P	M12	80	ALLEN 10	50
02091200090P	M12	90	ALLEN 10	50

CÓDIGO	(d)	L	Ø	ENVASE
02091200100P	M12	100	ALLEN 10	50
02091200110P	M12	110	ALLEN 10	100
02091200120P	M12	120	ALLEN 10	50
02091200130P	M12	130	ALLEN 10	50
02091200140P	M12	140	ALLEN 10	50
02091200150P	M12	150	ALLEN 10	50
02091400025P	M14	25	ALLEN 12	100
02091400030P	M14	30	ALLEN 12	100
02091400035P	M14	35	ALLEN 12	100
02091400040P	M14	40	ALLEN 12	100
02091400045P	M14	45	ALLEN 12	50
02091400050P	M14	50	ALLEN 12	50
02091400055P	M14	55	ALLEN 12	100
02091400060P	M14	60	ALLEN 12	50
02091400065P	M14	65	ALLEN 12	50
02091400070P	M14	70	ALLEN 12	25
02091400080P	M14	80	ALLEN 12	25
02091400090P	M14	90	ALLEN 12	25
02091400100P	M14	100	ALLEN 12	25
02091400110P	M14	110	ALLEN 12	50
02091400120P	M14	120	ALLEN 12	50
02091400130P	M14	130	ALLEN 12	50
02091400140P	M14	140	ALLEN 12	25
02091400150P	M14	150	ALLEN 12	25
02091600020P	M16	20	ALLEN 14	50
02091600025P	M16	25	ALLEN 14	50
02091600030P	M16	30	ALLEN 14	100
02091600035P	M16	35	ALLEN 14	100
02091600040P	M16	40	ALLEN 14	50
02091600045P	M16	45	ALLEN 14	50
02091600050P	M16	50	ALLEN 14	50
02091600055P	M16	55	ALLEN 14	50
02091600060P	M16	60	ALLEN 14	50
02091600065P	M16	65	ALLEN 14	25
02091600070P	M16	70	ALLEN 14	50
02091600080P	M16	80	ALLEN 14	50
02091600090P	M16	90	ALLEN 14	50
02091600100P	M16	100	ALLEN 14	25
02091600110P	M16	110	ALLEN 14	50
02091600120P	M16	120	ALLEN 14	25
02091600130P	M16	130	ALLEN 14	25
02091600140P	M16	140	ALLEN 14	25
02091600150P	M16	150	ALLEN 14	25
02091600160P	M16	160	ALLEN 14	25
02091600170P	M16	170	ALLEN 14	25
02091600180P	M16	180	ALLEN 14	25
02091600190P	M16	190	ALLEN 14	25
02091600200P	M16	200	ALLEN 14	25
02092000110P	M20	110	ALLEN 17	10

Consultar disponibilidad en otras medidas.

Medidas en mm.



Puntas de atornillar disponibles en página 272.

0272 DIN 912 CALIDAD 12.9

d	M6	M8	M10	M12
D	10	13	16	18
K	6	7	10	12
S	5	6	8	10

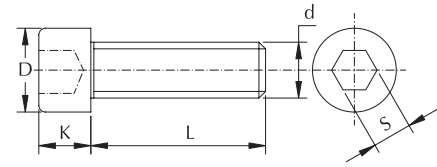

- Tornillo de cabeza cilíndrica y huella hexagonal.
- Alta resistencia 12.9.



CÓDIGO	(d)	L	○	ENVASE
02720600008P	M6	8	ALLEN 5	500
02720600010P	M6	10	ALLEN 5	500
02720600012P	M6	12	ALLEN 5	500
02720600014P	M6	14	ALLEN 5	500
02720600016P	M6	16	ALLEN 5	500
02720600018P	M6	18	ALLEN 5	500
02720600020P	M6	20	ALLEN 5	500
02720600025P	M6	25	ALLEN 5	500
02720600030P	M6	30	ALLEN 5	200
02720600035P	M6	35	ALLEN 5	200
02720600040P	M6	40	ALLEN 5	200
02720600045P	M6	45	ALLEN 5	200
02720600050P	M6	50	ALLEN 5	200
02720600055P	M6	55	ALLEN 5	200
02720600060P	M6	60	ALLEN 5	200
02720600065P	M6	65	ALLEN 5	200
02720600070P	M6	70	ALLEN 5	200
02720600075P	M6	75	ALLEN 5	200
02720600080P	M6	80	ALLEN 5	200
02720600085P	M6	85	ALLEN 5	200
02720600090P	M6	90	ALLEN 5	200
02720600100P	M6	100	ALLEN 5	100
02720600110P	M6	110	ALLEN 5	100
02720600120P	M6	120	ALLEN 5	100
02720800010P	M8	10	ALLEN 6	200
02720800012P	M8	12	ALLEN 6	200
02720800014P	M8	14	ALLEN 6	200
02720800016P	M8	16	ALLEN 6	200
02720800018P	M8	18	ALLEN 6	200
02720800020P	M8	20	ALLEN 6	200
02720800025P	M8	25	ALLEN 6	200
02720800030P	M8	30	ALLEN 6	200
02720800035P	M8	35	ALLEN 6	200
02720800040P	M8	40	ALLEN 6	200
02720800045P	M8	45	ALLEN 6	200
02720800050P	M8	50	ALLEN 6	200
02720800055P	M8	55	ALLEN 6	200
02720800060P	M8	60	ALLEN 6	200
02720800065P	M8	65	ALLEN 6	200
02720800070P	M8	70	ALLEN 6	200
02720800080P	M8	80	ALLEN 6	200
02720800090P	M8	90	ALLEN 6	100
02720800100P	M8	100	ALLEN 6	100
02720800110P	M8	110	ALLEN 6	100
02720800120P	M8	120	ALLEN 6	100

CÓDIGO	(d)	L	○	ENVASE
02720800130P	M8	130	ALLEN 6	100
02720800140P	M8	140	ALLEN 6	100
02720800150P	M8	150	ALLEN 6	50
02720800180P	M8	180	ALLEN 6	50
02721000012P	M10	12	ALLEN 8	200
02721000014P	M10	14	ALLEN 8	200
02721000016P	M10	16	ALLEN 8	200
02721000018P	M10	18	ALLEN 8	200
02721000020P	M10	20	ALLEN 8	200
02721000025P	M10	25	ALLEN 8	200
02721000030P	M10	30	ALLEN 8	200
02721000035P	M10	35	ALLEN 8	100
02721000040P	M10	40	ALLEN 8	100
02721000045P	M10	45	ALLEN 8	100
02721000050P	M10	50	ALLEN 8	100
02721000055P	M10	55	ALLEN 8	100
02721000060P	M10	60	ALLEN 8	100
02721000065P	M10	65	ALLEN 8	100
02721000070P	M10	70	ALLEN 8	100
02721000080P	M10	80	ALLEN 8	100
02721000085P	M10	85	ALLEN 8	100
02721000090P	M10	90	ALLEN 8	100
02721000095P	M10	95	ALLEN 8	100
02721000100P	M10	100	ALLEN 8	100
02721000110P	M10	110	ALLEN 8	50
02721000120P	M10	120	ALLEN 8	50
02721000130P	M10	130	ALLEN 8	50
02721000135P	M10	135	ALLEN 8	50
02721000140P	M10	140	ALLEN 8	50
02721000150P	M10	150	ALLEN 8	50
02721200016P	M12	16	ALLEN 10	100
02721200020P	M12	20	ALLEN 10	100
02721200025P	M12	25	ALLEN 10	100
02721200030P	M12	30	ALLEN 10	100
02721200035P	M12	35	ALLEN 10	100
02721200040P	M12	40	ALLEN 10	100
02721200045P	M12	45	ALLEN 10	100
02721200050P	M12	50	ALLEN 10	100
02721200055P	M12	55	ALLEN 10	100
02721200060P	M12	60	ALLEN 10	100
02721200065P	M12	65	ALLEN 10	100
02721200070P	M12	70	ALLEN 10	50
02721200075P	M12	75	ALLEN 10	50
02721200080P	M12	80	ALLEN 10	50
02721200090P	M12	90	ALLEN 10	50

0272 DIN 912 CALIDAD 12.9

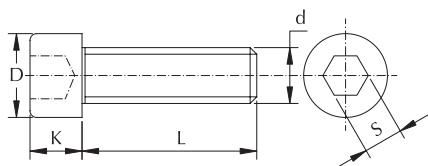

d	M12	M14	M16
D	18	21	24
K	12	14	16
S	10	12	14

CÓDIGO	(d)	L	⊙	ENVASE
02721200100P	M12	100	ALLEN 10	50
02721200110P	M12	110	ALLEN 10	50
02721200120P	M12	120	ALLEN 10	50
02721200130P	M12	130	ALLEN 10	50
02721200140P	M12	140	ALLEN 10	50
02721200150P	M12	150	ALLEN 10	50
02721200160P	M12	160	ALLEN 10	25
02721400020P	M14	20	ALLEN 12	100
02721400025P	M14	25	ALLEN 12	100
02721400030P	M14	30	ALLEN 12	100
02721400035P	M14	35	ALLEN 12	100
02721400040P	M14	40	ALLEN 12	50
02721400045P	M14	45	ALLEN 12	50
02721400050P	M14	50	ALLEN 12	50
02721400055P	M14	55	ALLEN 12	50
02721400060P	M14	60	ALLEN 12	50
02721400065P	M14	65	ALLEN 12	50
02721400070P	M14	70	ALLEN 12	50
02721400080P	M14	80	ALLEN 12	50
02721400090P	M14	90	ALLEN 12	50
02721400100P	M14	100	ALLEN 12	50
02721400110P	M14	110	ALLEN 12	50
02721400120P	M14	120	ALLEN 12	50
02721400130P	M14	130	ALLEN 12	50
02721400140P	M14	140	ALLEN 12	25
02721400150P	M14	150	ALLEN 12	25

CÓDIGO	(d)	L	⊙	ENVASE
02721600020P	M16	20	ALLEN 14	50
02721600025P	M16	25	ALLEN 14	50
02721600030P	M16	30	ALLEN 14	50
02721600035P	M16	35	ALLEN 14	50
02721600040P	M16	40	ALLEN 14	50
02721600045P	M16	45	ALLEN 14	50
02721600050P	M16	50	ALLEN 14	50
02721600055P	M16	55	ALLEN 14	50
02721600060P	M16	60	ALLEN 14	50
02721600065P	M16	65	ALLEN 14	25
02721600070P	M16	70	ALLEN 14	25
02721600075P	M16	75	ALLEN 14	25
02721600080P	M16	80	ALLEN 14	25
02721600090P	M16	90	ALLEN 14	25
02721600100P	M16	100	ALLEN 14	25
02721600110P	M16	110	ALLEN 14	25
02721600120P	M16	120	ALLEN 14	25
02721600130P	M16	130	ALLEN 14	25
02721600140P	M16	140	ALLEN 14	25
02721600150P	M16	150	ALLEN 14	25
02721600160P	M16	160	ALLEN 14	25
02721600170P	M16	170	ALLEN 14	25
02721600180P	M16	180	ALLEN 14	25
02721600190P	M16	190	ALLEN 14	25
02721600200P	M16	200	ALLEN 14	25

Consultar disponibilidad en otras medidas.

0210 DIN 7984 CALIDAD 8.8

d	M4	M5	M6	M8	M10
D	7	8,5	10	13	16
K	2,8	3,5	4	5	6
S	2,5	3	4	5	7

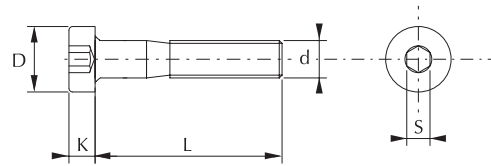

- Tornillo de cabeza cilíndrica baja y huella hexagonal.
- Alta Resistencia 8.8



CÓDIGO	(d)	L	○	ENVASE
02100400006P	M4	6	ALLEN 2,5	1000
02100400008P	M4	8	ALLEN 2,5	1000
02100400010P	M4	10	ALLEN 2,5	1000
02100400012P	M4	12	ALLEN 2,5	1000
02100400016P	M4	16	ALLEN 2,5	1000
02100400018P	M4	18	ALLEN 2,5	500
02100400020P	M4	20	ALLEN 2,5	1000
02100400025P	M4	25	ALLEN 2,5	1000
02100400030P	M4	30	ALLEN 2,5	500
02100400035P	M4	35	ALLEN 2,5	500
02100400040P	M4	40	ALLEN 2,5	1000
02100500008P	M5	8	ALLEN 3	500
02100500010P	M5	10	ALLEN 3	500
02100500012P	M5	12	ALLEN 3	500
02100500014P	M5	14	ALLEN 3	500
02100500016P	M5	16	ALLEN 3	500
02100500020P	M5	20	ALLEN 3	500
02100500025P	M5	25	ALLEN 3	500
02100500030P	M5	30	ALLEN 3	200
02100500035P	M5	35	ALLEN 3	100
02100500040P	M5	40	ALLEN 3	100

CÓDIGO	(d)	L	○	ENVASE
02100600008P	M6	8	ALLEN 4	1000
02100600010P	M6	10	ALLEN 4	500
02100600012P	M6	12	ALLEN 4	500
02100600014P	M6	14	ALLEN 4	500
02100600016P	M6	16	ALLEN 4	500
02100600020P	M6	20	ALLEN 4	500
02100600025P	M6	25	ALLEN 4	500
02100600030P	M6	30	ALLEN 4	100
02100600035P	M6	35	ALLEN 4	100
02100600040P	M6	40	ALLEN 4	100
02100800010P	M8	10	ALLEN 5	200
02100800016P	M8	16	ALLEN 5	100
02100800018P	M8	18	ALLEN 5	100
02100800020P	M8	20	ALLEN 5	100
02100800025P	M8	25	ALLEN 5	100
02100800030P	M8	30	ALLEN 5	100
02100800035P	M8	35	ALLEN 5	100
02100800040P	M8	40	ALLEN 5	100
02100800045P	M8	45	ALLEN 5	100
02100800050P	M8	50	ALLEN 5	100
02101000060P	M10	60	ALLEN 7	100

Consultar disponibilidad en otras medidas.



0211 ISO 10642 (DIN 7991) CALIDAD 8.8

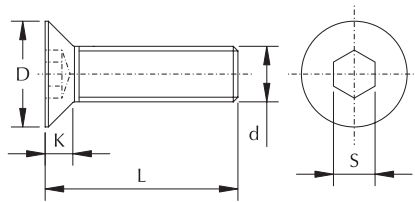

d	M3	M4	M5	M6	M8	M10
D	6	8	10	12	16	20
K	1,8	2,4	2,8	3,3	4,4	5,5
S	2	2,5	3	4	5	6



- Tornillo de cabeza avellanada y huella hexagonal.
- Alta Resistencia 8.8

CÓDIGO	(d)	L	○	ENVASE
02110300012Z	M3	12	ALLEN 2	500
02110300015Z	M3	15	ALLEN 2	1000
02110300020Z	M3	20	ALLEN 2	500
02110300025Z	M3	25	ALLEN 2	500
02110300030Z	M3	30	ALLEN 2	500
02110400010Z	M4	10	ALLEN 2,5	1000
02110400018Z	M4	18	ALLEN 2,5	500
02110400020Z	M4	20	ALLEN 2,5	500
02110400025Z	M4	25	ALLEN 2,5	500
02110400030Z	M4	30	ALLEN 2,5	500
02110400040Z	M4	40	ALLEN 2,5	500
02110500015Z	M5	15	ALLEN 3	1000
02110500020Z	M5	20	ALLEN 3	500
02110500035Z	M5	35	ALLEN 3	200
02110500045Z	M5	45	ALLEN 3	200
02110500050Z	M5	50	ALLEN 3	500
02110600010Z	M6	10	ALLEN 4	1000
02110600040Z	M6	40	ALLEN 4	200

CÓDIGO	(d)	L	○	ENVASE
02110600045Z	M6	45	ALLEN 4	200
02110600050Z	M6	50	ALLEN 4	200
02110600060Z	M6	60	ALLEN 4	200
02110600070Z	M6	70	ALLEN 4	200
02110600090Z	M6	90	ALLEN 4	200
02110800022Z	M8	22	ALLEN 5	500
02110800055Z	M8	55	ALLEN 5	200
02110800060Z	M8	60	ALLEN 5	200
02110800065Z	M8	65	ALLEN 5	200
02110800070Z	M8	70	ALLEN 5	200
02110800090Z	M8	90	ALLEN 5	100
02110800100Z	M8	100	ALLEN 5	100
02110800110Z	M8	110	ALLEN 5	100
02111000040Z	M10	40	ALLEN 6	100
02111000070Z	M10	70	ALLEN 6	100
02111000090Z	M10	90	ALLEN 6	100
02111000100Z	M10	100	ALLEN 6	100



0211 ISO 10642 (DIN 7991) CALIDAD 8.8

d	M3	M4	M5	M6	M8	M10
D	6	8	10	12	16	20
K	1,8	2,4	2,8	3,3	4,4	5,5
S	2	2,5	3	4	5	6

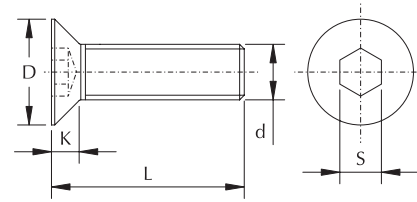

- Tornillo de cabeza avellanada y huella hexagonal.
- Alta Resistencia 8.8



CÓDIGO	(d)	L	○	ENVASE
02110300025P	M3	25	ALLEN 2	500
02110300030P	M3	30	ALLEN 2	500
02110400010P	M4	10	ALLEN 2,5	1000
02110400014P	M4	14	ALLEN 2,5	500
02110400015P	M4	15	ALLEN 2,5	1000
02110400020P	M4	20	ALLEN 2,5	500
02110400025P	M4	25	ALLEN 2,5	500
02110400040P	M4	40	ALLEN 2,5	500
02110500015P	M5	15	ALLEN 3	1000
02110500025P	M5	25	ALLEN 3	500
02110500035P	M5	35	ALLEN 3	200
02110500045P	M5	45	ALLEN 3	200
02110500050P	M5	50	ALLEN 3	200
02110600010P	M6	10	ALLEN 4	1000
02110600012P	M6	12	ALLEN 4	1000
02110600015P	M6	15	ALLEN 4	1000
02110600040P	M6	40	ALLEN 4	250
02110600045P	M6	45	ALLEN 4	200
02110600050P	M6	50	ALLEN 4	200

CÓDIGO	(d)	L	○	ENVASE
02110600070P	M6	70	ALLEN 4	200
02110600090P	M6	90	ALLEN 4	200
02110800015P	M8	15	ALLEN 5	200
02110800020P	M8	20	ALLEN 5	200
02110800040P	M8	40	ALLEN 5	200
02110800055P	M8	55	ALLEN 5	200
02110800060P	M8	60	ALLEN 5	200
02110800090P	M8	90	ALLEN 5	100
02111000020P	M10	20	ALLEN 6	200
02111000030P	M10	30	ALLEN 6	200
02111000035P	M10	35	ALLEN 6	100
02111000040P	M10	40	ALLEN 6	100
02111000045P	M10	45	ALLEN 6	100
02111000050P	M10	50	ALLEN 6	100
02111000060P	M10	60	ALLEN 6	100
02111000070P	M10	70	ALLEN 6	100
02111000090P	M10	90	ALLEN 6	100
02111000100P	M10	100	ALLEN 6	100

0212 ISO 10642 (DIN 7991) CALIDAD 10.9

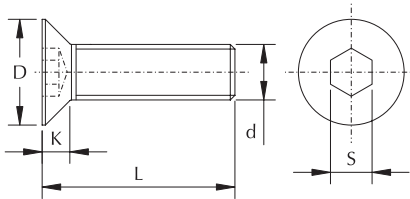

d	M3	M4	M5	M6	M8	M10
D	6	8	10	12	16	20
K	1,8	2,4	2,8	3,3	4,4	5,5
S	2	2,5	3	4	5	6



- Tornillo de cabeza avellanada y huella hexagonal.
- Alta Resistencia 10.9

CÓDIGO	(d)	L	○	ENVASE
02120300006Z	M3	6	ALLEN 2	1000
02120300008Z	M3	8	ALLEN 2	1000
02120300010Z	M3	10	ALLEN 2	1000
02120300012Z	M3	12	ALLEN 2	500
02120300014Z	M3	14	ALLEN 2	1000
02120300016Z	M3	16	ALLEN 2	1000
02120300018Z	M3	18	ALLEN 2	1000
02120300020Z	M3	20	ALLEN 2	1000
02120300025Z	M3	25	ALLEN 2	500
02120300030Z	M3	30	ALLEN 2	1000
02120400006Z	M4	6	ALLEN 2,5	1000
02120400008Z	M4	8	ALLEN 2,5	1000
02120400010Z	M4	10	ALLEN 2,5	1000
02120400012Z	M4	12	ALLEN 2,5	1000
02120400014Z	M4	14	ALLEN 2,5	500
02120400016Z	M4	16	ALLEN 2,5	1000
02120400020Z	M4	20	ALLEN 2,5	1000
02120400025Z	M4	25	ALLEN 2,5	1000
02120400030Z	M4	30	ALLEN 2,5	1000
02120400035Z	M4	35	ALLEN 2,5	1000
02120400040Z	M4	40	ALLEN 2,5	500
02120400045Z	M4	45	ALLEN 2,5	500
02120400050Z	M4	50	ALLEN 2,5	500
02120400055Z	M4	55	ALLEN 2,5	500
02120400060Z	M4	60	ALLEN 2,5	1000
02120500008Z	M5	8	ALLEN 3	500
02120500010Z	M5	10	ALLEN 3	500
02120500012Z	M5	12	ALLEN 3	500
02120500014Z	M5	14	ALLEN 3	500
02120500016Z	M5	16	ALLEN 3	500
02120500018Z	M5	18	ALLEN 3	500
02120500020Z	M5	20	ALLEN 3	1000
02120500025Z	M5	25	ALLEN 3	1000
02120500030Z	M5	30	ALLEN 3	1000
02120500035Z	M5	35	ALLEN 3	500
02120500040Z	M5	40	ALLEN 3	500
02120500045Z	M5	45	ALLEN 3	500
02120500050Z	M5	50	ALLEN 3	500
02120600008Z	M6	8	ALLEN 4	500
02120600010Z	M6	10	ALLEN 4	500
02120600012Z	M6	12	ALLEN 4	500
02120600014Z	M6	14	ALLEN 4	500
02120600016Z	M6	16	ALLEN 4	500
02120600018Z	M6	18	ALLEN 4	500
02120600020Z	M6	20	ALLEN 4	500

CÓDIGO	(d)	L	○	ENVASE
02120600022Z	M6	22	ALLEN 4	500
02120600025Z	M6	25	ALLEN 4	500
02120600030Z	M6	30	ALLEN 4	500
02120600035Z	M6	35	ALLEN 4	200
02120600040Z	M6	40	ALLEN 4	200
02120600045Z	M6	45	ALLEN 4	200
02120600050Z	M6	50	ALLEN 4	200
02120600055Z	M6	55	ALLEN 4	200
02120600060Z	M6	60	ALLEN 4	200
02120600070Z	M6	70	ALLEN 4	200
02120600080Z	M6	80	ALLEN 4	200
02120600090Z	M6	90	ALLEN 4	100
02120800010Z	M8	10	ALLEN 5	200
02120800012Z	M8	12	ALLEN 5	200
02120800016Z	M8	16	ALLEN 5	200
02120800018Z	M8	18	ALLEN 5	200
02120800020Z	M8	20	ALLEN 5	200
02120800022Z	M8	22	ALLEN 5	1500
02120800025Z	M8	25	ALLEN 5	200
02120800030Z	M8	30	ALLEN 5	200
02120800035Z	M8	35	ALLEN 5	200
02120800040Z	M8	40	ALLEN 5	200
02120800045Z	M8	45	ALLEN 5	100
02120800050Z	M8	50	ALLEN 5	100
02120800060Z	M8	60	ALLEN 5	100
02120800065Z	M8	65	ALLEN 5	100
02120800070Z	M8	70	ALLEN 5	100
02120800080Z	M8	80	ALLEN 5	100
02120800090Z	M8	90	ALLEN 5	100
02120800100Z	M8	100	ALLEN 5	100
02120800110Z	M8	110	ALLEN 5	100
02121000016Z	M10	16	ALLEN 6	200
02121000020Z	M10	20	ALLEN 6	200
02121000025Z	M10	25	ALLEN 6	200
02121000030Z	M10	30	ALLEN 6	200
02121000035Z	M10	35	ALLEN 6	100
02121000040Z	M10	40	ALLEN 6	100
02121000045Z	M10	45	ALLEN 6	100
02121000050Z	M10	50	ALLEN 6	100
02121000055Z	M10	55	ALLEN 6	100
02121000060Z	M10	60	ALLEN 6	100
02121000065Z	M10	65	ALLEN 6	100
02121000070Z	M10	70	ALLEN 6	100
02121000080Z	M10	80	ALLEN 6	100
02121000090Z	M10	90	ALLEN 6	100

Medidas en mm.



Puntas de atornillar disponibles en página 272.

d	M10	M12	M14	M16
D	20	24	27	30
K	5,5	6,5	7	7,5
S	6	8	10	10

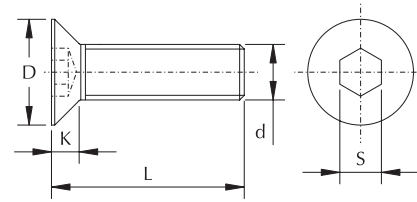

CÓDIGO	(d)	L	○	ENVASE
02121000100Z	M10	100	ALLEN 6	100
02121000110Z	M10	110	ALLEN 6	100
02121000120Z	M10	120	ALLEN 6	100
02121000130Z	M10	130	ALLEN 6	100
02121000140Z	M10	140	ALLEN 6	50
02121000150Z	M10	150	ALLEN 6	50
02121200020Z	M12	20	ALLEN 8	100
02121200025Z	M12	25	ALLEN 8	100
02121200030Z	M12	30	ALLEN 8	100
02121200035Z	M12	35	ALLEN 8	100
02121200040Z	M12	40	ALLEN 8	100
02121200045Z	M12	45	ALLEN 8	100
02121200050Z	M12	50	ALLEN 8	100
02121200055Z	M12	55	ALLEN 8	100
02121200060Z	M12	60	ALLEN 8	100
02121200065Z	M12	65	ALLEN 8	100
02121200070Z	M12	70	ALLEN 8	100
02121200080Z	M12	80	ALLEN 8	100
02121200090Z	M12	90	ALLEN 8	100

CÓDIGO	(d)	L	○	ENVASE
02121200100Z	M12	100	ALLEN 8	100
02121200110Z	M12	110	ALLEN 8	100
02121200120Z	M12	120	ALLEN 8	50
02121400020Z	M14	20	ALLEN 10	100
02121400025Z	M14	25	ALLEN 10	100
02121400030Z	M14	30	ALLEN 10	100
02121400035Z	M14	35	ALLEN 10	100
02121400040Z	M14	40	ALLEN 10	100
02121400045Z	M14	45	ALLEN 10	100
02121400050Z	M14	50	ALLEN 10	100
02121400055Z	M14	55	ALLEN 10	100
02121400060Z	M14	60	ALLEN 10	50
02121400070Z	M14	70	ALLEN 10	50
02121400080Z	M14	80	ALLEN 10	50
02121400090Z	M14	90	ALLEN 10	50
02121400100Z	M14	100	ALLEN 10	50
02121400110Z	M14	110	ALLEN 10	50
02121400120Z	M14	120	ALLEN 10	50
02121600080Z	M16	80	ALLEN 10	50

Consultar disponibilidad en otras medidas.

0212 ISO 10642 (DIN 7991) CALIDAD 10.9

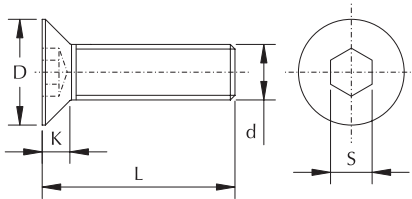

d	M3	M4	M5	M6	M8	M10
D	6	8	10	12	16	20
K	1,8	2,4	2,8	3,3	4,4	5,5
S	2	2,5	3	4	5	6



- Tornillo de cabeza avellanada y huella hexagonal.
- Alta Resistencia 10.9

CÓDIGO	(d)	L	○	ENVASE
02120300006P	M3	6	ALLEN 2	1000
02120300008P	M3	8	ALLEN 2	1000
02120300010P	M3	10	ALLEN 2	1000
02120300012P	M3	12	ALLEN 2	500
02120300014P	M3	14	ALLEN 2	1000
02120300016P	M3	16	ALLEN 2	1000
02120300018P	M3	18	ALLEN 2	1000
02120300020P	M3	20	ALLEN 2	1000
02120300025P	M3	25	ALLEN 2	500
02120300030P	M3	30	ALLEN 2	500
02120400006P	M4	6	ALLEN 2,5	1000
02120400008P	M4	8	ALLEN 2,5	1000
02120400010P	M4	10	ALLEN 2,5	500
02120400012P	M4	12	ALLEN 2,5	500
02120400014P	M4	14	ALLEN 2,5	500
02120400016P	M4	16	ALLEN 2,5	500
02120400020P	M4	20	ALLEN 2,5	500
02120400025P	M4	25	ALLEN 2,5	500
02120400030P	M4	30	ALLEN 2,5	1000
02120400035P	M4	35	ALLEN 2,5	1000
02120400040P	M4	40	ALLEN 2,5	500
02120400045P	M4	45	ALLEN 2,5	1000
02120400050P	M4	50	ALLEN 2,5	500
02120400055P	M4	55	ALLEN 2,5	500
02120400060P	M4	60	ALLEN 2,5	1000
02120500008P	M5	8	ALLEN 3	500
02120500010P	M5	10	ALLEN 3	1000
02120500012P	M5	12	ALLEN 3	1000
02120500014P	M5	14	ALLEN 3	500
02120500016P	M5	16	ALLEN 3	500
02120500020P	M5	20	ALLEN 3	500
02120500025P	M5	25	ALLEN 3	500
02120500030P	M5	30	ALLEN 3	1000
02120500035P	M5	35	ALLEN 3	500
02120500040P	M5	40	ALLEN 3	500
02120500045P	M5	45	ALLEN 3	500
02120500050P	M5	50	ALLEN 3	500
02120600008P	M6	8	ALLEN 4	500
02120600010P	M6	10	ALLEN 4	500
02120600012P	M6	12	ALLEN 4	500
02120600014P	M6	14	ALLEN 4	500
02120600016P	M6	16	ALLEN 4	500
02120600020P	M6	20	ALLEN 4	500
02120600022P	M6	22	ALLEN 4	500
02120600025P	M6	25	ALLEN 4	200

CÓDIGO	(d)	L	○	ENVASE
02120600030P	M6	30	ALLEN 4	200
02120600035P	M6	35	ALLEN 4	200
02120600040P	M6	40	ALLEN 4	200
02120600045P	M6	45	ALLEN 4	200
02120600050P	M6	50	ALLEN 4	200
02120600055P	M6	55	ALLEN 4	200
02120600060P	M6	60	ALLEN 4	200
02120600080P	M6	80	ALLEN 4	200
02120800014P	M8	14	ALLEN 5	200
02120800016P	M8	16	ALLEN 5	200
02120800020P	M8	20	ALLEN 5	200
02120800025P	M8	25	ALLEN 5	200
02120800030P	M8	30	ALLEN 5	200
02120800035P	M8	35	ALLEN 5	100
02120800040P	M8	40	ALLEN 5	100
02120800045P	M8	45	ALLEN 5	200
02120800050P	M8	50	ALLEN 5	100
02120800060P	M8	60	ALLEN 5	100
02120800070P	M8	70	ALLEN 5	100
02120800080P	M8	80	ALLEN 5	100
02120800100P	M8	100	ALLEN 5	100
02121000020P	M10	20	ALLEN 6	100
02121000025P	M10	25	ALLEN 6	100
02121000030P	M10	30	ALLEN 6	100
02121000040P	M10	40	ALLEN 6	100
02121000045P	M10	45	ALLEN 6	100
02121000050P	M10	50	ALLEN 6	100
02121000055P	M10	55	ALLEN 6	100
02121000060P	M10	60	ALLEN 6	100
02121000065P	M10	65	ALLEN 6	100
02121000070P	M10	70	ALLEN 6	100
02121000075P	M10	75	ALLEN 6	100
02121000080P	M10	80	ALLEN 6	100
02121000090P	M10	90	ALLEN 6	100
02121000100P	M10	100	ALLEN 6	100
02121000110P	M10	110	ALLEN 6	100
02121000120P	M10	120	ALLEN 6	100
02121000125P	M10	125	ALLEN 6	25
02121000130P	M10	130	ALLEN 6	100
02121000140P	M10	140	ALLEN 6	50
02121200020P	M12	20	ALLEN 8	100
02121200025P	M12	25	ALLEN 8	100
02121200030P	M12	30	ALLEN 8	100
02121200035P	M12	35	ALLEN 8	100
02121200040P	M12	40	ALLEN 8	100

Medidas en mm.



Puntas de atornillar disponibles en página 272.

d	M10	M12	M14
D	20	24	27
K	5,5	6,5	7
S	6	8	10

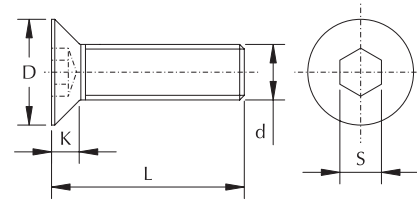

CÓDIGO	(d)	L	○	ENVASE
02121200045P	M12	45	ALLEN 8	100
02121200050P	M12	50	ALLEN 8	100
02121200055P	M12	55	ALLEN 8	100
02121200060P	M12	60	ALLEN 8	100
02121200065P	M12	65	ALLEN 8	100
02121200070P	M12	70	ALLEN 8	100
02121200080P	M12	80	ALLEN 8	100
02121200090P	M12	90	ALLEN 8	100
02121200100P	M12	100	ALLEN 8	100
02121200110P	M12	110	ALLEN 8	100
02121200120P	M12	120	ALLEN 8	50
02121200130P	M12	130	ALLEN 8	50
02121200140P	M12	140	ALLEN 8	50
02121400020P	M14	20	ALLEN 10	100
02121400025P	M14	25	ALLEN 10	100

CÓDIGO	(d)	L	○	ENVASE
02121400030P	M14	30	ALLEN 10	100
02121400035P	M14	35	ALLEN 10	100
02121400040P	M14	40	ALLEN 10	100
02121400045P	M14	45	ALLEN 10	100
02121400050P	M14	50	ALLEN 10	100
02121400055P	M14	55	ALLEN 10	100
02121400060P	M14	60	ALLEN 10	50
02121400065P	M14	65	ALLEN 10	50
02121400070P	M14	70	ALLEN 10	50
02121400080P	M14	80	ALLEN 10	50
02121400090P	M14	90	ALLEN 10	50
02121400100P	M14	100	ALLEN 10	50
02121400110P	M14	110	ALLEN 10	50
02121400120P	M14	120	ALLEN 10	50
02121400130P	M14	130	ALLEN 10	50

Consultar disponibilidad en otras medidas.

0213 ISO 7380 CALIDAD 10.9

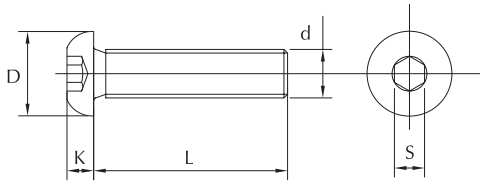

d	M3	M4	M5	M6	M8	M10
D	5,7	7,6	9,5	10,5	14	17,5
K	1,6	2,2	2,75	3,3	4,4	5,5
S	2	2,5	3	4	5	6



- Tornillo de cabeza redonda y huella hexagonal.
- Alta Resistencia 10.9

CÓDIGO	(d)	L	○	ENVASE
02130300010Z	M3	10	ALLEN 2	1000
02130300012Z	M3	12	ALLEN 2	1000
02130300014Z	M3	14	ALLEN 2	1000
02130300016Z	M3	16	ALLEN 2	1000
02130300020Z	M3	20	ALLEN 2	1000
02130300025Z	M3	25	ALLEN 2	1000
02130300030Z	M3	30	ALLEN 2	1000
02130300035Z	M3	35	ALLEN 2	1000
02130300040Z	M3	40	ALLEN 2	1000
02130400008Z	M4	8	ALLEN 2,5	1000
02130400010Z	M4	10	ALLEN 2,5	1000
02130400012Z	M4	12	ALLEN 2,5	1000
02130400014Z	M4	14	ALLEN 2,5	1000
02130400016Z	M4	16	ALLEN 2,5	1000
02130400020Z	M4	20	ALLEN 2,5	1000
02130400025Z	M4	25	ALLEN 2,5	1000
02130400030Z	M4	30	ALLEN 2,5	1000
02130400035Z	M4	35	ALLEN 2,5	1000
02130400040Z	M4	40	ALLEN 2,5	1000
02130500010Z	M5	10	ALLEN 3	1000
02130500012Z	M5	12	ALLEN 3	1000
02130500014Z	M5	14	ALLEN 3	1000
02130500016Z	M5	16	ALLEN 3	1000
02130500020Z	M5	20	ALLEN 3	1000
02130500025Z	M5	25	ALLEN 3	500
02130500030Z	M5	30	ALLEN 3	1000
02130500035Z	M5	35	ALLEN 3	1000
02130500040Z	M5	40	ALLEN 3	500
02130500045Z	M5	45	ALLEN 3	500
02130500050Z	M5	50	ALLEN 3	500
02130600008Z	M6	8	ALLEN 4	500
02130600010Z	M6	10	ALLEN 4	500
02130600012Z	M6	12	ALLEN 4	500

CÓDIGO	(d)	L	○	ENVASE
02130600014Z	M6	14	ALLEN 4	500
02130600016Z	M6	16	ALLEN 4	500
02130600020Z	M6	20	ALLEN 4	500
02130600025Z	M6	25	ALLEN 4	500
02130600030Z	M6	30	ALLEN 4	200
02130600035Z	M6	35	ALLEN 4	200
02130600040Z	M6	40	ALLEN 4	200
02130600045Z	M6	45	ALLEN 4	200
02130600050Z	M6	50	ALLEN 4	200
02130600060Z	M6	60	ALLEN 4	200
02130800010Z	M8	10	ALLEN 5	200
02130800012Z	M8	12	ALLEN 5	200
02130800014Z	M8	14	ALLEN 5	200
02130800016Z	M8	16	ALLEN 5	200
02130800020Z	M8	20	ALLEN 5	200
02130800025Z	M8	25	ALLEN 5	200
02130800030Z	M8	30	ALLEN 5	200
02130800035Z	M8	35	ALLEN 5	200
02130800040Z	M8	40	ALLEN 5	100
02130800045Z	M8	45	ALLEN 5	100
02130800050Z	M8	50	ALLEN 5	100
02130800055Z	M8	55	ALLEN 5	100
02130800060Z	M8	60	ALLEN 5	100
02131000016Z	M10	16	ALLEN 6	100
02131000020Z	M10	20	ALLEN 6	100
02131000025Z	M10	25	ALLEN 6	100
02131000030Z	M10	30	ALLEN 6	100
02131000035Z	M10	35	ALLEN 6	100
02131000040Z	M10	40	ALLEN 6	100
02131000045Z	M10	45	ALLEN 6	100
02131000050Z	M10	50	ALLEN 6	100
02131000060Z	M10	60	ALLEN 6	100

Consultar disponibilidad en otras medidas.

0213 ISO 7380 CALIDAD 10.9

d	M3	M4	M5	M6	M8	M10
D	5,7	7,6	9,5	10,5	14	17,5
K	1,6	2,2	2,75	3,3	4,4	5,5
S	2	2,5	3	4	5	6

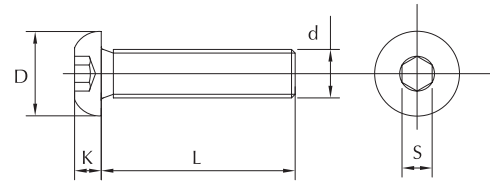

- Tornillo de cabeza redonda y huella hexagonal.
- Alta Resistencia 10.9



CÓDIGO	(d)	L	○	ENVASE
02130300010P	M3	10	ALLEN 2	1000
02130300012P	M3	12	ALLEN 2	1000
02130300014P	M3	14	ALLEN 2	1000
02130300016P	M3	16	ALLEN 2	1000
02130300020P	M3	20	ALLEN 2	1000
02130300025P	M3	25	ALLEN 2	1000
02130300030P	M3	30	ALLEN 2	1000
02130300035P	M3	35	ALLEN 2	1000
02130300040P	M3	40	ALLEN 2	1000
02130400008P	M4	8	ALLEN 2,5	1000
02130400010P	M4	10	ALLEN 2,5	1000
02130400012P	M4	12	ALLEN 2,5	1000
02130400014P	M4	14	ALLEN 2,5	1000
02130400016P	M4	16	ALLEN 2,5	1000
02130400020P	M4	20	ALLEN 2,5	1000
02130400025P	M4	25	ALLEN 2,5	1000
02130400030P	M4	30	ALLEN 2,5	1000
02130400035P	M4	35	ALLEN 2,5	1000
02130400040P	M4	40	ALLEN 2,5	1000
02130500010P	M5	10	ALLEN 3	1000
02130500012P	M5	12	ALLEN 3	1000
02130500014P	M5	14	ALLEN 3	1000
02130500016P	M5	16	ALLEN 3	1000
02130500020P	M5	20	ALLEN 3	500
02130500025P	M5	25	ALLEN 3	500
02130500030P	M5	30	ALLEN 3	500
02130500035P	M5	35	ALLEN 3	500
02130500040P	M5	40	ALLEN 3	500
02130500045P	M5	45	ALLEN 3	500
02130500050P	M5	50	ALLEN 3	500
02130600010P	M6	10	ALLEN 4	500
02130600012P	M6	12	ALLEN 4	500

CÓDIGO	(d)	L	○	ENVASE
02130600014P	M6	14	ALLEN 4	500
02130600016P	M6	16	ALLEN 4	500
02130600020P	M6	20	ALLEN 4	500
02130600025P	M6	25	ALLEN 4	500
02130600030P	M6	30	ALLEN 4	500
02130600035P	M6	35	ALLEN 4	200
02130600040P	M6	40	ALLEN 4	200
02130600045P	M6	45	ALLEN 4	200
02130600050P	M6	50	ALLEN 4	200
02130600060P	M6	60	ALLEN 4	200
02130800010P	M8	10	ALLEN 5	500
02130800012P	M8	12	ALLEN 5	500
02130800014P	M8	14	ALLEN 5	200
02130800016P	M8	16	ALLEN 5	200
02130800020P	M8	20	ALLEN 5	200
02130800025P	M8	25	ALLEN 5	200
02130800030P	M8	30	ALLEN 5	200
02130800035P	M8	35	ALLEN 5	200
02130800040P	M8	40	ALLEN 5	200
02130800045P	M8	45	ALLEN 5	100
02130800050P	M8	50	ALLEN 5	100
02130800060P	M8	60	ALLEN 5	100
02131000016P	M10	16	ALLEN 6	100
02131000020P	M10	20	ALLEN 6	100
02131000025P	M10	25	ALLEN 6	100
02131000030P	M10	30	ALLEN 6	100
02131000035P	M10	35	ALLEN 6	100
02131000040P	M10	40	ALLEN 6	100
02131000045P	M10	45	ALLEN 6	100
02131000050P	M10	50	ALLEN 6	100
02131000060P	M10	60	ALLEN 6	100

Consultar disponibilidad en otras medidas.

0214 ISO 7380-2 CON ARANDELA CALIDAD 10.9

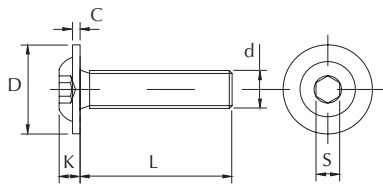

d	M6	M8	M10
D	13,6	17,8	21,9
K	3,3	4,4	5,5
S	4	5	6
C	1,1	1,3	1,7



- Tornillo de cabeza redonda con arandela estampada y huella hexagonal.
- Alta Resistencia 10.9

CÓDIGO	(d)	L	○	ENVASE
02140600010Z	M6	10	ALLEN 4	1000
02140600012Z	M6	12	ALLEN 4	1000
02140600014Z	M6	14	ALLEN 4	1000
02140600016Z	M6	16	ALLEN 4	1000
02140600018Z	M6	18	ALLEN 4	1000
02140600020Z	M6	20	ALLEN 4	1000
02140600025Z	M6	25	ALLEN 4	500
02140600030Z	M6	30	ALLEN 4	500
02140600035Z	M6	35	ALLEN 4	500
02140600040Z	M6	40	ALLEN 4	200
02140600045Z	M6	45	ALLEN 4	200
02140600050Z	M6	50	ALLEN 4	200
02140800012Z	M8	12	ALLEN 5	500
02140800014Z	M8	14	ALLEN 5	500
02140800016Z	M8	16	ALLEN 5	500
02140800018Z	M8	18	ALLEN 5	500

CÓDIGO	(d)	L	○	ENVASE
02140800020Z	M8	20	ALLEN 5	500
02140800022Z	M8	22	ALLEN 5	200
02140800025Z	M8	25	ALLEN 5	200
02140800030Z	M8	30	ALLEN 5	200
02140800035Z	M8	35	ALLEN 5	200
02140800040Z	M8	40	ALLEN 5	200
02140800045Z	M8	45	ALLEN 5	200
02140800050Z	M8	50	ALLEN 5	200
02141000020Z	M10	20	ALLEN 6	200
02141000025Z	M10	25	ALLEN 6	200
02141000030Z	M10	30	ALLEN 6	200
02141000035Z	M10	35	ALLEN 6	200
02141000040Z	M10	40	ALLEN 6	200
02141000045Z	M10	45	ALLEN 6	100
02141000050Z	M10	50	ALLEN 6	100

Consultar disponibilidad en otras medidas.  
Consultar cantidad mínima de servicio.



CÓDIGO	(d)	L	○	ENVASE
02140500025P	M5	25	ALLEN 3	100
02140600010P	M6	10	ALLEN 4	1000
02140600012P	M6	12	ALLEN 4	1000
02140600014P	M6	14	ALLEN 4	1000
02140600016P	M6	16	ALLEN 4	1000
02140600018P	M6	18	ALLEN 4	1000
02140600020P	M6	20	ALLEN 4	1000
02140600025P	M6	25	ALLEN 4	500
02140600030P	M6	30	ALLEN 4	500
02140600035P	M6	35	ALLEN 4	500
02140600040P	M6	40	ALLEN 4	200
02140600045P	M6	45	ALLEN 4	200
02140600050P	M6	50	ALLEN 4	200
02140800012P	M8	12	ALLEN 5	500
02140800014P	M8	14	ALLEN 5	500
02140800016P	M8	16	ALLEN 5	500

CÓDIGO	(d)	L	○	ENVASE
02140800018P	M8	18	ALLEN 5	500
02140800020P	M8	20	ALLEN 5	500
02140800022P	M8	22	ALLEN 5	200
02140800025P	M8	25	ALLEN 5	200
02140800030P	M8	30	ALLEN 5	200
02140800035P	M8	35	ALLEN 5	200
02140800040P	M8	40	ALLEN 5	200
02140800045P	M8	45	ALLEN 5	200
02140800050P	M8	50	ALLEN 5	200
02141000020P	M10	20	ALLEN 6	200
02141000025P	M10	25	ALLEN 6	200
02141000030P	M10	30	ALLEN 6	200
02141000035P	M10	35	ALLEN 6	200
02141000040P	M10	40	ALLEN 6	200
02141000045P	M10	45	ALLEN 6	100
02141000050P	M10	50	ALLEN 6	100

Consultar disponibilidad en otras medidas.  
Consultar cantidad mínima de servicio.

Medidas en mm.

Puntas de atornillar disponibles en página 272.



0279 TORNILLO ALLEN SETA ESTRIADO CALIDAD 10.9

d	M6
D	14
K	4
S	5

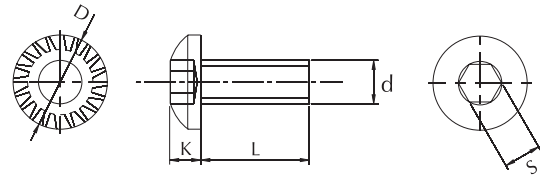

- Tornillo de cabeza redonda y huella hexagonal.
- Las estrías realizan la función de freno sobre la superficie a fijar.
- Alta resistencia 10.9



CÓDIGO	(d)	L	○	ENVASE
02790600007Z	M6	7,5	ALLEN 5	4000
02790600010Z	M6	10	ALLEN 5	3000
02790600013Z	M6	13	ALLEN 5	3000
02790600015Z	M6	15	ALLEN 5	2000
02790600020Z	M6	20	ALLEN 5	2000
02790600025Z	M6	25	ALLEN 5	2000

CÓDIGO	(d)	L	○	ENVASE
02790600030Z	M6	30	ALLEN 5	2000
02790600035Z	M6	35	ALLEN 5	1500
02790600040Z	M6	40	ALLEN 5	2200
02790600050Z	M6	50	ALLEN 5	1000
02790600060Z	M6	60	ALLEN 5	1000

Consultar disponibilidad en otras medidas.



CÓDIGO	(d)	L	○	ENVASE
02790600010N	M6	10	ALLEN 5	3000
02790600013N	M6	13	ALLEN 5	3000
02790600015N	M6	15	ALLEN 5	2000

CÓDIGO	(d)	L	○	ENVASE
02790600020N	M6	20	ALLEN 5	2000
02790600025N	M6	25	ALLEN 5	2000

Consultar disponibilidad en otras medidas.

0215 TORNILLO ALLEN SETA ESTRIADO PERFIL ALTO CALIDAD 8.8

d	M6
D	14
K	6
S	5

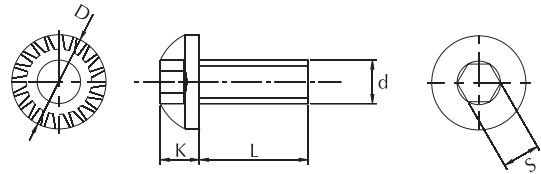

- Tornillo de cabeza redonda y huella hexagonal.
- Las estrías realizan la función de freno sobre la superficie a fijar.
- El perfil alto viene de una mayor altura de la cabeza con respecto a su homónimo de perfil bajo.
- Alta resistencia 8.8



CÓDIGO	(d)	L	○	ENVASE
02150600007Z	M6	7,5	ALLEN 5	500
02150600018Z	M6	18	ALLEN 5	500
02150600020Z	M6	20	ALLEN 5	250
02150600030Z	M6	30	ALLEN 5	200
02150600035Z	M6	35	ALLEN 5	200

CÓDIGO	(d)	L	○	ENVASE
02150600045Z	M6	45	ALLEN 5	200
02150600050Z	M6	50	ALLEN 5	200
02150600060Z	M6	60	ALLEN 5	200
02150600075Z	M6	75	ALLEN 5	200
02150600085Z	M6	85	ALLEN 5	200

Consultar disponibilidad en otras medidas.

0217 DIN 913

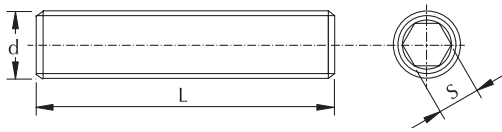

d	M3	M4	M5	M6	M8	M10	M12
S	1,5	2	2,5	3	4	5	6



- Espárrago con huella hexagonal sin punta.

CÓDIGO	(d)	L	○	ENVASE
02170300003P	M3	3	ALLEN 1,5	1000
02170300004P	M3	4	ALLEN 1,5	1000
02170300005P	M3	5	ALLEN 1,5	1000
02170300006P	M3	6	ALLEN 1,5	1000
02170300008P	M3	8	ALLEN 1,5	1000
02170300010P	M3	10	ALLEN 1,5	1000
02170300012P	M3	12	ALLEN 1,5	1000
02170300016P	M3	16	ALLEN 1,5	1000
02170300020P	M3	20	ALLEN 1,5	1000
02170300025P	M3	25	ALLEN 1,5	500
02170300030P	M3	30	ALLEN 1,5	500
02170400003P	M4	3	ALLEN 2	1000
02170400004P	M4	4	ALLEN 2	1000
02170400005P	M4	5	ALLEN 2	1000
02170400006P	M4	6	ALLEN 2	1000
02170400008P	M4	8	ALLEN 2	1000
02170400010P	M4	10	ALLEN 2	1000
02170400012P	M4	12	ALLEN 2	1000
02170400016P	M4	16	ALLEN 2	1000
02170400018P	M4	18	ALLEN 2	1000
02170400020P	M4	20	ALLEN 2	1000
02170400025P	M4	25	ALLEN 2	500
02170400030P	M4	30	ALLEN 2	500
02170400035P	M4	35	ALLEN 2	500
02170400040P	M4	40	ALLEN 2	500
02170500004P	M5	4	ALLEN 2,5	1000
02170500005P	M5	5	ALLEN 2,5	1000
02170500006P	M5	6	ALLEN 2,5	1000
02170500008P	M5	8	ALLEN 2,5	1000
02170500010P	M5	10	ALLEN 2,5	1000
02170500012P	M5	12	ALLEN 2,5	1000
02170500014P	M5	14	ALLEN 2,5	1000
02170500016P	M5	16	ALLEN 2,5	1000
02170500020P	M5	20	ALLEN 2,5	500
02170500025P	M5	25	ALLEN 2,5	1000
02170500030P	M5	30	ALLEN 2,5	1000
02170500035P	M5	35	ALLEN 2,5	1000
02170500040P	M5	40	ALLEN 2,5	500
02170600005P	M6	5	ALLEN 3	1000
02170600006P	M6	6	ALLEN 3	1000
02170600008P	M6	8	ALLEN 3	1000
02170600010P	M6	10	ALLEN 3	1000
02170600012P	M6	12	ALLEN 3	500
02170600014P	M6	14	ALLEN 3	1000
02170600016P	M6	16	ALLEN 3	500
02170600020P	M6	20	ALLEN 3	500
02170600025P	M6	25	ALLEN 3	500
02170600030P	M6	30	ALLEN 3	500
02170600035P	M6	35	ALLEN 3	500

CÓDIGO	(d)	L	○	ENVASE
02170600040P	M6	40	ALLEN 3	500
02170600045P	M6	45	ALLEN 3	250
02170600050P	M6	50	ALLEN 3	500
02170600055P	M6	55	ALLEN 3	250
02170600060P	M6	60	ALLEN 3	300
02170800006P	M8	6	ALLEN 4	500
02170800008P	M8	8	ALLEN 4	1000
02170800010P	M8	10	ALLEN 4	1000
02170800012P	M8	12	ALLEN 4	200
02170800014P	M8	14	ALLEN 4	200
02170800016P	M8	16	ALLEN 4	200
02170800020P	M8	20	ALLEN 4	200
02170800025P	M8	25	ALLEN 4	200
02170800030P	M8	30	ALLEN 4	500
02170800035P	M8	35	ALLEN 4	200
02170800040P	M8	40	ALLEN 4	250
02170800045P	M8	45	ALLEN 4	200
02170800050P	M8	50	ALLEN 4	200
02170800055P	M8	55	ALLEN 4	200
02170800060P	M8	60	ALLEN 4	200
02170800070P	M8	70	ALLEN 4	200
02171000010P	M10	10	ALLEN 5	200
02171000012P	M10	12	ALLEN 5	200
02171000014P	M10	14	ALLEN 5	1000
02171000016P	M10	16	ALLEN 5	500
02171000020P	M10	20	ALLEN 5	200
02171000025P	M10	25	ALLEN 5	200
02171000030P	M10	30	ALLEN 5	200
02171000035P	M10	35	ALLEN 5	200
02171000040P	M10	40	ALLEN 5	200
02171000045P	M10	45	ALLEN 5	200
02171000050P	M10	50	ALLEN 5	200
02171000055P	M10	55	ALLEN 5	200
02171000060P	M10	60	ALLEN 5	100
02171000070P	M10	70	ALLEN 5	100
02171000080P	M10	80	ALLEN 5	100
02171200010P	M12	10	ALLEN 6	500
02171200012P	M12	12	ALLEN 6	500
02171200014P	M12	14	ALLEN 6	250
02171200016P	M12	16	ALLEN 6	200
02171200020P	M12	20	ALLEN 6	250
02171200025P	M12	25	ALLEN 6	200
02171200030P	M12	30	ALLEN 6	200
02171200035P	M12	35	ALLEN 6	200
02171200040P	M12	40	ALLEN 6	200
02171200050P	M12	50	ALLEN 6	100
02171200055P	M12	55	ALLEN 6	100
02171200060P	M12	60	ALLEN 6	100
02171200070P	M12	70	ALLEN 6	100

Medidas en mm.



Puntas de atornillar disponibles en página 272.

0218 DIN 914

d	M3	M4	M5	M6	M8	M10	M12
S	1,5	2	2,5	3	4	5	6

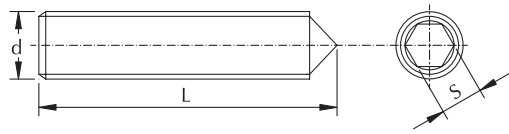

- Espárrago con huella hexagonal con punta.



CÓDIGO	(d)	L	○	ENVASE
02180300004P	M3	4	ALLEN 1,5	1000
02180300005P	M3	5	ALLEN 1,5	1000
02180300006P	M3	6	ALLEN 1,5	1000
02180300008P	M3	8	ALLEN 1,5	1000
02180300010P	M3	10	ALLEN 1,5	1000
02180300012P	M3	12	ALLEN 1,5	1000
02180400004P	M4	4	ALLEN 2	1000
02180400005P	M4	5	ALLEN 2	1000
02180400006P	M4	6	ALLEN 2	1000
02180400008P	M4	8	ALLEN 2	1000
02180400010P	M4	10	ALLEN 2	1000
02180400012P	M4	12	ALLEN 2	1000
02180400020P	M4	20	ALLEN 2	500
02180500005P	M5	5	ALLEN 2,5	1000
02180500006P	M5	6	ALLEN 2,5	1000
02180500008P	M5	8	ALLEN 2,5	1000
02180500010P	M5	10	ALLEN 2,5	1000
02180500012P	M5	12	ALLEN 2,5	1000
02180500016P	M5	16	ALLEN 2,5	1000
02180500020P	M5	20	ALLEN 2,5	1000
02180500025P	M5	25	ALLEN 2,5	500
02180500030P	M5	30	ALLEN 2,5	500
02180500035P	M5	35	ALLEN 2,5	500
02180500040P	M5	40	ALLEN 2,5	500
02180500050P	M5	50	ALLEN 2,5	500
02180600005P	M6	5	ALLEN 3	1000
02180600006P	M6	6	ALLEN 3	1000
02180600008P	M6	8	ALLEN 3	1000
02180600010P	M6	10	ALLEN 3	1000
02180600012P	M6	12	ALLEN 3	1000
02180600016P	M6	16	ALLEN 3	1000
02180600020P	M6	20	ALLEN 3	1000
02180600025P	M6	25	ALLEN 3	1000

CÓDIGO	(d)	L	○	ENVASE
02180600030P	M6	30	ALLEN 3	1000
02180600035P	M6	35	ALLEN 3	500
02180600040P	M6	40	ALLEN 3	200
02180600050P	M6	50	ALLEN 3	250
02180800008P	M8	8	ALLEN 4	1000
02180800010P	M8	10	ALLEN 4	1000
02180800012P	M8	12	ALLEN 4	500
02180800016P	M8	16	ALLEN 4	500
02180800020P	M8	20	ALLEN 4	500
02180800025P	M8	25	ALLEN 4	500
02180800030P	M8	30	ALLEN 4	500
02180800035P	M8	35	ALLEN 4	200
02180800040P	M8	40	ALLEN 4	250
02180800050P	M8	50	ALLEN 4	250
02181000010P	M10	10	ALLEN 5	500
02181000012P	M10	12	ALLEN 5	500
02181000016P	M10	16	ALLEN 5	500
02181000020P	M10	20	ALLEN 5	500
02181000025P	M10	25	ALLEN 5	200
02181000030P	M10	30	ALLEN 5	200
02181000035P	M10	35	ALLEN 5	200
02181000040P	M10	40	ALLEN 5	200
02181000050P	M10	50	ALLEN 5	200
02181000060P	M10	60	ALLEN 5	100
02181200012P	M12	12	ALLEN 6	500
02181200016P	M12	16	ALLEN 6	250
02181200020P	M12	20	ALLEN 6	250
02181200025P	M12	25	ALLEN 6	200
02181200030P	M12	30	ALLEN 6	200
02181200035P	M12	35	ALLEN 6	200
02181200040P	M12	40	ALLEN 6	200
02181200050P	M12	50	ALLEN 6	100

0219 VARILLA ROSCADA 1m.

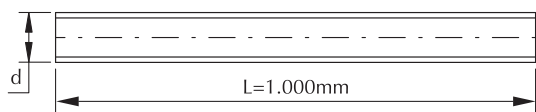

- Varilla roscada baja resistencia.
- Montaje en todo tipo de instalaciones eléctricas, de fontanería, suspensión de techos falsos, conductos de todo tipo y construcción en general.

CÓDIGO	(d)	L	ENVASE
02190301000Z	M3	1000	100
02190401000Z	M4	1000	100
02190501000Z	M5	1000	100
02190601000Z	M6	1000	100
02190801000Z	M8	1000	25
02191001000Z	M10	1000	25
02191201000Z	M12	1000	20
02191401000Z	M14	1000	10
02191601000Z	M16	1000	10
02191801000Z	M18	1000	10

CÓDIGO	(d)	L	ENVASE
02192001000Z	M20	1000	5
02192201000Z	M22	1000	5
02192401000Z	M24	1000	5
02192701000Z	M27	1000	5
02193001000Z	M30	1000	5
02193301000Z	M33	1000	3
02193601000Z	M36	1000	1
02193901000Z	M39	1000	1
02190141000Z	1/4"	1000	25

Consultar disponibilidad en otras medidas.

0220 VARILLA ROSCADA 1m. 8.8

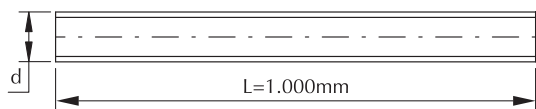

- Varilla roscada de calidad alta resistencia 8.8.
- Montaje en todo tipo de instalaciones eléctricas, de fontanería, suspensión de techos falsos, conductos de todo tipo y construcción en general.

CÓDIGO	(d)	L	ENVASE
02200801000Z	M8	1000	25
02201001000Z	M10	1000	25
02201201000Z	M12	1000	20
02201401000Z	M14	1000	10
02201601000Z	M16	1000	10
02201801000Z	M18	1000	10

CÓDIGO	(d)	L	ENVASE
02202001000Z	M20	1000	5
02202201000Z	M22	1000	5
02202401000Z	M24	1000	5
02202701000Z	M27	1000	5
02203001000Z	M30	1000	5
02203301000Z	M33	1000	1

Consultar disponibilidad en otras medidas.



CÓDIGO	(d)	L	ENVASE
02200801000P	M8	1000	25
02201001000P	M10	1000	25
02201201000P	M12	1000	20
02201401000P	M14	1000	10
02201601000P	M16	1000	10
02201801000P	M18	1000	10

CÓDIGO	(d)	L	ENVASE
02202001000P	M20	1000	5
02202201000P	M22	1000	5
02202401000P	M24	1000	5
02202701000P	M27	1000	5
02203001000P	M30	1000	1

Consultar disponibilidad en otras medidas.

Medidas en mm.



# VARILLA ROSCADA

- Desde M3 hasta M39.
- Diferentes longitudes: 1m, 2m y 3m.
- Calidad 8.8, 10.9 y baja resistencia.
- También disponible en acero inoxidable.

**Ofrecemos corte a medida.**

Consúltenos enviando un correo a:

[comercial@matriu.es](mailto:comercial@matriu.es)

o contacte con su comercial más cercano.

0221 VARILLA ROSCADA

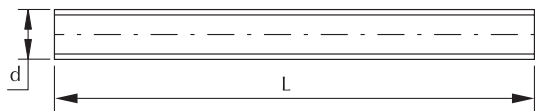

- Espárrago de rosca métrica.

CÓDIGO	(d)	L	ENVASE
02210400010Z	M4	10	1000
02210400015Z	M4	15	1000
02210400020Z	M4	20	1000
02210400025Z	M4	25	1000
02210400030Z	M4	30	1000
02210400035Z	M4	35	500
02210400040Z	M4	40	1000
02210400045Z	M4	45	500
02210400050Z	M4	50	1000
02210500010Z	M5	10	1000
02210500015Z	M5	15	1000
02210500020Z	M5	20	1000
02210500025Z	M5	25	500
02210500030Z	M5	30	500
02210500035Z	M5	35	500
02210500040Z	M5	40	500
02210500045Z	M5	45	500
02210500050Z	M5	50	500
02210500080Z	M5	80	500
02210600010Z	M6	10	1000
02210600015Z	M6	15	1000
02210600020Z	M6	20	500
02210600025Z	M6	25	500
02210600030Z	M6	30	500
02210600035Z	M6	35	500
02210600040Z	M6	40	250
02210600045Z	M6	45	250
02210600050Z	M6	50	250
02210600060Z	M6	60	250
02210600065Z	M6	65	250
02210600070Z	M6	70	200
02210600075Z	M6	75	200
02210600080Z	M6	80	200
02210600090Z	M6	90	200
02210600095Z	M6	95	200
02210600100Z	M6	100	250

CÓDIGO	(d)	L	ENVASE
02210600110Z	M6	110	100
02210600115Z	M6	115	150
02210600120Z	M6	120	100
02210600160Z	M6	160	100
02210800015Z	M8	15	500
02210800020Z	M8	20	500
02210800025Z	M8	25	500
02210800030Z	M8	30	500
02210800035Z	M8	35	500
02210800040Z	M8	40	200
02210800045Z	M8	45	200
02210800050Z	M8	50	200
02210800075Z	M8	75	100
02210800120Z	M8	120	100
02210800140Z	M8	140	100
02211000020Z	M10	20	200
02211000025Z	M10	25	200
02211000030Z	M10	30	200
02211000035Z	M10	35	200
02211000040Z	M10	40	100
02211000045Z	M10	45	200
02211000050Z	M10	50	100
02211000060Z	M10	60	100
02211000070Z	M10	70	100
02211000075Z	M10	75	100
02211000080Z	M10	80	100
02211000090Z	M10	90	100
02211000100Z	M10	100	100
02211000120Z	M10	120	50
02211000130Z	M10	130	50
02211000150Z	M10	150	50
02211000350Z	M10	350	25
02211000465Z	M10	465	25
02211000760Z	M10	760	25
02210140080Z	1/4"	80	200

Consultar disponibilidad en otras medidas.

Medidas en mm.

0222 VARILLA ROSCADA PHILIPS

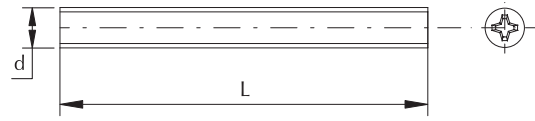

- Espárrago de rosca métrica.
- Huella Phillips en un extremo para favorecer el apriete.



CÓDIGO	(d)	L	⊕	ENVASE
02220800030Z	M8	30	PH2	2000
02220800060Z	M8	60	PH2	800
02220800070Z	M8	70	PH2	1000

CÓDIGO	(d)	L	⊕	ENVASE
02220800080Z	M8	80	PH2	1000
02220800090Z	M8	90	PH2	800
02220800100Z	M8	100	PH2	500

0223 MANGUITO ROSCADO HEXAGONAL

d	M5	M6	M8	M10	M12	M14	M16
S	8	10	13	17	19	22	24

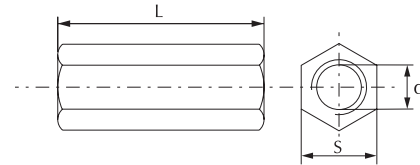

- Manguito roscado para uso de una llave hexagonal.
- Anclajes e instalaciones generales de conductos, canalizaciones, techos, iluminación entre otros.



CÓDIGO	(d)	L	ENVASE
02230500020Z	M5	20	100
02230600025Z	M6	25	200
02230600030Z	M6	30	200
02230800025Z	M8	25	100

CÓDIGO	(d)	L	ENVASE
02231000030Z	M10	30	150
02231200030Z	M12	30	50
02231400044Z	M14	44	50
02231600050Z	M16	50	50

### 0224 MANGUITO ROSCADO CILÍNDRICO

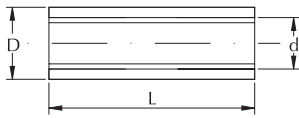

d	M6	M8	M10
D	10	11	13



- Manguito roscado para anclajes e instalaciones generales de conductos, canalizaciones, techos, iluminación entre otros.

CÓDIGO	(d)	L	ENVASE
02240600020Z	M6	20	200
02240600030Z	M6	30	200

CÓDIGO	(d)	L	ENVASE
02240800025Z	M8	25	200
02241000030Z	M10	30	100

Consultar disponibilidad en otras medidas.

### 0276 MANGUITO ROSCADO CILÍNDRICO

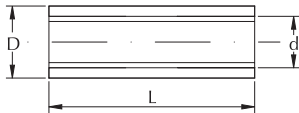

d	M6	M10	M12
D	8	14	15



- Manguito roscado para anclajes e instalaciones generales de conductos, canalizaciones, techos, iluminación entre otros.

CÓDIGO	(d)	L	ENVASE
02760600030Z	M6	30	200
02761000030Z	M10	30	100

CÓDIGO	(d)	L	ENVASE
02761200025Z	M12	25	100
02761200035Z	M12	35	100

Consultar disponibilidad en otras medidas.

### 0225 TUBO UNIÓN 1/4" SIN TORNILLO

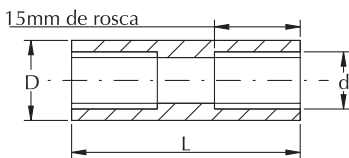

d	1/4"
D	8



- Tubo para unión de módulos en ensamblaje de muebles.

CÓDIGO	(d)	L	ENVASE
02250140020Z	1/4"	20	500
02250140025Z	1/4"	25	500
02250140030Z	1/4"	30	500
02250140035Z	1/4"	35	500
02250140040Z	1/4"	40	200
02250140045Z	1/4"	45	200
02250140050Z	1/4"	50	200
02250140055Z	1/4"	55	200
02250140060Z	1/4"	60	200
02250140065Z	1/4"	65	200

CÓDIGO	(d)	L	ENVASE
02250140070Z	1/4"	70	200
02250140075Z	1/4"	75	200
02250140080Z	1/4"	80	200
02250140085Z	1/4"	85	200
02250140090Z	1/4"	90	200
02250140100Z	1/4"	100	200
02250140110Z	1/4"	110	200
02250140120Z	1/4"	120	200
02250140125Z	1/4"	125	200

Medidas en mm.



0226 TUBO UNIÓN 1/4" CON 2 TORNILLOS ENSAMBLE 1/4" x 10

d	1/4"
D	14
K	3,5

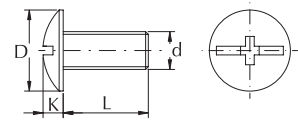

d	1/4"
D	8

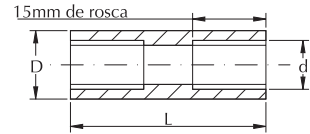

- Juego de tubo con tornillos combi para unión de módulos en ensamble de muebles.



CÓDIGO	( d )	L	ENVASE
02260140020N	1/4"	20	500
02260140025N	1/4"	25	500
02260140030N	1/4"	30	500
02260140035N	1/4"	35	500
02260140040N	1/4"	40	200
02260140045N	1/4"	45	200
02260140050N	1/4"	50	200
02260140055N	1/4"	55	200
02260140060N	1/4"	60	200
02260140065N	1/4"	65	200
02260140070N	1/4"	70	200
02260140075N	1/4"	75	200
02260140080N	1/4"	80	200
02260140085N	1/4"	85	200
02260140090N	1/4"	90	200
02260140100N	1/4"	100	200
02260140110N	1/4"	110	200
02260140120N	1/4"	120	200

CÓDIGO	( d )	L	ENVASE
02260140020U	1/4"	20	500
02260140025U	1/4"	25	500
02260140030U	1/4"	30	500
02260140035U	1/4"	35	500
02260140040U	1/4"	40	200
02260140045U	1/4"	45	200
02260140050U	1/4"	50	200
02260140055U	1/4"	55	200
02260140060U	1/4"	60	200
02260140065U	1/4"	65	200
02260140070U	1/4"	70	200
02260140075U	1/4"	75	200
02260140080U	1/4"	80	200
02260140085U	1/4"	85	200
02260140090U	1/4"	90	200
02260140100U	1/4"	100	200
02260140110U	1/4"	110	200
02260140120U	1/4"	120	200



CÓDIGO	( d )	L	ENVASE
02260140020L	1/4"	20	500
02260140025L	1/4"	25	500
02260140030L	1/4"	30	500
02260140035L	1/4"	35	500
02260140040L	1/4"	40	200
02260140045L	1/4"	45	200
02260140050L	1/4"	50	200
02260140055L	1/4"	55	200
02260140060L	1/4"	60	200
02260140065L	1/4"	65	200
02260140070L	1/4"	70	200
02260140075L	1/4"	75	200
02260140080L	1/4"	80	200
02260140085L	1/4"	85	200
02260140090L	1/4"	90	200
02260140100L	1/4"	100	200
02260140110L	1/4"	110	200
02260140120L	1/4"	120	200

CÓDIGO	( d )	L	ENVASE
02260140020Q	1/4"	20	500
02260140025Q	1/4"	25	500
02260140030Q	1/4"	30	500
02260140035Q	1/4"	35	500
02260140040Q	1/4"	40	200
02260140045Q	1/4"	45	200
02260140050Q	1/4"	50	200
02260140055Q	1/4"	55	200
02260140060Q	1/4"	60	200
02260140065Q	1/4"	65	200
02260140070Q	1/4"	70	200
02260140075Q	1/4"	75	200
02260140080Q	1/4"	80	200
02260140085Q	1/4"	85	200
02260140090Q	1/4"	90	200
02260140100Q	1/4"	100	200
02260140110Q	1/4"	110	200
02260140120Q	1/4"	120	200

Acabado Tubo Unión: Cincado.  
Acabados Tornillos: Cincado Negro, Cuero, Latonado, y Niquelado.

Medidas en mm.

0227 TUBO UNIÓN 1/4" CON 2 TORNILLOS ENSAMBLE 1/4" x 15

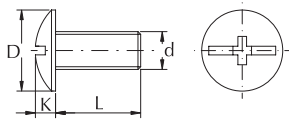

d	1/4"
D	14
K	3,5

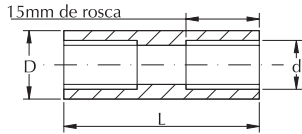

d	1/4"
D	8

- Juego de tubo con tornillos combi para unión de módulos en ensamble de muebles.



CÓDIGO	(d)	L	ENVASE
02270140020N	1/4"	20	500
02270140025N	1/4"	25	500
02270140030N	1/4"	30	500
02270140035N	1/4"	35	500
02270140040N	1/4"	40	200
02270140045N	1/4"	45	200
02270140050N	1/4"	50	200
02270140055N	1/4"	55	200
02270140060N	1/4"	60	200
02270140065N	1/4"	65	200
02270140070N	1/4"	70	200
02270140075N	1/4"	75	200
02270140080N	1/4"	80	200
02270140085N	1/4"	85	200
02270140090N	1/4"	90	200
02270140100N	1/4"	100	200
02270140110N	1/4"	110	200
02270140120N	1/4"	120	200

CÓDIGO	(d)	L	ENVASE
02270140020U	1/4"	20	500
02270140025U	1/4"	25	500
02270140030U	1/4"	30	500
02270140035U	1/4"	35	500
02270140040U	1/4"	40	200
02270140045U	1/4"	45	200
02270140050U	1/4"	50	200
02270140055U	1/4"	55	200
02270140060U	1/4"	60	200
02270140065U	1/4"	65	200
02270140070U	1/4"	70	200
02270140075U	1/4"	75	200
02270140080U	1/4"	80	200
02270140085U	1/4"	85	200
02270140090U	1/4"	90	200
02270140100U	1/4"	100	200
02270140110U	1/4"	110	200
02270140120U	1/4"	120	200



CÓDIGO	(d)	L	ENVASE
02270140020L	1/4"	20	500
02270140025L	1/4"	25	500
02270140030L	1/4"	30	500
02270140035L	1/4"	35	500
02270140040L	1/4"	40	200
02270140045L	1/4"	45	200
02270140050L	1/4"	50	200
02270140055L	1/4"	55	200
02270140060L	1/4"	60	200
02270140065L	1/4"	65	200
02270140070L	1/4"	70	200
02270140075L	1/4"	75	200
02270140080L	1/4"	80	200
02270140085L	1/4"	85	200
02270140090L	1/4"	90	200
02270140100L	1/4"	100	200
02270140110L	1/4"	110	200
02270140120L	1/4"	120	200

CÓDIGO	(d)	L	ENVASE
02270140020Q	1/4"	20	500
02270140025Q	1/4"	25	500
02270140030Q	1/4"	30	500
02270140035Q	1/4"	35	500
02270140040Q	1/4"	40	200
02270140045Q	1/4"	45	200
02270140050Q	1/4"	50	200
02270140055Q	1/4"	55	200
02270140060Q	1/4"	60	200
02270140065Q	1/4"	65	200
02270140070Q	1/4"	70	200
02270140075Q	1/4"	75	200
02270140080Q	1/4"	80	200
02270140085Q	1/4"	85	200
02270140090Q	1/4"	90	200
02270140100Q	1/4"	100	200
02270140110Q	1/4"	110	200
02270140120Q	1/4"	120	200

Acabado Tubo Unión: Cincado.  
Acabados Tornillos: Cincado Negro, Cuero, Latonado, y Niquelado.

Medidas en mm.

0228 HEMBRA ALLEN 4

rosca	M6
D	14
d	8
K	3,8
S	4

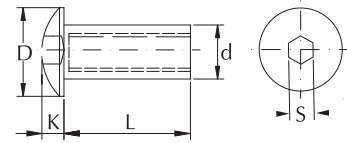

- Hembra embellecedor con huella hexagonal para ensamblaje de muebles.



CÓDIGO	(d)	L	○	ENVASE
02280600015B	M6	15	ALLEN 4	500

CÓDIGO	(d)	L	○	ENVASE
02280600015Z	M6	15	ALLEN 4	500

0229 HEMBRA ALLEN 5

rosca	M6	M8
D	12,5	20
d	8	10
K	3	3
S	5	5
n	10	9,5

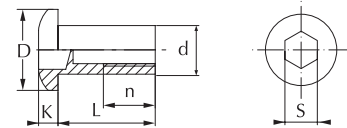

- Hembra embellecedor con huella hexagonal para ensamblaje de muebles.



CÓDIGO	(d)	L	○	ENVASE
02290600015Z	M6	15	ALLEN 5	500

CÓDIGO	(d)	L	○	ENVASE
02290800014Z	M8	14	ALLEN 5	500

Consultar cantidad mínima de servicio.

0230 HEMBRA ALLEN CABEZA PLANA

rosca	M6	M8
D	15	18
d	8	10
K	2,5	2
S	4	5

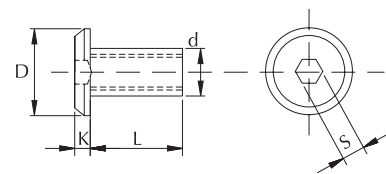

- Hembra embellecedor con huella hexagonal para ensamblaje de muebles.



CÓDIGO	(d)	L	○	ENVASE
02300800013Z	M8	13,5	ALLEN 5	500

CÓDIGO	(d)	L	○	ENVASE
02300600012Q	M6	12	ALLEN 4	500
02300600015Q	M6	15	ALLEN 4	500
02300600025Q	M6	25	ALLEN 4	500
02300600030Q	M6	30	ALLEN 4	500
02300800013Q	M8	13,5	ALLEN 5	500

Consultar cantidad mínima de servicio.  
Consultar disponibilidad en otras medidas.

0231 HEMBRA COMBI PHILIPS RANURA

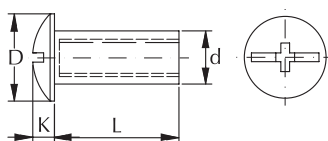

rosca	1/4"	M6
D	14	14
d	8	8
K	3,5	3,5

- Hembra embellecedor con huella combi para ensamblaje de muebles.



CÓDIGO	(d)	L	+	ENVASE
02310140015B	1/4"	15	PH3	500
02310140020B	1/4"	20	PH3	500
02310600015B	M6	15	PH3	500
02310600020B	M6	20	PH3	500



CÓDIGO	(d)	L	+	ENVASE
02310140015Z	1/4"	15	PH3	500
02310600015Z	M6	15	PH3	500
02310600020Z	M6	20	PH3	500



CÓDIGO	(d)	L	+	ENVASE
02310140015N	1/4"	15	PH3	500
02310600015N	M6	15	PH3	500



CÓDIGO	(d)	L	+	ENVASE
02310140015U	1/4"	15	PH3	500
02310140020U	1/4"	20	PH3	500



CÓDIGO	(d)	L	+	ENVASE
02310140015L	1/4"	15	PH3	500
02310140020L	1/4"	20	PH3	500
02310600015L	M6	15	PH3	500



CÓDIGO	(d)	L	+	ENVASE
02310600015Q	M6	15	PH3	500

0232 HEMBRA GRAFILADA

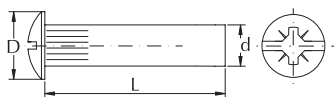

rosca	M6
D	14
d	8

- Hembra embellecedor con huella combi para ensamblaje de muebles.



CÓDIGO	(d)	L	+	ENVASE
02320600028Q	M6	28	PZ3	500
02320600030Q	M6	30	PZ3	500



CÓDIGO	(d)	L	+	ENVASE
02320600030L	M6	30	PZ3	500

0233 HEMBRA GRAFILADA CON ARANDELA

rosca	M4
D	11
d	5

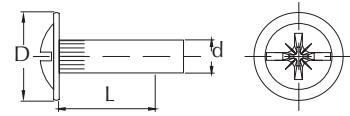

- Hembra embellecedor y arandela estampada con huella combi para ensamblaje de muebles.



CÓDIGO	(d)	L	+	ENVASE
02330400015Q	M4	15	PZ2	1000

CÓDIGO	(d)	L	+	ENVASE
02330400029Q	M4	29	PZ2	500

Consultar cantidad mínima de servicio.

0286 TORNILLO TIRADOR CON ARANDELA

d	M4
D	11

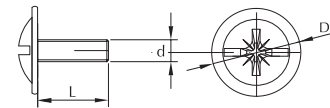

- Tornillo combi con arandela estampada.
- Para el atornillado de tiradores en cajones.



CÓDIGO	(d)	L	+	ENVASE
02860400015Q	M4	15	PZ2	500

Consultar cantidad mínima de servicio.

0234 HEMBRAS ESPECIALES

Medida	M4	M8
D	11	15
d	6 / 7	10
K	2,5	2,5
n	10	10

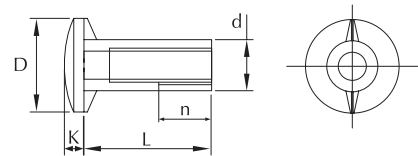

d	M4
D	11
K	3

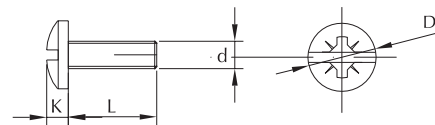

- Hembra embellecedor sin huella para ensamblaje de muebles.



CÓDIGO	(d)	L	ENVASE
02340800016Z	M8	16	500



CÓDIGO	(d)	L	+	ENVASE
02340407015Q	M4	15		1000
02340400013Q	M4	13	PZ2	1000

0235 TORNILLO TIRADOR

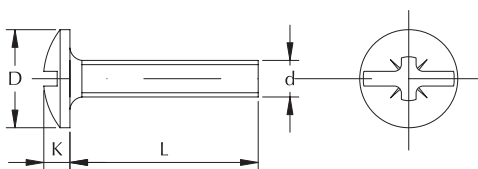

d	M4
D	9
K	2,5



- Tornillo huella combi pozidrive más ranura.
- Atornillado de tiradores en cajones.

CÓDIGO	(d)	L	+	ENVASE
02350400007Z	M4	7	PZ2	1000
02350400008Z	M4	8	PZ2	1000
02350400010Z	M4	10	PZ2	1000
02350400011Z	M4	11	PZ2	1000
02350400012Z	M4	12	PZ2	1000
02350400013Z	M4	13	PZ2	1000
02350400014Z	M4	14	PZ2	1000
02350400015Z	M4	15	PZ2	1000
02350400016Z	M4	16	PZ2	1000
02350400018Z	M4	18	PZ2	1000
02350400019Z	M4	19	PZ2	1000
02350400020Z	M4	20	PZ2	1000
02350400021Z	M4	21	PZ2	1000
02350400022Z	M4	22	PZ2	1000
02350400023Z	M4	23	PZ2	1000
02350400024Z	M4	24	PZ2	1000

CÓDIGO	(d)	L	+	ENVASE
02350400025Z	M4	25	PZ2	1000
02350400026Z	M4	26	PZ2	1000
02350400027Z	M4	27	PZ2	1000
02350400028Z	M4	28	PZ2	1000
02350400030Z	M4	30	PZ2	1000
02350400032Z	M4	32	PZ2	1000
02350400035Z	M4	35	PZ2	1000
02350400037Z	M4	37	PZ2	1000
02350400038Z	M4	38	PZ2	1000
02350400040Z	M4	40	PZ2	1000
02350400045Z	M4	45	PZ2	500
02350400047Z	M4	47	PZ2	500
02350400048Z	M4	48	PZ2	500
02350400050Z	M4	50	PZ2	500
02350400055Z	M4	55	PZ2	500
02350400060Z	M4	60	PZ2	500



CÓDIGO	(d)	L	+	ENVASE
02350400022Q	M4	22	PZ2	1000

CÓDIGO	(d)	L	+	ENVASE
02350400025Q	M4	25	PZ2	1000



CÓDIGO	(d)	L	+	ENVASE
02350400008U	M4	8	PZ2	1000
02350400010U	M4	10	PZ2	1000
02350400012U	M4	12	PZ2	1000
02350400013U	M4	13	PZ2	1000
02350400015U	M4	15	PZ2	1000
02350400016U	M4	16	PZ2	1000
02350400018U	M4	18	PZ2	1000
02350400019U	M4	19	PZ2	1000
02350400020U	M4	20	PZ2	1000
02350400025U	M4	25	PZ2	1000

CÓDIGO	(d)	L	+	ENVASE
02350400026U	M4	26	PZ2	1000
02350400028U	M4	28	PZ2	1000
02350400030U	M4	30	PZ2	1000
02350400032U	M4	32	PZ2	1000
02350400035U	M4	35	PZ2	1000
02350400037U	M4	37	PZ2	1000
02350400038U	M4	38	PZ2	1000
02350400040U	M4	40	PZ2	1000
02350400045U	M4	45	PZ2	1000

0236 TORNILLO TIRADOR FRACCIONADO

d	M4
D	9
K	2,5

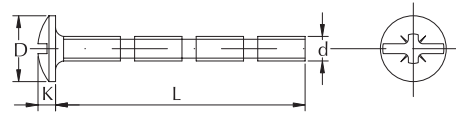

- Tornillo huella combi pozidrive más ranura de longitud variable según aplicación para atornillado de tiradores en cajones.
- Las diferentes huellas de la rosca permiten emplear el tornillo con diferentes medidas.



CÓDIGO	(d)	L	⊕	ENVASE
02360400045Z	M4	45	PZ2	1000

0237 TORNILLO SILLA 3/16"

d	3/16"
D	11
K	2

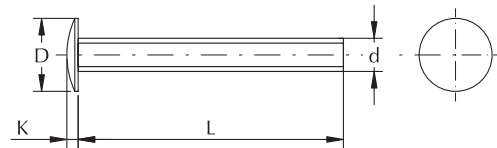

- Tornillo embellecedor sin huella para sillería.



CÓDIGO	(d)	L	ENVASE
02373160015Q	3/16"	15	500
02373160020Q	3/16"	20	500
02373160025Q	3/16"	25	500
02373160030Q	3/16"	30	500
02373160035Q	3/16"	35	500

CÓDIGO	(d)	L	ENVASE
02373160040Q	3/16"	40	500
02373160045Q	3/16"	45	500
02373160050Q	3/16"	50	500
02373160060Q	3/16"	60	500
02373160070Q	3/16"	70	500

0238 TORNILLO EMBELLECEDOR CABEZA PLANA ALLEN

d	M4	M6	M8
D	10	15	19
K	2	2,5	3
S	2,5	4	5

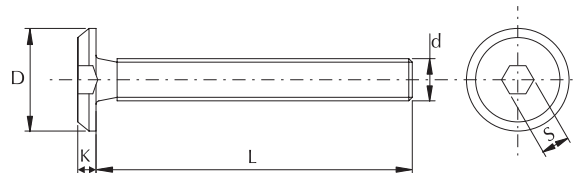

- Tornillo embellecedor con huella hexagonal y cabeza plana para ensamblaje de muebles.



CÓDIGO	(d)	L	⊙	ENVASE
02380400017Q	M4	17	ALLEN 2,5	500
02380600010Q	M6	10	ALLEN 4	500
02380600012Q	M6	12	ALLEN 4	500
02380600015Q	M6	15	ALLEN 4	500
02380600020Q	M6	20	ALLEN 4	500
02380600025Q	M6	25	ALLEN 4	500
02380600030Q	M6	30	ALLEN 4	500
02380600035Q	M6	35	ALLEN 4	500
02380600040Q	M6	40	ALLEN 4	500
02380600045Q	M6	45	ALLEN 4	250
02380600050Q	M6	50	ALLEN 4	500
02380600055Q	M6	55	ALLEN 4	200
02380600060Q	M6	60	ALLEN 4	200
02380600070Q	M6	70	ALLEN 4	200

CÓDIGO	(d)	L	⊙	ENVASE
02380600080Q	M6	80	ALLEN 4	200
02380800015Q	M8	15	ALLEN 5	200
02380800020Q	M8	20	ALLEN 5	200
02380800025Q	M8	25	ALLEN 5	200
02380800030Q	M8	30	ALLEN 5	200
02380800035Q	M8	35	ALLEN 5	200
02380800040Q	M8	40	ALLEN 5	200
02380800045Q	M8	45	ALLEN 5	200
02380800050Q	M8	50	ALLEN 5	200
02380800060Q	M8	60	ALLEN 5	100
02380800070Q	M8	70	ALLEN 5	100
02380800080Q	M8	80	ALLEN 5	100
02380800090Q	M8	90	ALLEN 5	100
02380800100Q	M8	100	ALLEN 5	100

Consultar disponibilidad en otras medidas.  
Consultar cantidad mínima de servicio.

Medidas en mm. Puntas de atornillar disponibles en página 272.

0239 TORNILLO EMBELLECEDOR ALLEN

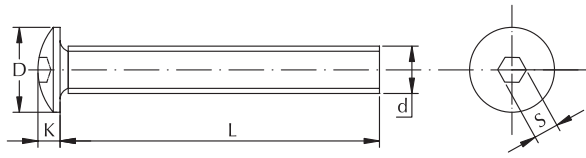

d	M6	1/4"	M8
D	14	14	17
K	3	3	4
S	4	4	5



- Tornillo embellecedor con huella hexagonal para ensamblaje de muebles.

CÓDIGO	(d)	L	○	ENVASE
02390600010B	M6	10	ALLEN 4	500
02390600015B	M6	15	ALLEN 4	500
02390600020B	M6	20	ALLEN 4	500
02390600025B	M6	25	ALLEN 4	500
02390600030B	M6	30	ALLEN 4	500
02390600035B	M6	35	ALLEN 4	500
02390600040B	M6	40	ALLEN 4	250
02390600045B	M6	45	ALLEN 4	250
02390600050B	M6	50	ALLEN 4	250
02390600060B	M6	60	ALLEN 4	250
02390600070B	M6	70	ALLEN 4	250
02390600080B	M6	80	ALLEN 4	200
02390600090B	M6	90	ALLEN 4	100
02390600100B	M6	100	ALLEN 4	100
02390800020B	M8	20	ALLEN 5	200
02390800025B	M8	25	ALLEN 5	200
02390800030B	M8	30	ALLEN 5	200
02390800035B	M8	35	ALLEN 5	200
02390800040B	M8	40	ALLEN 5	200
02390800045B	M8	45	ALLEN 5	200

CÓDIGO	(d)	L	○	ENVASE
02390800050B	M8	50	ALLEN 5	200
02390800060B	M8	60	ALLEN 5	200
02390800070B	M8	70	ALLEN 5	100
02390800080B	M8	80	ALLEN 5	100
02390800090B	M8	90	ALLEN 5	100
02390800100B	M8	100	ALLEN 5	100
02390800110B	M8	110	ALLEN 5	100
02390800120B	M8	120	ALLEN 5	50
02390800130B	M8	130	ALLEN 5	50
02390140015B	1/4"	15	ALLEN 4	500
02390140025B	1/4"	25	ALLEN 4	200
02390140035B	1/4"	35	ALLEN 4	200
02390140045B	1/4"	45	ALLEN 4	200
02390140060B	1/4"	60	ALLEN 4	200
02390140070B	1/4"	70	ALLEN 4	100
02390140090B	1/4"	90	ALLEN 4	100
02390140100B	1/4"	100	ALLEN 4	100
02390140105B	1/4"	105	ALLEN 4	100
02390140115B	1/4"	115	ALLEN 4	100
02390140140B	1/4"	140	ALLEN 4	100



CÓDIGO	(d)	L	○	ENVASE
02390600010Z	M6	10	ALLEN 4	500
02390600015Z	M6	15	ALLEN 4	500
02390600020Z	M6	20	ALLEN 4	500
02390600025Z	M6	25	ALLEN 4	500
02390600030Z	M6	30	ALLEN 4	250
02390600035Z	M6	35	ALLEN 4	500
02390600040Z	M6	40	ALLEN 4	250
02390600045Z	M6	45	ALLEN 4	250
02390600050Z	M6	50	ALLEN 4	250
02390600060Z	M6	60	ALLEN 4	200
02390600070Z	M6	70	ALLEN 4	200
02390600080Z	M6	80	ALLEN 4	200
02390600090Z	M6	90	ALLEN 4	100
02390600100Z	M6	100	ALLEN 4	100

CÓDIGO	(d)	L	○	ENVASE
02390800020Z	M8	20	ALLEN 5	200
02390800025Z	M8	25	ALLEN 5	200
02390800030Z	M8	30	ALLEN 5	200
02390800035Z	M8	35	ALLEN 5	200
02390800040Z	M8	40	ALLEN 5	200
02390800045Z	M8	45	ALLEN 5	100
02390800050Z	M8	50	ALLEN 5	200
02390800060Z	M8	60	ALLEN 5	200
02390800070Z	M8	70	ALLEN 5	100
02390800080Z	M8	80	ALLEN 5	100
02390800090Z	M8	90	ALLEN 5	100
02390800100Z	M8	100	ALLEN 5	100
02390800110Z	M8	110	ALLEN 5	100
02390140045Z	1/4"	45	ALLEN 4	1500

Consultar disponibilidad en otras medidas.  
Consultar disponibilidad en otros recubrimientos.



0239 TORNILLO EMBELLECEDOR ALLEN

d	M6	1/4"
D	14	14
K	3	3
S	4	4



CÓDIGO	(d)	L	⊙	ENVASE
02390600010N	M6	10	ALLEN 4	500
02390600015N	M6	15	ALLEN 4	500
02390600020N	M6	20	ALLEN 4	500

CÓDIGO	(d)	L	⊙	ENVASE
02390600025N	M6	25	ALLEN 4	2500
02390600035N	M6	35	ALLEN 4	250



CÓDIGO	(d)	L	⊙	ENVASE
02390600030L	M6	30	ALLEN 4	250
02390600035L	M6	35	ALLEN 4	250
02390600040L	M6	40	ALLEN 4	250

CÓDIGO	(d)	L	⊙	ENVASE
02390600060L	M6	60	ALLEN 4	200
02390140015L	1/4"	15	ALLEN 4	500
02390140025L	1/4"	25	ALLEN 4	200



CÓDIGO	(d)	L	⊙	ENVASE
02390600080P	M6	80	ALLEN 4	200
02390600090P	M6	90	ALLEN 4	100
02390600100P	M6	100	ALLEN 4	100

CÓDIGO	(d)	L	⊙	ENVASE
02390600110P	M6	110	ALLEN 4	500
02390800030P	M8	30	ALLEN 5	1200
02390140100P	1/4"	100	ALLEN 4	100



CÓDIGO	(d)	L	⊙	ENVASE
02390600050A	M6	50	ALLEN 4	400

0242 TORNILLO ENSAMBLE COMBI CUNA

d	3/16"	M6
D	11	11
K	3	3

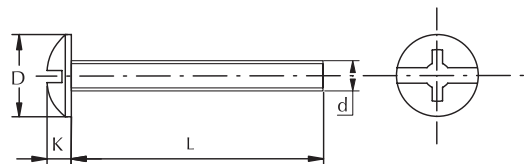

• Tornillo embellecedor combi para ensamblaje de muebles.

CÓDIGO	(d)	L	⊕	ENVASE
02420600025L	M6	25	PH2	500
02423160038L	3/16"	38	PH2	500
02423160048L	3/16"	48	PH2	200

CÓDIGO	(d)	L	⊕	ENVASE
02423160050L	3/16"	50	PH2	200
02423160065L	3/16"	65	PH2	200

0240 TORNILLO ENSAMBLE COMBI

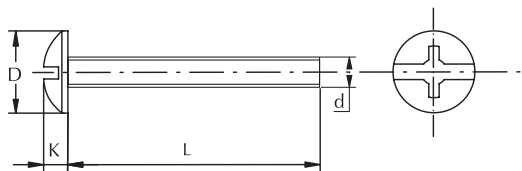

d	M6	1/4"
D	14	14
K	3,5	3,5



• Tornillo embellecedor combi para ensamblaje de muebles.

CÓDIGO	(d)	L	⊕	ENVASE
02400140010B	1/4"	10	PH3	1000
02400140015B	1/4"	15	PH3	1000
02400140025B	1/4"	25	PH3	200
02400140035B	1/4"	35	PH3	200
02400140045B	1/4"	45	PH3	200

CÓDIGO	(d)	L	⊕	ENVASE
02400140070B	1/4"	70	PH3	200
02400140120B	1/4"	120	PH3	100
02400600015B	M6	15	PH3	1000
02400600050B	M6	50	PH3	200



CÓDIGO	(d)	L	⊕	ENVASE
02400140030Z	1/4"	30	PH3	200
02400600010Z	M6	10	PH3	1000
02400600015Z	M6	15	PH3	1000
02400600020Z	M6	20	PH3	500
02400600025Z	M6	25	PH3	500
02400600030Z	M6	30	PH3	500

CÓDIGO	(d)	L	⊕	ENVASE
02400600035Z	M6	35	PH3	250
02400600040Z	M6	40	PH3	200
02400600045Z	M6	45	PH3	200
02400600050Z	M6	50	PH3	200
02400600055Z	M6	55	PH3	200
02400600060Z	M6	60	PH3	200



CÓDIGO	(d)	L	⊕	ENVASE
02400140010N	1/4"	10	PH3	1000
02400140015N	1/4"	15	PH3	1000

CÓDIGO	(d)	L	⊕	ENVASE
02400600020N	M6	20	PH3	1000
02400600030N	M6	30	PH3	500



CÓDIGO	(d)	L	⊕	ENVASE
02400140010U	1/4"	10	PH3	1000
02400140015U	1/4"	15	PH3	1000

CÓDIGO	(d)	L	⊕	ENVASE
02400600025U	M6	25	PH3	2500



CÓDIGO	(d)	L	⊕	ENVASE
02400140010L	1/4"	10	PH3	1000
02400140015L	1/4"	15	PH3	1000
02400140035L	1/4"	35	PH3	200

CÓDIGO	(d)	L	⊕	ENVASE
02400140080L	1/4"	80	PH3	1
02400600015L	M6	15	PH3	1000
02400600020L	M6	20	PH3	1000



CÓDIGO	(d)	L	⊕	ENVASE
02400140010Q	1/4"	10	PH3	1000
02400140015Q	1/4"	15	PH3	1000

CÓDIGO	(d)	L	⊕	ENVASE
02400140030Q	1/4"	30	PH3	200
02400140045Q	1/4"	45	PH3	200

Consultar cantidad mínima de servicio.

Medidas en mm.

 Puntas de atornillar disponibles en página 272.

0241 TORNILLO ENSAMBLE DOBLE RANURA

d	M6	1/4"
D	14	14
K	3,5	3,5

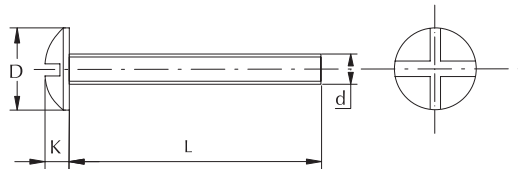

• Tornillo embellecedor doble ranura para ensamble de muebles.



CÓDIGO	(d)	L	ENVASE
02410140025B	1/4"	25	3000
02410140030B	1/4"	30	2000
02410140035B	1/4"	35	2000
02410140045B	1/4"	45	2000
02410140060B	1/4"	60	1500
02410140070B	1/4"	70	1000
02410140075B	1/4"	75	1000

CÓDIGO	(d)	L	ENVASE
02410140080B	1/4"	80	1000
02410140085B	1/4"	85	900
02410140090B	1/4"	90	800
02410140105B	1/4"	105	700
02410140110B	1/4"	110	800
02410140115B	1/4"	115	1000
02410140120B	1/4"	120	500



CÓDIGO	(d)	L	ENVASE
02410140030U	1/4"	30	2000
02410140035U	1/4"	35	2000

CÓDIGO	(d)	L	ENVASE
02410140060U	1/4"	60	1000



CÓDIGO	(d)	L	ENVASE
02410140020L	1/4"	20	2000
02410140025L	1/4"	25	2000
02410140030L	1/4"	30	2000
02410140035L	1/4"	35	2000

CÓDIGO	(d)	L	ENVASE
02410140045L	1/4"	45	1200
02410140060L	1/4"	60	1500
02410140110L	1/4"	110	500



CÓDIGO	(d)	L	ENVASE
02410140070Q	1/4"	70	1000
02410140080Q	1/4"	80	1000

CÓDIGO	(d)	L	ENVASE
02410140090Q	1/4"	90	500
02410600080Q	M6	80	1000



CÓDIGO	(d)	L	ENVASE
02410140030P	1/4"	30	2000
02410140035P	1/4"	35	2000
02410140045P	1/4"	45	2000

CÓDIGO	(d)	L	ENVASE
02410140060P	1/4"	60	1000
02410140070P	1/4"	70	1000



CÓDIGO	(d)	L	ENVASE
02410140090Z	1/4"	90	800

Consultar cantidad mínima de servicio.

Medidas en mm.

0278 TORNILLO EMBELLECEDOR DOBLE RANURA

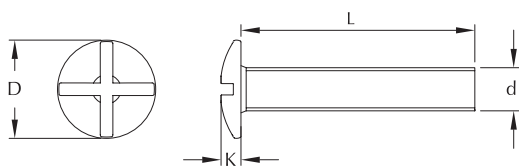

d	M8
D	17
K	4



- Tornillo embellecedor doble ranura.

CÓDIGO	(d)	L	ENVASE
02780800040B	M8	40	200
02780800050B	M8	50	200
02780800070B	M8	70	200
02780800080B	M8	80	200

CÓDIGO	(d)	L	ENVASE
02780800090B	M8	90	200
02780800100B	M8	100	100
02780800110B	M8	110	100
02780800120B	M8	120	400



CÓDIGO	(d)	L	ENVASE
02780800120U	M8	120	400



CÓDIGO	(d)	L	ENVASE
02780800120P	M8	120	400

0244 DIN 7985 PH

d	M2,5	M3	M4	M5	M6	M8
D	6	6	8	10	12	16
K	2,4	2,4	3,1	3,8	4,6	6

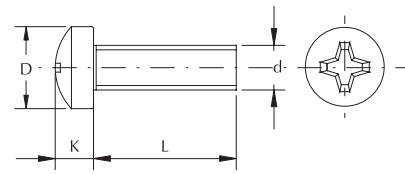

- Tornillo métrico de cabeza alomada y huella Phillips.

CÓDIGO	(d)	L	⊕	ENVASE
02440250006Z	M2,5	6	PH1	2000
02440250010Z	M2,5	10	PH1	2000
02440250016Z	M2,5	16	PH1	2000
02440300004Z	M3	4	PH1	1000
02440300005Z	M3	5	PH1	1000
02440300006Z	M3	6	PH1	1000
02440300008Z	M3	8	PH1	1000
02440300010Z	M3	10	PH1	1000
02440300012Z	M3	12	PH1	1000
02440300015Z	M3	15	PH1	1000
02440300020Z	M3	20	PH1	1000
02440300025Z	M3	25	PH1	1000
02440300030Z	M3	30	PH1	1000
02440300035Z	M3	35	PH1	1000
02440300040Z	M3	40	PH1	1000
02440300050Z	M3	50	PH1	1000
02440400006Z	M4	6	PH2	1000
02440400008Z	M4	8	PH2	1000
02440400010Z	M4	10	PH2	1000
02440400012Z	M4	12	PH2	1000
02440400015Z	M4	15	PH2	1000
02440400016Z	M4	16	PH2	1000
02440400020Z	M4	20	PH2	1000
02440400025Z	M4	25	PH2	1000
02440400030Z	M4	30	PH2	1000
02440400035Z	M4	35	PH2	1000
02440400040Z	M4	40	PH2	1000
02440400050Z	M4	50	PH2	500
02440400055Z	M4	55	PH2	500
02440400060Z	M4	60	PH2	500

CÓDIGO	(d)	L	⊕	ENVASE
02440400070Z	M4	70	PH2	500
02440500006Z	M5	6	PH2	1000
02440500008Z	M5	8	PH2	1000
02440500010Z	M5	10	PH2	1000
02440500015Z	M5	15	PH2	1000
02440500016Z	M5	16	PH2	1000
02440500020Z	M5	20	PH2	1000
02440500025Z	M5	25	PH2	500
02440500030Z	M5	30	PH2	1000
02440500035Z	M5	35	PH2	500
02440500040Z	M5	40	PH2	500
02440500045Z	M5	45	PH2	500
02440500050Z	M5	50	PH2	500
02440500055Z	M5	55	PH2	500
02440500060Z	M5	60	PH2	500
02440600010Z	M6	10	PH3	1000
02440600012Z	M6	12	PH3	1000
02440600015Z	M6	15	PH3	1000
02440600016Z	M6	16	PH3	1000
02440600020Z	M6	20	PH3	1000
02440600025Z	M6	25	PH3	500
02440600030Z	M6	30	PH3	500
02440600035Z	M6	35	PH3	500
02440600040Z	M6	40	PH3	250
02440600045Z	M6	45	PH3	200
02440600050Z	M6	50	PH3	200
02440600055Z	M6	55	PH3	200
02440600060Z	M6	60	PH3	200
02440600070Z	M6	70	PH3	200
02440800020Z	M8	20	PH4	200

Consultar disponibilidad en otras medidas.  
Consultar disponibilidad en otros recubrimientos.

## 0245 DIN 7985 STAR

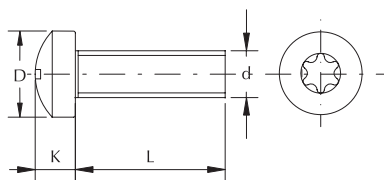

d	M2	M2,5	M3	M4	M5	M6	M8
D	4	5	6	8	10	12	16
K	1,72	2,12	2,52	3,25	3,95	4,75	6,15

- Tornillo métrico de cabeza alomada y huella hexabobular.

CÓDIGO	(d)	L	⊛	ENVASE
02450200004Z	M2	4	T60	1000
02450200005Z	M2	5	T60	1000
02450200006Z	M2	6	T60	1000
02450200008Z	M2	8	T60	1000
02450200010Z	M2	10	T60	1000
02450200012Z	M2	12	T60	1000
02450250005Z	M2,5	5	T80	1000
02450250006Z	M2,5	6	T80	1000
02450250008Z	M2,5	8	T80	1000
02450250010Z	M2,5	10	T80	1000
02450250012Z	M2,5	12	T80	1000
02450250016Z	M2,5	16	T80	1000
02450300004Z	M3	4	T10	1000
02450300005Z	M3	5	T10	1000
02450300006Z	M3	6	T10	1000
02450300008Z	M3	8	T10	1000
02450300010Z	M3	10	T10	1000
02450300012Z	M3	12	T10	1000
02450300016Z	M3	16	T10	1000
02450300025Z	M3	25	T10	1000
02450300030Z	M3	30	T10	1000
02450300035Z	M3	35	T10	1000
02450300040Z	M3	40	T10	500
02450300045Z	M3	45	T10	500
02450300050Z	M3	50	T10	500
02450400008Z	M4	8	T20	1000
02450400010Z	M4	10	T20	1000

CÓDIGO	(d)	L	⊛	ENVASE
02450400012Z	M4	12	T20	1000
02450400016Z	M4	16	T20	1000
02450400020Z	M4	20	T20	1000
02450400025Z	M4	25	T20	1000
02450400040Z	M4	40	T20	500
02450400045Z	M4	45	T20	500
02450400050Z	M4	50	T20	250
02450500006Z	M5	6	T25	1000
02450500008Z	M5	8	T25	1000
02450500010Z	M5	10	T25	1000
02450500020Z	M5	20	T25	500
02450500025Z	M5	25	T25	500
02450500030Z	M5	30	T25	500
02450500035Z	M5	35	T25	500
02450500040Z	M5	40	T25	250
02450500045Z	M5	45	T25	250
02450600010Z	M6	10	T30	500
02450600012Z	M6	12	T30	500
02450600016Z	M6	16	T30	500
02450600020Z	M6	20	T30	500
02450600025Z	M6	25	T30	250
02450600030Z	M6	30	T30	250
02450600045Z	M6	45	T30	250
02450600050Z	M6	50	T30	250
02450800012Z	M8	12	T40	250
02450800016Z	M8	16	T40	250
02450800020Z	M8	20	T40	250

Consultar cantidad mínima de servicio.

Consultar disponibilidad en otras medidas.

0246 DIN 965 PH

d	M3	M4	M5	M6	M8
D	5,7	7,5	9	11	14,1
K	1,6	2,2	2,5	3	4

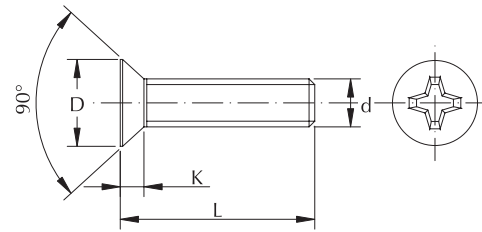

- Tornillo métrico de cabeza avellanada y huella Phillips.

CÓDIGO	(d)	L	+	ENVASE
02460300006Z	M3	6	PH1	1000
02460300008Z	M3	8	PH1	1000
02460300010Z	M3	10	PH1	1000
02460300015Z	M3	15	PH1	1000
02460300020Z	M3	20	PH1	1000
02460300025Z	M3	25	PH1	1000
02460300030Z	M3	30	PH1	1000
02460300035Z	M3	35	PH1	1000
02460300040Z	M3	40	PH1	1000
02460400006Z	M4	6	PH2	1000
02460400008Z	M4	8	PH2	1000
02460400010Z	M4	10	PH2	1000
02460400012Z	M4	12	PH2	1000
02460400015Z	M4	15	PH2	1000
02460400016Z	M4	16	PH2	1000
02460400020Z	M4	20	PH2	1000
02460400022Z	M4	22	PH2	2000
02460400025Z	M4	25	PH2	1000
02460400030Z	M4	30	PH2	1000
02460400035Z	M4	35	PH2	1000
02460400040Z	M4	40	PH2	1000
02460400045Z	M4	45	PH2	500
02460400050Z	M4	50	PH2	500
02460400055Z	M4	55	PH2	500
02460400060Z	M4	60	PH2	500
02460500006Z	M5	6	PH2	1000
02460500008Z	M5	8	PH2	1000
02460500010Z	M5	10	PH2	1000
02460500012Z	M5	12	PH2	1000
02460500015Z	M5	15	PH2	1000
02460500020Z	M5	20	PH2	1000
02460500025Z	M5	25	PH2	1000

CÓDIGO	(d)	L	+	ENVASE
02460500030Z	M5	30	PH2	1000
02460500035Z	M5	35	PH2	1000
02460500040Z	M5	40	PH2	500
02460500045Z	M5	45	PH2	500
02460500050Z	M5	50	PH2	500
02460500060Z	M5	60	PH2	500
02460500070Z	M5	70	PH2	250
02460600010Z	M6	10	PH3	1000
02460600012Z	M6	12	PH3	1000
02460600015Z	M6	15	PH3	1000
02460600016Z	M6	16	PH3	1000
02460600020Z	M6	20	PH3	500
02460600025Z	M6	25	PH3	500
02460600030Z	M6	30	PH3	500
02460600035Z	M6	35	PH3	500
02460600040Z	M6	40	PH3	500
02460600045Z	M6	45	PH3	300
02460600050Z	M6	50	PH3	200
02460600055Z	M6	55	PH3	200
02460600060Z	M6	60	PH3	200
02460600065Z	M6	65	PH3	200
02460600070Z	M6	70	PH3	200
02460600080Z	M6	80	PH3	200
02460800020Z	M8	20	PH4	250
02460800025Z	M8	25	PH4	250
02460800030Z	M8	30	PH4	250
02460800035Z	M8	35	PH4	250
02460800040Z	M8	40	PH4	250
02460800045Z	M8	45	PH4	250
02460800050Z	M8	50	PH4	250
02460800055Z	M8	55	PH4	100
02460800060Z	M8	60	PH4	100

CÓDIGO	(d)	L	+	ENVASE
02460500020N	M5	20	PH2	7700
02460500030N	M5	30	PH2	5000

CÓDIGO	(d)	L	+	ENVASE
02460600040N	M6	40	PH3	200
02460600045N	M6	45	PH3	2000



0247 DIN 965 STAR

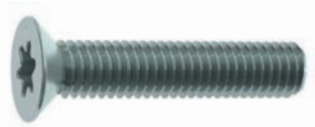
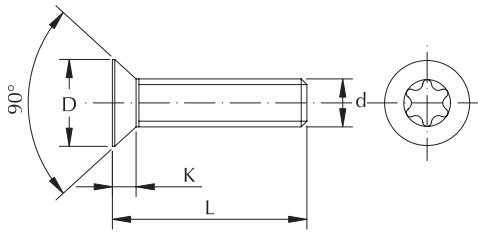

d	M2	M2,5	M3	M4	M5	M6	M8
D	3,8	4,7	5,6	7,5	9,2	11	14,5
K	1,2	1,5	1,65	2,2	2,5	3	4

- Tornillo métrico de cabeza avellanada y huella hexalobular.

CÓDIGO	(d)	L	⊕	ENVASE
02470200006Z	M2	6	T60	1000
02470200008Z	M2	8	T60	1000
02470200010Z	M2	10	T60	1000
02470200012Z	M2	12	T60	1000
02470200016Z	M2	16	T60	1000
02470250004Z	M2,5	4	T80	1000
02470250008Z	M2,5	8	T80	1000
02470250010Z	M2,5	10	T80	1000
02470250012Z	M2,5	12	T80	1000
02470250016Z	M2,5	16	T80	1000
02470250020Z	M2,5	20	T80	1000
02470250025Z	M2,5	25	T80	1000
02470300006Z	M3	6	T10	1000
02470300008Z	M3	8	T10	1000
02470300010Z	M3	10	T10	1000
02470300012Z	M3	12	T10	1000
02470300016Z	M3	16	T10	1000
02470300020Z	M3	20	T10	1000
02470300035Z	M3	35	T10	1000
02470300040Z	M3	40	T10	1000
02470300045Z	M3	45	T10	1000
02470300050Z	M3	50	T10	500
02470400005Z	M4	5	T20	1000
02470400006Z	M4	6	T20	1000
02470400012Z	M4	12	T20	1000
02470400016Z	M4	16	T20	1000

CÓDIGO	(d)	L	⊕	ENVASE
02470400020Z	M4	20	T20	1000
02470400025Z	M4	25	T20	1000
02470400030Z	M4	30	T20	1000
02470400035Z	M4	35	T20	1000
02470400050Z	M4	50	T20	500
02470500006Z	M5	6	T25	1000
02470500008Z	M5	8	T25	1000
02470500010Z	M5	10	T25	1000
02470500012Z	M5	12	T25	1000
02470500016Z	M5	16	T25	1000
02470500030Z	M5	30	T25	500
02470500035Z	M5	35	T25	500
02470500040Z	M5	40	T25	500
02470500045Z	M5	45	T25	250
02470500050Z	M5	50	T25	250
02470600008Z	M6	8	T30	1000
02470600016Z	M6	16	T30	500
02470600020Z	M6	20	T30	500
02470600025Z	M6	25	T30	500
02470600030Z	M6	30	T30	500
02470600035Z	M6	35	T30	250
02470600040Z	M6	40	T30	250
02470800012Z	M8	12	T40	500
02470800016Z	M8	16	T40	500
02470800020Z	M8	20	T40	250

Consultar cantidad mínima de servicio.



d	M3	M4	M5	M6
D	5,7	7,5	9	11
K	1,6	2,2	2,5	3

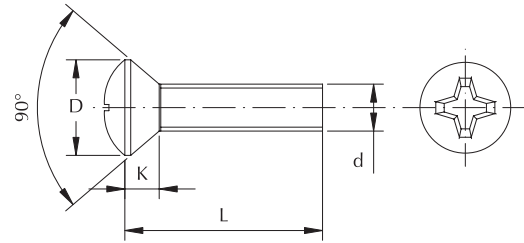

- Tornillo cabeza gota sebo con huella Phillips



CÓDIGO	(d)	L	⊕	ENVASE
02480300006Z	M3	6	PH1	1000
02480300008Z	M3	8	PH1	1000
02480300010Z	M3	10	PH1	1000
02480300016Z	M3	16	PH1	1000
02480300020Z	M3	20	PH1	1000
02480300025Z	M3	25	PH1	1000
02480300030Z	M3	30	PH1	1000
02480300035Z	M3	35	PH1	1000
02480400006Z	M4	6	PH2	1000
02480400008Z	M4	8	PH2	1000
02480400010Z	M4	10	PH2	1000
02480400015Z	M4	15	PH2	1000
02480400016Z	M4	16	PH2	1000
02480400020Z	M4	20	PH2	1000
02480400025Z	M4	25	PH2	1000
02480400030Z	M4	30	PH2	1000
02480400035Z	M4	35	PH2	1000
02480400040Z	M4	40	PH2	1000
02480400045Z	M4	45	PH2	1000
02480400050Z	M4	50	PH2	1000
02480500010Z	M5	10	PH2	1000

CÓDIGO	(d)	L	⊕	ENVASE
02480500012Z	M5	12	PH2	1
02480500015Z	M5	15	PH2	1000
02480500020Z	M5	20	PH2	1000
02480500025Z	M5	25	PH2	1000
02480500030Z	M5	30	PH2	500
02480500035Z	M5	35	PH2	1000
02480500038Z	M5	38	PH2	500
02480500040Z	M5	40	PH2	500
02480500045Z	M5	45	PH2	500
02480500050Z	M5	50	PH2	500
02480600010Z	M6	10	PH3	500
02480600014Z	M6	14	PH3	500
02480600015Z	M6	15	PH3	500
02480600020Z	M6	20	PH3	500
02480600025Z	M6	25	PH3	500
02480600028Z	M6	28	PH3	3500
02480600030Z	M6	30	PH3	500
02480600035Z	M6	35	PH3	500
02480600040Z	M6	40	PH3	500
02480600045Z	M6	45	PH3	500
02480600050Z	M6	50	PH3	200



CÓDIGO	(d)	L	⊕	ENVASE
02480500015N	M5	15	PH2	1000
02480500025N	M5	25	PH2	1000
02480600015N	M6	15	PH3	500
02480600020N	M6	20	PH3	500

CÓDIGO	(d)	L	⊕	ENVASE
02480600025N	M6	25	PH3	500
02480600030N	M6	30	PH3	500
02480600035N	M6	35	PH3	500
02480600040N	M6	40	PH3	500

**0249 TORNILLO PHILIPS CON ARANDELA ESTRIADO 8.8**

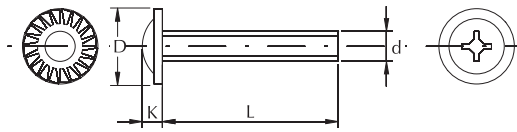

d	M6
D	15
K	4



- Tornillo con arandela estampada y estrías adherentes bajo la cabeza
- Utilizado principalmente en el ámbito de la sillería.
- Alta resistencia 8.8

CÓDIGO	(d)	L	⊕	ENVASE
02490600010N	M6	10	PH3	4000
02490600012N	M6	12	PH3	4000
02490600015N	M6	15	PH3	2500
02490600020N	M6	20	PH3	2500

CÓDIGO	(d)	L	⊕	ENVASE
02490600025N	M6	25	PH3	2500
02490600030N	M6	30	PH3	2500
02490600035N	M6	35	PH3	2000
02490600040N	M6	40	PH3	2000

Consultar disponibilidad en otras medidas.  
Consultar disponibilidad en otros recubrimientos.

**0250 TORNILLO PHILIPS CON ARANDELA ESTRIADO 6.8**

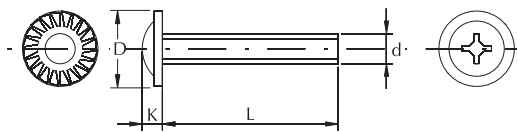

d	M6
D	15
K	4



- Tornillo con arandela estampada y estrías adherentes bajo la cabeza.
- Utilizado principalmente en el ámbito de la sillería.

CÓDIGO	(d)	L	⊕	ENVASE
02500600010N	M6	10	PH3	5000
02500600020N	M6	20	PH3	2500
02500600025N	M6	25	PH3	2500

CÓDIGO	(d)	L	⊕	ENVASE
02500600030N	M6	30	PH3	2500
02500600035N	M6	35	PH3	1500
02500600040N	M6	40	PH3	2000

Consultar disponibilidad en otras medidas.  
Consultar disponibilidad en otros recubrimientos.

d	M3	M4	M5	M6	1/8"	5/32"	3/16"	1/4"
D	5,6	7,5	9,2	11	5,4	7	8,1	11
K	1,6	2,2	2,5	3	1,7	1,9	2,5	3

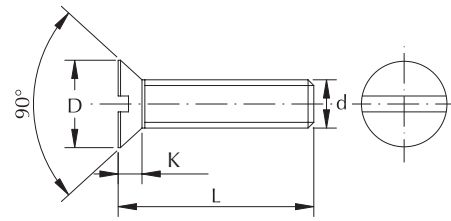

- Tornillo de cabeza avellanada con ranura.



CÓDIGO	(d)	L	ENVASE
02510300005Z	M3	5	1000
02510300006Z	M3	6	1000
02510300008Z	M3	8	1000
02510300010Z	M3	10	1000
02510300012Z	M3	12	1000
02510300015Z	M3	15	1000
02510300020Z	M3	20	1000
02510300025Z	M3	25	1000
02510300030Z	M3	30	1000
02510300035Z	M3	35	1000
02510300040Z	M3	40	1000
02510300045Z	M3	45	1000
02510400005Z	M4	5	1000
02510400006Z	M4	6	1000
02510400008Z	M4	8	1000
02510400010Z	M4	10	1000
02510400014Z	M4	14	1000
02510400015Z	M4	15	1000
02510400020Z	M4	20	1000
02510400025Z	M4	25	1000
02510400030Z	M4	30	1000
02510400035Z	M4	35	1000
02510400040Z	M4	40	1000
02510400045Z	M4	45	1000
02510400050Z	M4	50	1000
02510400060Z	M4	60	1000
02510500010Z	M5	10	1000
02510500015Z	M5	15	1000
02510500020Z	M5	20	1000
02510500025Z	M5	25	1000
02510500030Z	M5	30	1000
02510500035Z	M5	35	1000
02510500040Z	M5	40	1000
02510500045Z	M5	45	500
02510500050Z	M5	50	500
02510500060Z	M5	60	500
02510600010Z	M6	10	1000
02510600015Z	M6	15	1000
02510600020Z	M6	20	1000
02510600022Z	M6	22	500
02510600025Z	M6	25	500
02510600030Z	M6	30	500
02510600035Z	M6	35	500
02510600040Z	M6	40	200

CÓDIGO	(d)	L	ENVASE
02510600045Z	M6	45	500
02510600050Z	M6	50	500
02510600060Z	M6	60	500
02510600070Z	M6	70	200
02510800015Z	M8	15	200
02510800020Z	M8	20	200
02510800035Z	M8	35	200
02510800040Z	M8	40	200
02510800055Z	M8	55	200
02510180008Z	1/8"	8	1000
02510180010Z	1/8"	10	1000
02510180012Z	1/8"	12	1000
02510180015Z	1/8"	15	1000
02510180020Z	1/8"	20	1000
02510180025Z	1/8"	25	1000
02510180030Z	1/8"	30	1000
02510180035Z	1/8"	35	1000
02510180040Z	1/8"	40	1000
02515320006Z	5/32"	6	1000
02515320007Z	5/32"	7	1000
02515320008Z	5/32"	8	1000
02515320012Z	5/32"	12	1000
02515320025Z	5/32"	25	1000
02515320027Z	5/32"	27	1000
02515320030Z	5/32"	30	1000
02515320035Z	5/32"	35	1000
02515320040Z	5/32"	40	1000
02515320045Z	5/32"	45	1000
02515320050Z	5/32"	50	1000
02515320060Z	5/32"	60	1000
02513160020Z	3/16"	20	500
02513160030Z	3/16"	30	500
02513160035Z	3/16"	35	500
02513160040Z	3/16"	40	500
02513160045Z	3/16"	45	500
02513160050Z	3/16"	50	400
02513160060Z	3/16"	60	400
02510140015Z	1/4"	15	500
02510140025Z	1/4"	25	500
02510140050Z	1/4"	50	250
02510140055Z	1/4"	55	200
02510140060Z	1/4"	60	200
02510140080Z	1/4"	80	200

Medidas en mm.

0251 DIN 963

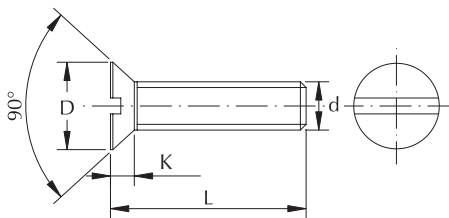

d	M4	M5
D	7,5	9,2
K	2,2	2,5



- Tornillo de cabeza avellanada con ranura.

CÓDIGO	( d )	L	ENVASE
02510400025B	M4	25	8000



CÓDIGO	( d )	L	ENVASE
02510500050L	M5	50	500



CÓDIGO	( d )	L	ENVASE
02510400008Q	M4	8	3000

0252 DIN 86

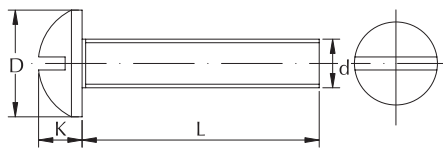

d	M4
D	7
K	3,5



CÓDIGO	( d )	L	ENVASE
02520400013L	M4	13	1000

d	M3	M4	M5	M6	M8	1/8"	5/32"	3/16"	1/4"
D	5,5	7	9	10	13	5,2	6,7	8,5	11
K	2,7	3,5	4,5	5	6	2,2	3	4	4,5

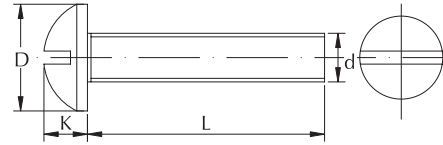

- Tornillo de cabeza redonda con ranura.



CÓDIGO	(d)	L	ENVASE
02520300005Z	M3	5	1000
02520300006Z	M3	6	1000
02520300008Z	M3	8	1000
02520300010Z	M3	10	1000
02520300012Z	M3	12	1000
02520300015Z	M3	15	1000
02520300016Z	M3	16	1000
02520300020Z	M3	20	1000
02520300025Z	M3	25	1000
02520300030Z	M3	30	1000
02520300035Z	M3	35	1000
02520400005Z	M4	5	1000
02520400006Z	M4	6	1000
02520400008Z	M4	8	1000
02520400012Z	M4	12	1000
02520400015Z	M4	15	1000
02520400017Z	M4	17	16000
02520400020Z	M4	20	1000
02520400022Z	M4	22	7700
02520400025Z	M4	25	1000
02520400030Z	M4	30	1000
02520400035Z	M4	35	1000
02520400040Z	M4	40	1000
02520400045Z	M4	45	1000
02520500007Z	M5	7	1000
02520500010Z	M5	10	1000
02520500015Z	M5	15	1000
02520500025Z	M5	25	1000
02520500030Z	M5	30	1000
02520500035Z	M5	35	1000
02520500040Z	M5	40	1000
02520500045Z	M5	45	1000
02520500050Z	M5	50	1000
02520500060Z	M5	60	1000
02520500070Z	M5	70	250
02520600010Z	M6	10	500
02520600015Z	M6	15	500
02520600020Z	M6	20	200
02520600022Z	M6	22	500
02520600025Z	M6	25	500
02520600030Z	M6	30	500
02520600035Z	M6	35	500
02520600040Z	M6	40	500
02520600045Z	M6	45	500

CÓDIGO	(d)	L	ENVASE
02520600050Z	M6	50	500
02520600060Z	M6	60	500
02520600070Z	M6	70	250
02520800015Z	M8	15	200
02520800020Z	M8	20	200
02520800025Z	M8	25	200
02520800030Z	M8	30	200
02520800035Z	M8	35	200
02520800040Z	M8	40	200
02520800045Z	M8	45	200
02520800050Z	M8	50	200
02520800055Z	M8	55	200
02520800060Z	M8	60	200
02520800065Z	M8	65	200
02520800070Z	M8	70	200
02520180025Z	1/8"	25	1000
02520180030Z	1/8"	30	1000
02520180035Z	1/8"	35	1000
02525320005Z	5/32"	5	500
02525320013Z	5/32"	13	500
02525320015Z	5/32"	15	1000
02525320020Z	5/32"	20	1000
02525320022Z	5/32"	22	7800
02525320025Z	5/32"	25	1000
02525320030Z	5/32"	30	1000
02525320035Z	5/32"	35	1000
02525320040Z	5/32"	40	500
02525320045Z	5/32"	45	500
02525320060Z	5/32"	60	500
02523160040Z	3/16"	40	500
02523160045Z	3/16"	45	500
02523160070Z	3/16"	70	500
02520140010Z	1/4"	10	500
02520140015Z	1/4"	15	500
02520140020Z	1/4"	20	500
02520140025Z	1/4"	25	500
02520140030Z	1/4"	30	500
02520140035Z	1/4"	35	500
02520140040Z	1/4"	40	500
02520140045Z	1/4"	45	500
02520140050Z	1/4"	50	250
02520140060Z	1/4"	60	250
02520140080Z	1/4"	80	250

Medidas en mm.

## 0253 DIN 84

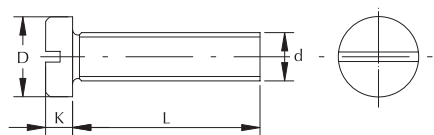

d	M3	M4	M5	M6
D	5,5	7	8,5	10
K	2	2,6	3,3	3,9



- Tornillo de cabeza cilíndrica con ranura.

CÓDIGO	(d)	L	ENVASE
02530300005Z	M3	5	1000
02530300008Z	M3	8	1000
02530300010Z	M3	10	1000
02530300012Z	M3	12	1000
02530300014Z	M3	14	1000
02530300015Z	M3	15	1000
02530300020Z	M3	20	1000
02530300025Z	M3	25	1000
02530300030Z	M3	30	1000
02530300035Z	M3	35	1000
02530300040Z	M3	40	1000
02530400006Z	M4	6	1000
02530400008Z	M4	8	1000
02530400010Z	M4	10	1000
02530400012Z	M4	12	1000
02530400014Z	M4	14	1000
02530400015Z	M4	15	1000
02530400020Z	M4	20	1000
02530400025Z	M4	25	1000
02530400030Z	M4	30	1000
02530400035Z	M4	35	1000
02530400040Z	M4	40	1000
02530400045Z	M4	45	1000
02530400050Z	M4	50	1000

CÓDIGO	(d)	L	ENVASE
02530500008Z	M5	8	500
02530500010Z	M5	10	500
02530500012Z	M5	12	1000
02530500016Z	M5	16	1000
02530500020Z	M5	20	1000
02530500025Z	M5	25	1000
02530500030Z	M5	30	1000
02530500035Z	M5	35	1000
02530500040Z	M5	40	1000
02530500045Z	M5	45	1000
02530500050Z	M5	50	500
02530600008Z	M6	8	1000
02530600010Z	M6	10	1000
02530600012Z	M6	12	500
02530600015Z	M6	15	1000
02530600016Z	M6	16	1000
02530600020Z	M6	20	1000
02530600025Z	M6	25	1000
02530600030Z	M6	30	500
02530600035Z	M6	35	500
02530600040Z	M6	40	500
02530600045Z	M6	45	500
02530600050Z	M6	50	100

## 0254 TORNILLO MARIPOSA

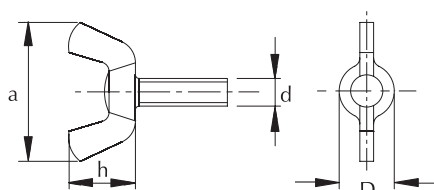

d	M4	M5	M6	M8	M10
a máx	22	22	26,8	30,3	35,3
h máx	10,5	10,5	12,9	14,6	17,3
D	9,5	9,5	11,9	13,5	15,3



- Tornillo con aletas para apriete manual.

CÓDIGO	(d)	L	ENVASE
02540400015Z	M4	15	200
02540400020Z	M4	20	200
02540400025Z	M4	25	200
02540500015Z	M5	15	200
02540500020Z	M5	20	200
02540500025Z	M5	25	200
02540500030Z	M5	30	200
02540600015Z	M6	15	200
02540600020Z	M6	20	200
02540600025Z	M6	25	200
02540600030Z	M6	30	200
02540600040Z	M6	40	200
02540600050Z	M6	50	200
02540800015Z	M8	15	100

CÓDIGO	(d)	L	ENVASE
02540800020Z	M8	20	100
02540800025Z	M8	25	200
02540800030Z	M8	30	100
02540800035Z	M8	35	200
02540800040Z	M8	40	100
02540800045Z	M8	45	100
02540800050Z	M8	50	100
02540800060Z	M8	60	100
02541000020Z	M10	20	100
02541000025Z	M10	25	100
02541000030Z	M10	30	100
02541000035Z	M10	35	100
02541000040Z	M10	40	100

Medidas en mm.

0255 TORNILLO VIOLA SIN ARANDELA

d	M4	M5	M6	M8	M10
A	11,2	14	16,5	22	26
B	7,7	10,8	14	17	19
C	2,6	3,1	4,1	4,7	6
D	1,3	1,5	1,8	2,2	2,8

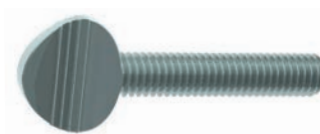
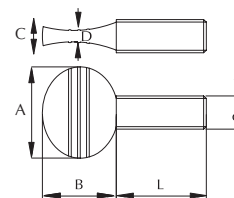

- Tornillo con cabeza de viola para apriete manual.

CÓDIGO	(d)	L	ENVASE
02550400010Z	M4	10	200
02550400015Z	M4	15	200
02550400020Z	M4	20	200
02550400025Z	M4	25	200
02550400030Z	M4	30	200
02550500010Z	M5	10	200
02550500015Z	M5	15	200
02550500020Z	M5	20	200
02550500025Z	M5	25	200
02550500030Z	M5	30	200
02550500035Z	M5	35	200
02550500040Z	M5	40	200
02550500050Z	M5	50	200
02550600010Z	M6	10	200
02550600012Z	M6	12	200
02550600015Z	M6	15	200
02550600020Z	M6	20	200
02550600025Z	M6	25	200
02550600030Z	M6	30	200
02550600035Z	M6	35	200
02550600040Z	M6	40	200

CÓDIGO	(d)	L	ENVASE
02550600045Z	M6	45	200
02550600050Z	M6	50	200
02550600060Z	M6	60	200
02550800015Z	M8	15	100
02550800020Z	M8	20	100
02550800025Z	M8	25	100
02550800030Z	M8	30	100
02550800035Z	M8	35	100
02550800040Z	M8	40	100
02550800045Z	M8	45	100
02550800050Z	M8	50	100
02550800060Z	M8	60	100
02551000015Z	M10	15	100
02551000020Z	M10	20	100
02551000025Z	M10	25	100
02551000030Z	M10	30	100
02551000035Z	M10	35	100
02551000040Z	M10	40	100
02551000045Z	M10	45	100
02551000050Z	M10	50	100
02551000060Z	M10	60	100

0256 TORNILLO CASCABEL CON TUERCA Y ARANDELA

d	3/8"
D	13
K	11
t	4

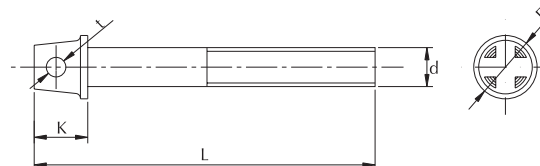

- Tornillo cilíndrico con agujeros para ensamblaje de muebles.
- Incluye tuerca de embutir y arandela.



CÓDIGO	(d)	L	ENVASE
02560380030B	3/8"	30	200
02560380040B	3/8"	40	200
02560380050B	3/8"	50	200
02560380060B	3/8"	60	200
02560380070B	3/8"	70	200
02560380080B	3/8"	80	200

CÓDIGO	(d)	L	ENVASE
02560380090B	3/8"	90	100
02560380100B	3/8"	100	100
02560380120B	3/8"	120	100
02560380130B	3/8"	130	100
02560380140B	3/8"	140	100

0257 TORNILLO CASCABEL SIN TUERCA Y CON ARANDELA

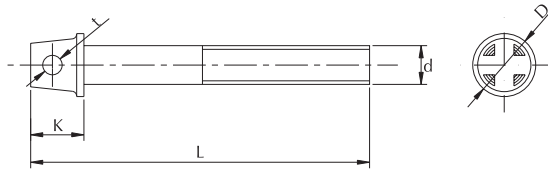

d	3/8"
D	13
K	11
t	4



- Tornillo cilíndrico con agujeros para ensamblaje de muebles.
- Incluye arandela.

CÓDIGO	(d)	L	ENVASE
02570380030B	3/8"	30	200
02570380040B	3/8"	40	200
02570380050B	3/8"	50	200
02570380060B	3/8"	60	200
02570380070B	3/8"	70	200
02570380080B	3/8"	80	200

CÓDIGO	(d)	L	ENVASE
02570380090B	3/8"	90	100
02570380100B	3/8"	100	100
02570380120B	3/8"	120	100
02570380130B	3/8"	130	100
02570380140B	3/8"	140	100

0258 TORNILLO CASCABEL SIN TUERCA Y SIN ARANDELA

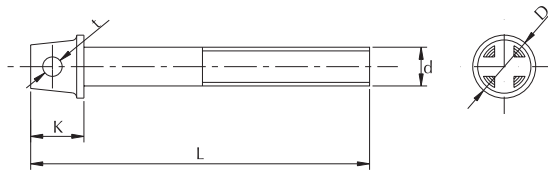

d	1/4"	3/8"
D	11	13
K	10	11
t	3,5	4



- Tornillo cilíndrico con agujeros para ensamblaje de muebles.

CÓDIGO	(d)	L	ENVASE
02580140030B	1/4"	30	500
02580140035B	1/4"	35	500
02580140040B	1/4"	40	500
02580140045B	1/4"	45	500
02580140060B	1/4"	60	200
02580140070B	1/4"	70	200
02580140080B	1/4"	80	200
02580140090B	1/4"	90	200
02580140100B	1/4"	100	200
02580140110B	1/4"	110	100
02580380030B	3/8"	30	200

CÓDIGO	(d)	L	ENVASE
02580380040B	3/8"	40	200
02580380050B	3/8"	50	200
02580380060B	3/8"	60	200
02580380070B	3/8"	70	200
02580380080B	3/8"	80	200
02580380090B	3/8"	90	100
02580380100B	3/8"	100	100
02580380120B	3/8"	120	100
02580380130B	3/8"	130	100
02580380140B	3/8"	140	100



0259 TORNILLO CAMA CON TUERCA Y ARANDELA

d	3/8"
D	18
K	5
S	15

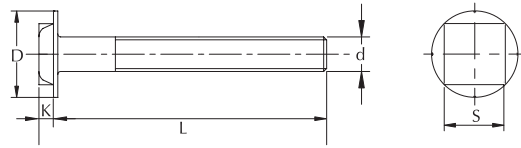

- Tornillo de cabeza cuadrada para ensamblaje de muebles.
- Incluye tuerca cuadrada y arandela.

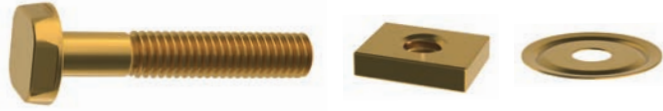

CÓDIGO	(d)	L	ENVASE
02590380040B	3/8"	40	100
02590380050B	3/8"	50	100
02590380060B	3/8"	60	100
02590380070B	3/8"	70	100
02590380080B	3/8"	80	100

CÓDIGO	(d)	L	ENVASE
02590380090B	3/8"	90	100
02590380100B	3/8"	100	100
02590380110B	3/8"	110	100
02590380130B	3/8"	130	100
02590380140B	3/8"	140	100

0260 TORNILLO CAMA SIN TUERCA Y CON ARANDELA

d	3/8"
D	18
K	5
S	15

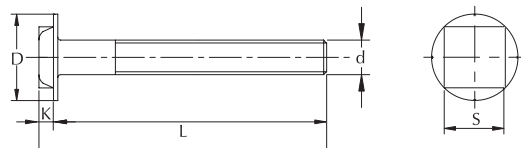

- Tornillo de cabeza cuadrada para ensamblaje de muebles.
- Incluye arandela.



CÓDIGO	(d)	L	ENVASE
02600380040B	3/8"	40	100
02600380050B	3/8"	50	100
02600380060B	3/8"	60	100
02600380070B	3/8"	70	100
02600380080B	3/8"	80	100

CÓDIGO	(d)	L	ENVASE
02600380090B	3/8"	90	100
02600380100B	3/8"	100	100
02600380110B	3/8"	110	100
02600380130B	3/8"	130	100
02600380140B	3/8"	140	100

0261 TORNILLO CAMA SIN TUERCA Y SIN ARANDELA

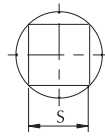
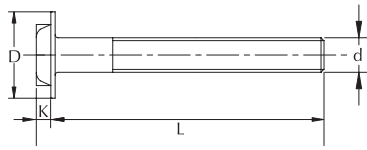

d	3/8"
D	18
K	5
S	15



- Tornillo de cabeza cuadrada para ensamblaje de muebles.

CÓDIGO	(d)	L	ENVASE
02610380040B	3/8"	40	100
02610380050B	3/8"	50	100
02610380060B	3/8"	60	100
02610380070B	3/8"	70	100
02610380080B	3/8"	80	100
02610380090B	3/8"	90	100

CÓDIGO	(d)	L	ENVASE
02610380100B	3/8"	100	100
02610380110B	3/8"	110	100
02610380120B	3/8"	120	100
02610380130B	3/8"	130	100
02610380140B	3/8"	140	100



**TORNILLOS  
ROSCA MÉTRICA  
TRILOBULAR**

**03**

## 0301 DIN 7500 FORMA M POZI

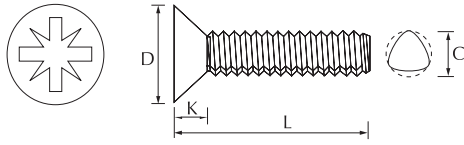

d	M2,5	M3	M3,5	M4	M5	M6	M8
POZI	1	1	2	2	2	3	4
C	2,57	3,07	3,58	4,08	5,09	6,1	8,13
D	4,7	5,6	6,5	7,5	9,2	11	14,5
K	1,5	1,65	1,93	2,2	2,5	3	4

- Tornillo métrico trilobular de cabeza avellanada y huella pozidrive.
- Función autorroscante en aluminio y otros metales maleables.
- Con tratamiento térmico.

CÓDIGO	(d)	L	☼	ENVASE
03010250006Z	M2,5	6	PZ1	1000
03010250008Z	M2,5	8	PZ1	1000
03010250010Z	M2,5	10	PZ1	1000
03010300006Z	M3	6	PZ1	1000
03010300008Z	M3	8	PZ1	1000
03010300010Z	M3	10	PZ1	1000
03010300012Z	M3	12	PZ1	1000
03010300016Z	M3	16	PZ1	1000
03010300020Z	M3	20	PZ1	1000
03010300025Z	M3	25	PZ1	1000
03010350006Z	M3,5	6	PZ2	1000
03010350008Z	M3,5	8	PZ2	1000
03010350010Z	M3,5	10	PZ2	1000
03010350012Z	M3,5	12	PZ2	1000
03010350016Z	M3,5	16	PZ2	1000
03010400006Z	M4	6	PZ2	1000
03010400008Z	M4	8	PZ2	1000
03010400010Z	M4	10	PZ2	1000
03010400012Z	M4	12	PZ2	1000
03010400016Z	M4	16	PZ2	1000
03010400020Z	M4	20	PZ2	1000
03010400025Z	M4	25	PZ2	1000
03010400030Z	M4	30	PZ2	1000
03010500008Z	M5	8	PZ2	1000

CÓDIGO	(d)	L	☼	ENVASE
03010500010Z	M5	10	PZ2	1000
03010500012Z	M5	12	PZ2	1000
03010500016Z	M5	16	PZ2	1000
03010500020Z	M5	20	PZ2	1000
03010500025Z	M5	25	PZ2	1000
03010500030Z	M5	30	PZ2	500
03010500040Z	M5	40	PZ2	500
03010600012Z	M6	12	PZ3	1000
03010600016Z	M6	16	PZ3	1000
03010600020Z	M6	20	PZ3	500
03010600025Z	M6	25	PZ3	500
03010600030Z	M6	30	PZ3	250
03010600035Z	M6	35	PZ3	250
03010600040Z	M6	40	PZ3	250
03010600045Z	M6	45	PZ3	250
03010600050Z	M6	50	PZ3	250
03010800012Z	M8	12	PZ4	500
03010800016Z	M8	16	PZ4	500
03010800020Z	M8	20	PZ4	500
03010800025Z	M8	25	PZ4	250
03010800030Z	M8	30	PZ4	250
03010800040Z	M8	40	PZ4	250
03010800050Z	M8	50	PZ4	200

Consultar cantidad mínima de servicio.

0302 DIN 7500 FORMA C POZI

d	M2	M2,5	M3	M3,5	M4	M5	M6	M8
POZI	1	1	1	2	2	2	3	4
C	2,06	2,57	3,07	3,58	4,08	5,09	6,1	8,13
D	4	5	6	7	8	10	12	16
K	1,72	2,12	2,52	2,82	3,25	3,95	4,75	6,15

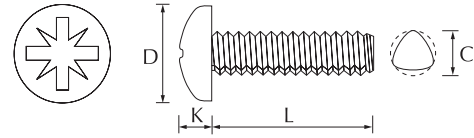

- Tornillo métrico trilobular de cabeza alomada y huella pozidrive.
- Función autorroscante en aluminio y otros metales maleables.
- Con tratamiento térmico.

CÓDIGO	(d)	L	+	ENVASE
03020200005Z	M2	5	PZ1	1000
03020200006Z	M2	6	PZ1	1000
03020200008Z	M2	8	PZ1	1000
03020200010Z	M2	10	PZ1	1000
03020250005Z	M2,5	5	PZ1	1000
03020250006Z	M2,5	6	PZ1	1000
03020250008Z	M2,5	8	PZ1	1000
03020250010Z	M2,5	10	PZ1	1000
03020250014Z	M2,5	14	PZ1	1000
03020250016Z	M2,5	16	PZ1	1000
03020300005Z	M3	5	PZ1	1000
03020300006Z	M3	6	PZ1	1000
03020300008Z	M3	8	PZ1	1000
03020300010Z	M3	10	PZ1	1000
03020300012Z	M3	12	PZ1	1000
03020300016Z	M3	16	PZ1	1000
03020300020Z	M3	20	PZ1	1000
03020300025Z	M3	25	PZ1	1000
03020300030Z	M3	30	PZ1	1000
03020350006Z	M3,5	6	PZ2	1000
03020350008Z	M3,5	8	PZ2	1000
03020350010Z	M3,5	10	PZ2	1000
03020350012Z	M3,5	12	PZ2	1000
03020350016Z	M3,5	16	PZ2	1000
03020350020Z	M3,5	20	PZ2	1000
03020350025Z	M3,5	25	PZ2	1000
03020400006Z	M4	6	PZ2	1000
03020400008Z	M4	8	PZ2	1000
03020400010Z	M4	10	PZ2	1000

CÓDIGO	(d)	L	+	ENVASE
03020400012Z	M4	12	PZ2	1000
03020400016Z	M4	16	PZ2	1000
03020400020Z	M4	20	PZ2	1000
03020400025Z	M4	25	PZ2	1000
03020400030Z	M4	30	PZ2	500
03020400035Z	M4	35	PZ2	500
03020400040Z	M4	40	PZ2	500
03020500006Z	M5	6	PZ2	1000
03020500008Z	M5	8	PZ2	1000
03020500010Z	M5	10	PZ2	1000
03020500012Z	M5	12	PZ2	1000
03020500016Z	M5	16	PZ2	1000
03020500020Z	M5	20	PZ2	500
03020500025Z	M5	25	PZ2	500
03020500030Z	M5	30	PZ2	500
03020500035Z	M5	35	PZ2	500
03020500040Z	M5	40	PZ2	250
03020600008Z	M6	8	PZ3	1000
03020600010Z	M6	10	PZ3	1000
03020600012Z	M6	12	PZ3	500
03020600016Z	M6	16	PZ3	500
03020600020Z	M6	20	PZ3	500
03020600025Z	M6	25	PZ3	500
03020600030Z	M6	30	PZ3	250
03020600035Z	M6	35	PZ3	250
03020600040Z	M6	40	PZ3	250
03020600050Z	M6	50	PZ3	250
03020800020Z	M8	20	PZ4	250

Consultar cantidad mínima de servicio.

## 0303 DIN 7500 FORMA M STAR

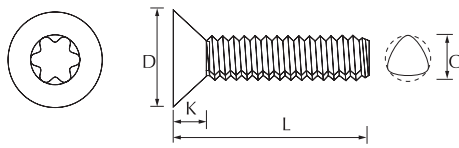

d	M2	M2,5	M3	M3,5	M4	M5	M6	M8
STAR	T6	T8	T10	T15	T20	T25	T30	T40
C	2,06	2,57	3,07	3,58	4,08	5,09	6,1	8,13
D	3,8	4,7	5,6	6,5	7,5	9,2	11	14,5
K	1,2	1,5	1,65	1,93	2,2	2,5	3	4

- Tornillo métrico trilobular de cabeza avellanada y huella hexalobular.
- Función autorroscante en aluminio y otros metales maleables.
- Huella hexalobular que mejora el agarre de la punta de atornillar.
- Con tratamiento térmico.

CÓDIGO	(d)	L	☼	ENVASE
03030200006Z	M2	6	T60	1000
03030250006Z	M2,5	6	T80	1000
03030250008Z	M2,5	8	T80	1000
03030300004Z	M3	4	T10	1000
03030300005Z	M3	5	T10	1000
03030300006Z	M3	6	T10	1000
03030300008Z	M3	8	T10	1000
03030300010Z	M3	10	T10	1000
03030300012Z	M3	12	T10	1000
03030300025Z	M3	25	T10	1000
03030300030Z	M3	30	T10	1000
03030350008Z	M3,5	8	T15	1000
03030400006Z	M4	6	T20	1000
03030400008Z	M4	8	T20	1000
03030400010Z	M4	10	T20	1000
03030400012Z	M4	12	T20	1000
03030400016Z	M4	16	T20	1000
03030400020Z	M4	20	T20	1000
03030400030Z	M4	30	T20	500

CÓDIGO	(d)	L	☼	ENVASE
03030400035Z	M4	35	T20	500
03030500008Z	M5	8	T25	1000
03030500010Z	M5	10	T25	1000
03030500012Z	M5	12	T25	1000
03030500016Z	M5	16	T25	1000
03030500020Z	M5	20	T25	1000
03030500025Z	M5	25	T25	1000
03030500030Z	M5	30	T25	250
03030600010Z	M6	10	T30	500
03030600012Z	M6	12	T30	1000
03030600016Z	M6	16	T30	1000
03030600020Z	M6	20	T30	500
03030600025Z	M6	25	T30	500
03030600030Z	M6	30	T30	250
03030600040Z	M6	40	T30	250
03030600050Z	M6	50	T30	250
03030800016Z	M8	16	T40	250
03030800020Z	M8	20	T40	125

Consultar cantidad mínima de servicio.

0304 DIN 7500 FORMA C STAR

d	M2	M2,5	M3	M3,5	M4	M5	M6
STAR	T6	T8	T10	T15	T20	T25	T30
C	2,06	2,57	3,07	3,58	4,08	5,09	6,1
D	4	5	6	7	8	10	12
K	1,72	2,12	2,52	2,82	3,25	3,95	4,75

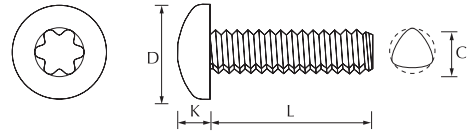

- Tornillo métrico trilobular de cabeza alomada y huella hexalobular.
- Función autorroscante en aluminio y otros metales maleables.
- Huella hexalobular que mejora el agarre de la punta de atornillar.
- Con tratamiento térmico.



CÓDIGO	(d)	L	★	ENVASE
03040200006Z	M2	6	T60	1000
03040250004Z	M2,5	4	T80	1000
03040250005Z	M2,5	5	T80	1000
03040250006Z	M2,5	6	T80	1000
03040250008Z	M2,5	8	T80	1000
03040250010Z	M2,5	10	T80	1000
03040250012Z	M2,5	12	T80	1000
03040250016Z	M2,5	16	T80	1000
03040300004Z	M3	4	T10	1000
03040300005Z	M3	5	T10	1000
03040300006Z	M3	6	T10	1000
03040300008Z	M3	8	T10	1000
03040300010Z	M3	10	T10	1000
03040300012Z	M3	12	T10	1000
03040300016Z	M3	16	T10	1000
03040300020Z	M3	20	T10	1000
03040300025Z	M3	25	T10	1000
03040300030Z	M3	30	T10	1000
03040350006Z	M3,5	6	T15	1000
03040350008Z	M3,5	8	T15	1000
03040350010Z	M3,5	10	T15	1000
03040350012Z	M3,5	12	T15	1000
03040400006Z	M4	6	T20	1000
03040400008Z	M4	8	T20	1000
03040400010Z	M4	10	T20	1000
03040400012Z	M4	12	T20	1000

CÓDIGO	(d)	L	★	ENVASE
03040400014Z	M4	14	T20	1000
03040400016Z	M4	16	T20	1000
03040400020Z	M4	20	T20	1000
03040400025Z	M4	25	T20	1000
03040400030Z	M4	30	T20	1000
03040400035Z	M4	35	T20	250
03040500006Z	M5	6	T25	1000
03040500008Z	M5	8	T25	1000
03040500010Z	M5	10	T25	1000
03040500012Z	M5	12	T25	1000
03040500016Z	M5	16	T25	1000
03040500018Z	M5	18	T25	250
03040500020Z	M5	20	T25	500
03040500025Z	M5	25	T25	500
03040500030Z	M5	30	T25	500
03040500040Z	M5	40	T25	250
03040600008Z	M6	8	T30	1000
03040600010Z	M6	10	T30	1000
03040600012Z	M6	12	T30	500
03040600016Z	M6	16	T30	500
03040600020Z	M6	20	T30	500
03040600025Z	M6	25	T30	500
03040600030Z	M6	30	T30	250
03040600035Z	M6	35	T30	250
03040600040Z	M6	40	T30	250

Consultar cantidad mínima de servicio.

**Respuesta instantánea.  
Soluciones de calidad.  
Entregas en 24 / 48 horas.**







TORNILLOS  
ROSCA PLÁSTICO

04

0401 TORNILLO ROSCA PLÁSTICO 30° CABEZA PLANA POZI

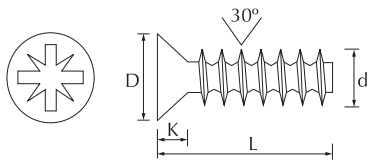

d	2,2	2,5	3	3,5	4	5	6
POZI	1	1	1	2	2	2	2
D	3,8	4,7	5,5	7,3	8,4	9,3	11,3
K	1,3	1,75	2,05	2,8	3,25	3,4	3,8

- Tornillo rosca plástico para todo tipo de termoplásticos.
- Cuenta con un paso de rosca óptimo para un agarre firme a la pieza, incrementando la fuerza de extracción y reduciendo las posibles grietas y tensiones en el alojamiento.
- Con tratamiento térmico.

CÓDIGO	(d)	L	+	ENVASE
04010220005Z	2,2	5	PZ1	1000
04010220006Z	2,2	6	PZ1	1000
04010220008Z	2,2	8	PZ1	1000
04010220010Z	2,2	10	PZ1	1000
04010250005Z	2,5	5	PZ1	1000
04010250006Z	2,5	6	PZ1	1000
04010250008Z	2,5	8	PZ1	1000
04010250010Z	2,5	10	PZ1	1000
04010250012Z	2,5	12	PZ1	1000
04010250014Z	2,5	14	PZ1	1000
04010250016Z	2,5	16	PZ1	1000
04010250018Z	2,5	18	PZ1	1000
04010300006Z	3	6	PZ1	1000
04010300008Z	3	8	PZ1	1000
04010300010Z	3	10	PZ1	1000
04010300012Z	3	12	PZ1	1000
04010300014Z	3	14	PZ1	1000
04010300016Z	3	16	PZ1	1000
04010300018Z	3	18	PZ1	1000
04010300020Z	3	20	PZ1	1000
04010300025Z	3	25	PZ1	1000
04010350008Z	3,5	8	PZ2	1000
04010350010Z	3,5	10	PZ2	1000
04010350012Z	3,5	12	PZ2	1000
04010350014Z	3,5	14	PZ2	1000

CÓDIGO	(d)	L	+	ENVASE
04010350016Z	3,5	16	PZ2	1000
04010350020Z	3,5	20	PZ2	1000
04010350025Z	3,5	25	PZ2	1000
04010400008Z	4	8	PZ2	1000
04010400010Z	4	10	PZ2	1000
04010400012Z	4	12	PZ2	1000
04010400014Z	4	14	PZ2	1000
04010400016Z	4	16	PZ2	1000
04010400018Z	4	18	PZ2	1000
04010400020Z	4	20	PZ2	1000
04010400025Z	4	25	PZ2	1000
04010400030Z	4	30	PZ2	1000
04010500010Z	5	10	PZ2	1000
04010500012Z	5	12	PZ2	1000
04010500014Z	5	14	PZ2	1000
04010500016Z	5	16	PZ2	1000
04010500018Z	5	18	PZ2	1000
04010500020Z	5	20	PZ2	1000
04010500025Z	5	25	PZ2	1000
04010500030Z	5	30	PZ2	500
04010600012Z	6	12	PZ2	1000
04010600016Z	6	16	PZ2	1000
04010600020Z	6	20	PZ2	500
04010600025Z	6	25	PZ2	500
04010600030Z	6	30	PZ2	500

Consultar cantidad mínima de servicio.



## 0402 TORNILLO ROSCA PLÁSTICO 30° CABEZA CON ARANDELA POZI

d	2,2	2,5	3	3,5	4	5	6
POZI	1	1	1	2	2	2	3
D	4,4	5	6	7	8	10	12
K	1,6	1,8	2,1	2,4	2,5	3,2	4

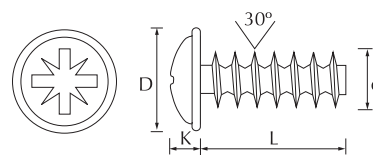

- Tornillo rosca plástico para todo tipo de termoplásticos.
- Cuenta con un paso de rosca óptimo para un agarre firme a la pieza, incrementando la fuerza de extracción y reduciendo las posibles grietas y tensiones en el alojamiento.
- Con tratamiento térmico.



CÓDIGO	(d)	L	+	ENVASE
04020220005Z	2,2	5	PZ1	1000
04020220006Z	2,2	6	PZ1	1000
04020220008Z	2,2	8	PZ1	1000
04020220010Z	2,2	10	PZ1	1000
04020250005Z	2,5	5	PZ1	1000
04020250006Z	2,5	6	PZ1	1000
04020250008Z	2,5	8	PZ1	1000
04020250010Z	2,5	10	PZ1	1000
04020250012Z	2,5	12	PZ1	1000
04020300006Z	3	6	PZ1	1000
04020300008Z	3	8	PZ1	1000
04020300010Z	3	10	PZ1	1000
04020300012Z	3	12	PZ1	1000
04020300014Z	3	14	PZ1	1000
04020300016Z	3	16	PZ1	1000
04020300020Z	3	20	PZ1	1000
04020350008Z	3,5	8	PZ2	1000
04020350010Z	3,5	10	PZ2	1000
04020350012Z	3,5	12	PZ2	1000
04020350014Z	3,5	14	PZ2	1000
04020350016Z	3,5	16	PZ2	1000
04020350020Z	3,5	20	PZ2	1000

CÓDIGO	(d)	L	+	ENVASE
04020350025Z	3,5	25	PZ2	1000
04020400008Z	4	8	PZ2	1000
04020400010Z	4	10	PZ2	1000
04020400012Z	4	12	PZ2	1000
04020400014Z	4	14	PZ2	1000
04020400016Z	4	16	PZ2	1000
04020400018Z	4	18	PZ2	1000
04020400020Z	4	20	PZ2	1000
04020400025Z	4	25	PZ2	1000
04020400030Z	4	30	PZ2	500
04020500012Z	5	12	PZ2	1000
04020500014Z	5	14	PZ2	1000
04020500016Z	5	16	PZ2	1000
04020500018Z	5	18	PZ2	1000
04020500020Z	5	20	PZ2	1000
04020500025Z	5	25	PZ2	500
04020500030Z	5	30	PZ2	500
04020600012Z	6	12	PZ3	1000
04020600016Z	6	16	PZ3	500
04020600020Z	6	20	PZ3	500
04020600025Z	6	25	PZ3	500
04020600030Z	6	30	PZ3	500

Consultar cantidad mínima de servicio.

0403 TORNILLO ROSCA PLÁSTICO 30° CABEZA ALOMADA POZI

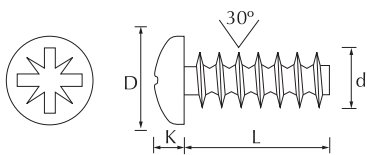

d	2,2	2,5	3	3,5	4	5	6
POZI	1	1	1	2	2	2	3
D	3,9	4,4	5,3	6,1	7	8,8	10,5
K	1,5	1,7	2	2,5	2,7	3,4	4

- Tornillo rosca plástico para todo tipo de termoplásticos.
- Cuenta con un paso de rosca óptimo para un agarre firme a la pieza, incrementando la fuerza de extracción y reduciendo las posibles grietas y tensiones en el alojamiento.
- Con tratamiento térmico.

CÓDIGO	(d)	L	+	ENVASE
04030220005Z	2,2	5	PZ1	1000
04030220006Z	2,2	6	PZ1	1000
04030220008Z	2,2	8	PZ1	1000
04030220010Z	2,2	10	PZ1	1000
04030250005Z	2,5	5	PZ1	1000
04030250006Z	2,5	6	PZ1	1000
04030250008Z	2,5	8	PZ1	1000
04030250010Z	2,5	10	PZ1	1000
04030250012Z	2,5	12	PZ1	1000
04030250014Z	2,5	14	PZ1	1000
04030250016Z	2,5	16	PZ1	1000
04030250018Z	2,5	18	PZ1	1000
04030300006Z	3	6	PZ1	1000
04030300008Z	3	8	PZ1	1000
04030300010Z	3	10	PZ1	1000
04030300012Z	3	12	PZ1	1000
04030300014Z	3	14	PZ1	1000
04030300016Z	3	16	PZ1	1000
04030300018Z	3	18	PZ1	1000
04030300020Z	3	20	PZ1	1000
04030300025Z	3	25	PZ1	1000
04030300030Z	3	30	PZ1	1000
04030350008Z	3,5	8	PZ2	1000
04030350010Z	3,5	10	PZ2	1000
04030350012Z	3,5	12	PZ2	1000
04030350014Z	3,5	14	PZ2	1000
04030350016Z	3,5	16	PZ2	1000
04030350018Z	3,5	18	PZ2	1000

CÓDIGO	(d)	L	+	ENVASE
04030350020Z	3,5	20	PZ2	1000
04030350025Z	3,5	25	PZ2	1000
04030350030Z	3,5	30	PZ2	1000
04030400008Z	4	8	PZ2	1000
04030400010Z	4	10	PZ2	1000
04030400012Z	4	12	PZ2	1000
04030400014Z	4	14	PZ2	1000
04030400016Z	4	16	PZ2	1000
04030400018Z	4	18	PZ2	1000
04030400020Z	4	20	PZ2	1000
04030400025Z	4	25	PZ2	1000
04030400030Z	4	30	PZ2	500
04030400040Z	4	40	PZ2	1000
04030500010Z	5	10	PZ2	1000
04030500012Z	5	12	PZ2	1000
04030500014Z	5	14	PZ2	1000
04030500016Z	5	16	PZ2	1000
04030500018Z	5	18	PZ2	1000
04030500020Z	5	20	PZ2	1000
04030500025Z	5	25	PZ2	500
04030500030Z	5	30	PZ2	500
04030500035Z	5	35	PZ2	500
04030600012Z	6	12	PZ3	1000
04030600016Z	6	16	PZ3	500
04030600020Z	6	20	PZ3	500
04030600025Z	6	25	PZ3	500
04030600030Z	6	30	PZ3	500
04030600035Z	6	35	PZ3	500

Consultar cantidad mínima de servicio.



0404 TORNILLO ROSCA PLÁSTICO 30° CABEZA PLANA STAR

d	2,2	2,5	3	3,5	4	5
STAR	T6	T8	T8	T15	T20	T20
D	3,8	4,7	5,5	7,3	8,4	9,3
K	1,3	1,75	2,05	2,8	3,25	3,4

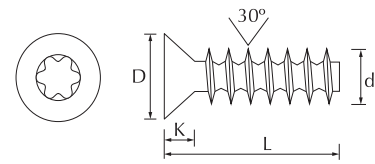

- Tornillo rosca plástico para todo tipo de termoplásticos.
- Cuenta con un paso de rosca óptimo para un agarre firme a la pieza, incrementando la fuerza de extracción y reduciendo las posibles grietas y tensiones en el alojamiento.
- Huella hexalobular que mejora el agarre de la punta de atornillar.
- Con tratamiento térmico.



CÓDIGO	(d)	L	+	ENVASE
04040220006Z	2,2	6	T60	1000
04040250006Z	2,5	6	T80	1000
04040250008Z	2,5	8	T80	1000
04040300008Z	3	8	T80	1000
04040300010Z	3	10	T80	1000
04040300012Z	3	12	T80	1000
04040300016Z	3	16	T80	1000
04040300020Z	3	20	T80	1000
04040350010Z	3,5	10	T15	1000

CÓDIGO	(d)	L	+	ENVASE
04040350012Z	3,5	12	T15	1000
04040350016Z	3,5	16	T15	1000
04040350020Z	3,5	20	T15	1000
04040400010Z	4	10	T20	1000
04040400012Z	4	12	T20	1000
04040400016Z	4	16	T20	1000
04040400020Z	4	20	T20	1000
04040500016Z	5	16	T20	500

Consultar cantidad mínima de servicio.

0405 TORNILLO ROSCA PLÁSTICO 30° CABEZA CON ARANDELA STAR

d	2,5	3	3,5	4	5	6
STAR	T6	T10	T10	T20	T20	T25
D	5	6	7	8	10	12
K	1,8	2,1	2,4	2,5	3,2	4

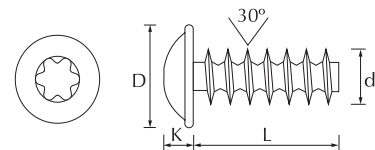

- Tornillo rosca plástico para todo tipo de termoplásticos.
- Cuenta con un paso de rosca óptimo para un agarre firme a la pieza, incrementando la fuerza de extracción y reduciendo las posibles grietas y tensiones en el alojamiento.
- Huella hexalobular que mejora el agarre de la punta de atornillar.
- Con tratamiento térmico.



CÓDIGO	(d)	L	+	ENVASE
04050250006Z	2,5	6	T60	1000
04050250008Z	2,5	8	T60	1000
04050300006Z	3	6	T10	1000
04050300008Z	3	8	T10	1000
04050300010Z	3	10	T10	1000
04050300012Z	3	12	T10	1000
04050300014Z	3	14	T10	1000
04050300016Z	3	16	T10	1000
04050300018Z	3	18	T10	1000
04050300020Z	3	20	T10	1000
04050300025Z	3	25	T10	1000
04050350008Z	3,5	8	T10	1000
04050350010Z	3,5	10	T10	1000
04050350012Z	3,5	12	T10	1000
04050350014Z	3,5	14	T10	1000
04050350016Z	3,5	16	T10	1000
04050350018Z	3,5	18	T10	1000
04050350020Z	3,5	20	T10	1000
04050350025Z	3,5	25	T10	1000
04050400008Z	4	8	T20	1000
04050400010Z	4	10	T20	1000
04050400012Z	4	12	T20	1000

CÓDIGO	(d)	L	+	ENVASE
04050400014Z	4	14	T20	1000
04050400016Z	4	16	T20	1000
04050400018Z	4	18	T20	1000
04050400020Z	4	20	T20	1000
04050400025Z	4	25	T20	1000
04050400030Z	4	30	T20	1000
04050500008Z	5	8	T20	1000
04050500010Z	5	10	T20	1000
04050500012Z	5	12	T20	1000
04050500014Z	5	14	T20	1000
04050500016Z	5	16	T20	1000
04050500018Z	5	18	T20	1000
04050500020Z	5	20	T20	1000
04050500025Z	5	25	T20	500
04050500030Z	5	30	T20	500
04050600012Z	6	12	T25	500
04050600014Z	6	14	T25	500
04050600016Z	6	16	T25	500
04050600018Z	6	18	T25	500
04050600020Z	6	20	T25	500
04050600025Z	6	25	T25	500
04050600030Z	6	30	T25	500

Consultar cantidad mínima de servicio.

Medidas en mm. Puntas de atornillar disponibles en página 272.

0406 TORNILLO ROSCA PLÁSTICO 30° CABEZA ALOMADA STAR

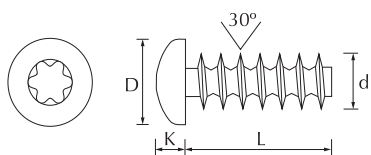

d	2,2	2,5	3	3,5	4	5	6
STAR	T6	T7	T10	T10	T20	T20	T25
D	4	4,2	5,6	6,9	7,5	8,2	10,8
K	1,5	1,6	2,1	2,3	2,6	2,9	3,95



- Tornillo rosca plástico para todo tipo de termoplásticos.
- Cuenta con un paso de rosca óptimo para un agarre firme a la pieza, incrementando la fuerza de extracción y reduciendo las posibles grietas y tensiones en el alojamiento.
- Huella hexalobular que mejora el agarre de la punta de atornillar.
- Con tratamiento térmico.

CÓDIGO	(d)	L	☼	ENVASE
04060220005Z	2,2	5	T60	1000
04060220006Z	2,2	6	T60	1000
04060220008Z	2,2	8	T60	1000
04060250005Z	2,5	5	T70	1000
04060250006Z	2,5	6	T70	1000
04060250008Z	2,5	8	T70	1000
04060250010Z	2,5	10	T70	1000
04060250012Z	2,5	12	T70	1000
04060250014Z	2,5	14	T70	1000
04060250016Z	2,5	16	T70	1000
04060300006Z	3	6	T10	1000
04060300008Z	3	8	T10	1000
04060300010Z	3	10	T10	1000
04060300012Z	3	12	T10	1000
04060300014Z	3	14	T10	1000
04060300016Z	3	16	T10	1000
04060300018Z	3	18	T10	1000
04060300020Z	3	20	T10	1000
04060300025Z	3	25	T10	1000
04060300030Z	3	30	T10	500
04060350008Z	3,5	8	T10	1000
04060350010Z	3,5	10	T10	1000
04060350012Z	3,5	12	T10	1000

CÓDIGO	(d)	L	☼	ENVASE
04060350014Z	3,5	14	T10	1000
04060350016Z	3,5	16	T10	1000
04060350018Z	3,5	18	T10	1000
04060350020Z	3,5	20	T10	1000
04060350025Z	3,5	25	T10	1000
04060400008Z	4	8	T20	1000
04060400010Z	4	10	T20	1000
04060400012Z	4	12	T20	1000
04060400014Z	4	14	T20	1000
04060400016Z	4	16	T20	1000
04060400018Z	4	18	T20	1000
04060400020Z	4	20	T20	1000
04060400025Z	4	25	T20	1000
04060400030Z	4	30	T20	500
04060500012Z	5	12	T20	1000
04060500014Z	5	14	T20	1000
04060500016Z	5	16	T20	500
04060500020Z	5	20	T20	500
04060500025Z	5	25	T20	500
04060600012Z	6	12	T25	500
04060600016Z	6	16	T25	500
04060600025Z	6	25	T25	500

Consultar cantidad mínima de servicio.

## 0407 TORNILLO ROSCA PLÁSTICO 45° CABEZA PLANA POZI TRILOBULAR

d	2,5	3	3,5	4	5
POZI	1	1	1	2	2
C	2,55	3,05	3,55	4,06	5,06
D	4,4	5,5	6,3	7,35	8,4
K	1,3	1,5	1,65	1,9	2,2

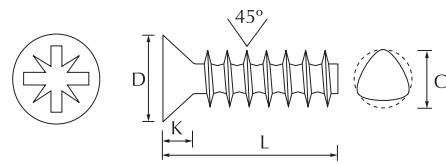

- Tornillo rosca plástico de 45° permite un agarre profundo al material plástico.
- El cuerpo trilobular hace posible que el material desplazado se recupere al enfriar, reduciendo así las tensiones radiales y disminuyendo el riesgo de grietas en el alojamiento.
- Con tratamiento térmico.

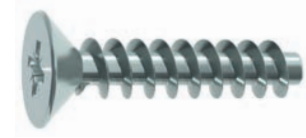

CÓDIGO	(d)	L	+	ENVASE
04070250006Z	2,5	6	PZ1	1000
04070250008Z	2,5	8	PZ1	1000
04070250010Z	2,5	10	PZ1	1000
04070300006Z	3	6	PZ1	1000
04070300008Z	3	8	PZ1	1000
04070300010Z	3	10	PZ1	1000
04070300012Z	3	12	PZ1	1000
04070300016Z	3	16	PZ1	1000
04070300020Z	3	20	PZ1	1000
04070300025Z	3	25	PZ1	1000
04070350006Z	3,5	6	PZ1	1000
04070350008Z	3,5	8	PZ1	1000
04070350010Z	3,5	10	PZ1	1000
04070350012Z	3,5	12	PZ1	1000

CÓDIGO	(d)	L	+	ENVASE
04070350016Z	3,5	16	PZ1	1000
04070350020Z	3,5	20	PZ1	1000
04070400008Z	4	8	PZ2	1000
04070400010Z	4	10	PZ2	1000
04070400012Z	4	12	PZ2	1000
04070400016Z	4	16	PZ2	1000
04070400020Z	4	20	PZ2	1000
04070400025Z	4	25	PZ2	1000
04070500010Z	5	10	PZ2	1000
04070500012Z	5	12	PZ2	1000
04070500016Z	5	16	PZ2	1000
04070500020Z	5	20	PZ2	1000
04070500025Z	5	25	PZ2	1000
04070500030Z	5	30	PZ2	500

Consultar cantidad mínima de servicio.

## 0408 TORNILLO ROSCA PLÁSTICO 45° CABEZA CON ARANDELA POZI TRILOBULAR

d	3,5	4	5
POZI	1	2	2
C	3,55	4,06	5,06
D	6,6	8	9,6
K	1,6	2	2,3

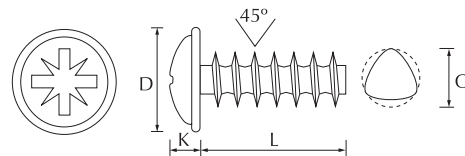

- Tornillo rosca plástico de 45° permite un agarre profundo al material plástico.
- El cuerpo trilobular hace posible que el material desplazado se recupere al enfriar, reduciendo así las tensiones radiales y disminuyendo el riesgo de grietas en el alojamiento.
- Con tratamiento térmico.

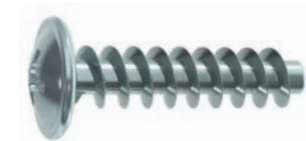

CÓDIGO	(d)	L	+	ENVASE
04080350010Z	3,5	10	PZ1	1000
04080350012Z	3,5	12	PZ1	1000
04080400008Z	4	8	PZ2	1000
04080400016Z	4	16	PZ2	1000
04080400020Z	4	20	PZ2	1000
04080400025Z	4	25	PZ2	1000

CÓDIGO	(d)	L	+	ENVASE
04080500010Z	5	10	PZ2	1000
04080500012Z	5	12	PZ2	1000
04080500016Z	5	16	PZ2	1000
04080500020Z	5	20	PZ2	1000
04080500025Z	5	25	PZ2	500

Consultar cantidad mínima de servicio.

0409 TORNILLO ROSCA PLÁSTICO 45° CABEZA ALOMADA POZI TRILOBULAR

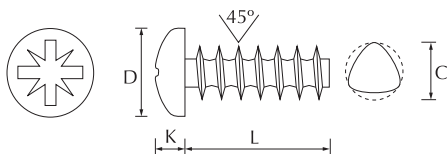

d	1,8	2,2	2,5	3	3,5	4	5	6
POZI	0	1	1	1	1	2	2	2
C	1,85	2,25	2,55	3,05	3,55	4,06	5,06	6,06
D	3,6	4,24	4	5	6	7	8	10
K	1,5	1,57	1,6	1,95	2,3	2,45	2,8	3,5

- Tornillo rosca plástico de 45° permite un agarre profundo al material plástico.
- El cuerpo trilobular hace posible que el material desplazado se recupere al enfriar, reduciendo así las tensiones radiales y disminuyendo el riesgo de grietas en el alojamiento.
- Con tratamiento térmico.

CÓDIGO	(d)	L	+	ENVASE
04090180004Z	1,8	4	PZ1	1000
04090180005Z	1,8	5	PZ1	1000
04090180006Z	1,8	6	PZ1	1000
04090180008Z	1,8	8	PZ1	1000
04090180010Z	1,8	10	PZ1	1000
04090220005Z	2,2	5	PZ1	1000
04090220006Z	2,2	6	PZ1	1000
04090220008Z	2,2	8	PZ1	1000
04090220010Z	2,2	10	PZ1	1000
04090220012Z	2,2	12	PZ1	1000
04090250006Z	2,5	6	PZ1	1000
04090250008Z	2,5	8	PZ1	1000
04090250010Z	2,5	10	PZ1	1000
04090300006Z	3	6	PZ1	1000
04090300008Z	3	8	PZ1	1000
04090300010Z	3	10	PZ1	1000
04090300012Z	3	12	PZ1	1000
04090300016Z	3	16	PZ1	1000
04090300020Z	3	20	PZ1	1000
04090300025Z	3	25	PZ1	1000
04090350006Z	3,5	6	PZ1	1000
04090350008Z	3,5	8	PZ1	1000

CÓDIGO	(d)	L	+	ENVASE
04090350010Z	3,5	10	PZ1	1000
04090350012Z	3,5	12	PZ1	1000
04090350016Z	3,5	16	PZ1	1000
04090350020Z	3,5	20	PZ1	1000
04090350025Z	3,5	25	PZ1	1000
04090400006Z	4	6	PZ2	1000
04090400008Z	4	8	PZ2	1000
04090400010Z	4	10	PZ2	1000
04090400012Z	4	12	PZ2	1000
04090400016Z	4	16	PZ2	1000
04090400020Z	4	20	PZ2	1000
04090400025Z	4	25	PZ2	1000
04090500010Z	5	10	PZ2	1000
04090500012Z	5	12	PZ2	1000
04090500016Z	5	16	PZ2	1000
04090500020Z	5	20	PZ2	1000
04090500025Z	5	25	PZ2	500
04090500030Z	5	30	PZ2	500
04090600016Z	6	16	PZ2	500
04090600020Z	6	20	PZ2	500
04090600025Z	6	25	PZ2	500

Consultar cantidad mínima de servicio.



## 0410 TORNILLO ROSCA PLÁSTICO 45° CABEZA PLANA STAR TRILOBULAR

d	2,5	3	3,5	4	5
STAR	T6	T8	T10	T15	T20
C	2,55	3,05	3,55	4,06	5,06
D	4,4	5,5	6,3	7,35	8,4
K	1,3	1,5	1,65	1,9	2,2

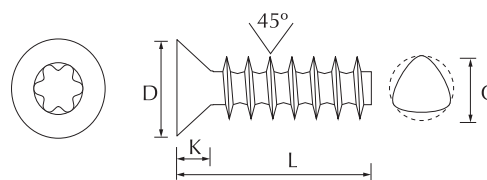

- Tornillo rosca plástico de 45° permite un agarre profundo al material plástico.
- El cuerpo trilobular hace posible que el material desplazado se recupere al enfriar, reduciendo así las tensiones radiales y disminuyendo el riesgo de grietas en el alojamiento.
- Huella hexalobular que mejora el agarre de la punta de atornillar.
- Con tratamiento térmico.



CÓDIGO	(d)	L	★	ENVASE
04100250006Z	2,5	6	T60	1000
04100250008Z	2,5	8	T60	1000
04100250010Z	2,5	10	T60	1000
04100300006Z	3	6	T80	1000
04100300008Z	3	8	T80	1000
04100300010Z	3	10	T80	1000
04100300012Z	3	12	T80	1000
04100350006Z	3,5	6	T10	1000
04100350010Z	3,5	10	T10	1000
04100350012Z	3,5	12	T10	1000
04100350016Z	3,5	16	T10	1000
04100350020Z	3,5	20	T10	1000

CÓDIGO	(d)	L	★	ENVASE
04100400008Z	4	8	T15	1000
04100400010Z	4	10	T15	1000
04100400012Z	4	12	T15	1000
04100400016Z	4	16	T15	1000
04100400020Z	4	20	T15	1000
04100400025Z	4	25	T15	1000
04100500010Z	5	10	T20	1000
04100500012Z	5	12	T20	1000
04100500016Z	5	16	T20	1000
04100500020Z	5	20	T20	1000
04100500025Z	5	25	T20	1000

Consultar cantidad mínima de servicio.

0411 TORNILLO ROSCA PLÁSTICO 45° CABEZA ALOMADA STAR TRILOBULAR

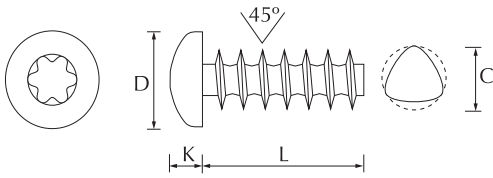

d	2,5	3	3,5	4	5
STAR	T6	T8	T10	T15	T20
C	2,55	3,05	3,55	4,06	5,06
D	4	5	6	7	8
K	1,6	1,95	2,3	2,45	2,8



- Tornillo rosca plástico de 45° permite un agarre profundo al material plástico. El cuerpo trilobular hace posible que el material desplazado se recupere al enfriar, reduciendo así las tensiones radiales y disminuyendo el riesgo de grietas en el alojamiento.
- Huella hexalobular que mejora el agarre de la punta de atornillar.
- Con tratamiento térmico.

CÓDIGO	(d)	L	☼	ENVASE
04110250006Z	2,5	6	T60	1000
04110250008Z	2,5	8	T60	1000
04110300006Z	3	6	T80	1000
04110300008Z	3	8	T80	1000
04110300010Z	3	10	T80	1000
04110300012Z	3	12	T80	1000
04110300016Z	3	16	T80	1000
04110300020Z	3	20	T80	1000
04110350006Z	3,5	6	T10	1000
04110350008Z	3,5	8	T10	1000
04110350010Z	3,5	10	T10	1000
04110350012Z	3,5	12	T10	1000
04110350016Z	3,5	16	T10	1000
04110350025Z	3,5	25	T10	1000

CÓDIGO	(d)	L	☼	ENVASE
04110400006Z	4	6	T15	1000
04110400008Z	4	8	T15	1000
04110400010Z	4	10	T15	1000
04110400012Z	4	12	T15	1000
04110400016Z	4	16	T15	1000
04110400020Z	4	20	T15	1000
04110400025Z	4	25	T15	1000
04110500010Z	5	10	T20	1000
04110500012Z	5	12	T20	1000
04110500016Z	5	16	T20	1000
04110500020Z	5	20	T20	1000
04110500025Z	5	25	T20	500
04110500030Z	5	30	T20	500

Consultar cantidad mínima de servicio.



A photograph of a construction site during the day. In the foreground, a large crane arm extends from the right side towards the center. The background shows the skeletal steel frame of a building under construction, with various beams and columns. The sky is a clear, pale blue. The overall scene is industrial and active.

**TORNILLOS  
ROSCA CHAPA,  
PARA CUBIERTAS  
Y HORMIGÓN**

**05**

0501 DIN 7981 PH

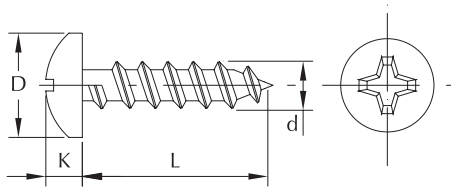

d	2,9	3,3	3,5	3,9	4,2	4,8	5,5	6,3
D	5,6	6,2	6,9	7,5	8,2	9,5	10,8	12,5
K	2,2	2,3	2,6	2,8	3,1	3,5	3,9	4,5



- Tornillo autorroscante de cabeza alomada y huella Phillips.
- Para todo tipo de uniones en materiales metálicos.
- Requiere de taladro previo.
- Con tratamiento térmico.

CÓDIGO	(d)	L	+	ENVASE
05010220006Z	2,2	6,5	PH1	1000
05010290006Z	2,9	6,5	PH1	1000
05010290009Z	2,9	9,5	PH1	1000
05010290013Z	2,9	13	PH1	1000
05010290016Z	2,9	16	PH1	1000
05010290019Z	2,9	19	PH1	1000
05010290022Z	2,9	22	PH1	1000
05010290025Z	2,9	25	PH1	500
05010330006Z	3,3	6,5	PH2	1000
05010330009Z	3,3	9,5	PH2	1000
05010330013Z	3,3	13	PH2	1000
05010330016Z	3,3	16	PH2	1000
05010330019Z	3,3	19	PH2	1000
05010330022Z	3,3	22	PH2	1000
05010330025Z	3,3	25	PH2	1000
05010350006Z	3,5	6,5	PH2	1000
05010350009Z	3,5	9,5	PH2	1000
05010350013Z	3,5	13	PH2	1000
05010350016Z	3,5	16	PH2	500
05010350019Z	3,5	19	PH2	500
05010350022Z	3,5	22	PH2	500
05010350025Z	3,5	25	PH2	500
05010350032Z	3,5	32	PH2	500
05010390006Z	3,9	6,5	PH2	1000
05010390009Z	3,9	9,5	PH2	500
05010390013Z	3,9	13	PH2	500
05010390016Z	3,9	16	PH2	500
05010390019Z	3,9	19	PH2	500
05010390022Z	3,9	22	PH2	500
05010390025Z	3,9	25	PH2	500
05010390032Z	3,9	32	PH2	500
05010390038Z	3,9	38	PH2	500
05010420009Z	4,2	9,5	PH2	500
05010420013Z	4,2	13	PH2	500
05010420016Z	4,2	16	PH2	500
05010420019Z	4,2	19	PH2	500
05010420022Z	4,2	22	PH2	500
05010420025Z	4,2	25	PH2	500
05010420032Z	4,2	32	PH2	500
05010420038Z	4,2	38	PH2	500
05010420045Z	4,2	45	PH2	500
05010420050Z	4,2	50	PH2	500
05010420060Z	4,2	60	PH2	500
05010420070Z	4,2	70	PH2	500
05010480009Z	4,8	9,5	PH2	1000

CÓDIGO	(d)	L	+	ENVASE
05010480013Z	4,8	13	PH2	500
05010480016Z	4,8	16	PH2	500
05010480019Z	4,8	19	PH2	500
05010480022Z	4,8	22	PH2	500
05010480025Z	4,8	25	PH2	500
05010480032Z	4,8	32	PH2	500
05010480038Z	4,8	38	PH2	500
05010480045Z	4,8	45	PH2	500
05010480050Z	4,8	50	PH2	500
05010480060Z	4,8	60	PH2	500
05010480070Z	4,8	70	PH2	200
05010480080Z	4,8	80	PH2	100
05010480090Z	4,8	90	PH2	100
05010480100Z	4,8	100	PH2	100
05010480120Z	4,8	120	PH2	100
05010550013Z	5,5	13	PH3	500
05010550016Z	5,5	16	PH3	500
05010550019Z	5,5	19	PH3	500
05010550022Z	5,5	22	PH3	500
05010550025Z	5,5	25	PH3	500
05010550032Z	5,5	32	PH3	500
05010550038Z	5,5	38	PH3	500
05010550045Z	5,5	45	PH3	500
05010550050Z	5,5	50	PH3	250
05010550060Z	5,5	60	PH3	100
05010550070Z	5,5	70	PH3	100
05010550080Z	5,5	80	PH3	100
05010550090Z	5,5	90	PH3	100
05010550100Z	5,5	100	PH3	100
05010550120Z	5,5	120	PH3	100
05010630013Z	6,3	13	PH3	1000
05010630016Z	6,3	16	PH3	500
05010630019Z	6,3	19	PH3	500
05010630022Z	6,3	22	PH3	500
05010630025Z	6,3	25	PH3	500
05010630032Z	6,3	32	PH3	250
05010630038Z	6,3	38	PH3	250
05010630045Z	6,3	45	PH3	250
05010630050Z	6,3	50	PH3	250
05010630060Z	6,3	60	PH3	100
05010630070Z	6,3	70	PH3	100
05010630080Z	6,3	80	PH3	100
05010630090Z	6,3	90	PH3	100
05010630100Z	6,3	100	PH3	100
05010630120Z	6,3	120	PH3	100

Consultar disponibilidad en otras medidas y/o recubrimientos.

Medidas en mm.

 Puntas de atornillar disponibles en página 272.

0516 DIN 7981 STAR

d	2,2	2,9	3,5	3,9	4,2	4,8	5,5	6,3
D	4,2	5,6	6,9	7,5	8,2	9,5	10,8	12,5
K	1,8	2,2	2,6	2,8	3,05	3,55	3,95	4,55

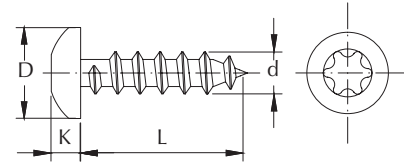

- Tornillo autorroscante de cabeza alomada y huella hexalobular.
- Para todo tipo de uniones en materiales metálicos.
- Requiere de taladro previo.
- Con tratamiento térmico.



CÓDIGO	(d)	L	⊕	ENVASE
05160220006Z	2,2	6,5	T80	1000
05160290006Z	2,9	6,5	T10	1000
05160290008Z	2,9	8	T10	1000
05160290009Z	2,9	9,5	T10	1000
05160290013Z	2,9	13	T10	1000
05160290016Z	2,9	16	T10	1000
05160290019Z	2,9	19	T10	1000
05160290025Z	2,9	25	T10	1000
05160290032Z	2,9	32	T10	1000
05160350006Z	3,5	6,5	T15	1000
05160350008Z	3,5	8	T15	1000
05160350009Z	3,5	9,5	T15	1000
05160350013Z	3,5	13	T15	1000
05160350016Z	3,5	16	T15	1000
05160350019Z	3,5	19	T15	1000
05160350022Z	3,5	22	T15	1000
05160350025Z	3,5	25	T15	1000
05160350032Z	3,5	32	T15	1000
05160350038Z	3,5	38	T15	1000
05160390009Z	3,9	9,5	T15	1000
05160390013Z	3,9	13	T15	1000
05160390016Z	3,9	16	T15	1000
05160390019Z	3,9	19	T15	1000
05160390022Z	3,9	22	T15	1000
05160390025Z	3,9	25	T15	1000
05160390032Z	3,9	32	T15	1000
05160390038Z	3,9	38	T15	500
05160420006Z	4,2	6,5	T20	1000

CÓDIGO	(d)	L	⊕	ENVASE
05160420009Z	4,2	9,5	T20	1000
05160420013Z	4,2	13	T20	1000
05160420016Z	4,2	16	T20	1000
05160420019Z	4,2	19	T20	1000
05160420022Z	4,2	22	T20	1000
05160420025Z	4,2	25	T20	1000
05160420032Z	4,2	32	T20	500
05160420038Z	4,2	38	T20	500
05160420050Z	4,2	50	T20	250
05160480009Z	4,8	9,5	T25	1000
05160480013Z	4,8	13	T25	1000
05160480016Z	4,8	16	T25	1000
05160480019Z	4,8	19	T25	1000
05160480022Z	4,8	22	T25	1000
05160480025Z	4,8	25	T25	1000
05160480032Z	4,8	32	T25	500
05160480038Z	4,8	38	T25	500
05160480045Z	4,8	45	T25	250
05160480050Z	4,8	50	T25	250
05160550013Z	5,5	13	T25	1000
05160550016Z	5,5	16	T25	500
05160550019Z	5,5	19	T25	500
05160550025Z	5,5	25	T25	500
05160630016Z	6,3	16	T30	500
05160630019Z	6,3	19	T30	500
05160630025Z	6,3	25	T30	500
05160630032Z	6,3	32	T30	250
05160630038Z	6,3	38	T30	250

Consultar cantidad mínima de servicio.  
Consultar disponibilidad en otras medidas y/o recubrimientos.

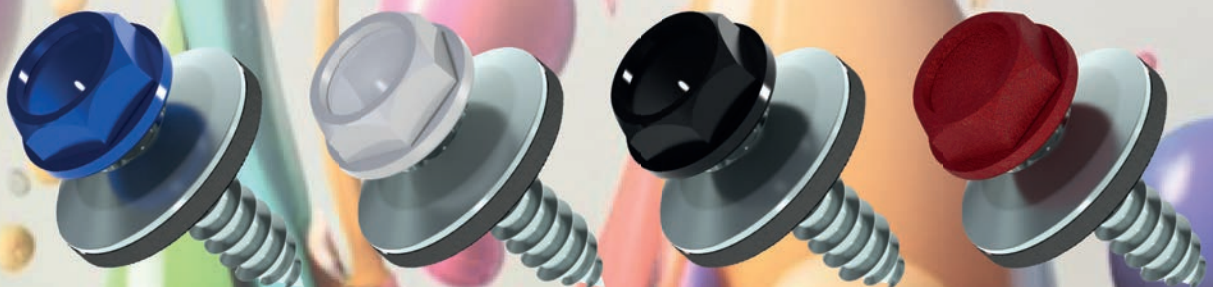

0515 DIN 7981 PZ TIPO F

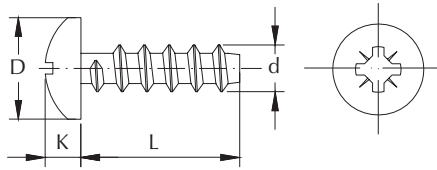

d	2,2	2,9	3,5	3,9	4,2	4,8	5,5	6,3
D	4,2	5,6	6,9	7,5	8,2	9,5	10,8	12,5
K	1,8	2,2	2,6	2,8	3,05	3,55	3,95	4,55

- Tornillo autorroscante sin punta de cabeza alomada y huella Phillips.
- Para todo tipo de uniones en materiales metálicos.
- Requiere de taladro previo.
- Con tratamiento térmico.

CÓDIGO	(d)	L	+	ENVASE
05150220006Z	2,2	6,5	PZ1	1000
05150220008Z	2,2	8	PZ1	1000
05150220009Z	2,2	9,5	PZ1	1000
05150220013Z	2,2	13	PZ1	1000
05150290006Z	2,9	6,5	PZ1	1000
05150290008Z	2,9	8	PZ1	1000
05150290009Z	2,9	9,5	PZ1	1000
05150290013Z	2,9	13	PZ1	1000
05150290016Z	2,9	16	PZ1	1000
05150290019Z	2,9	19	PZ1	1000
05150290025Z	2,9	25	PZ1	1000
05150290032Z	2,9	32	PZ1	1000
05150350009Z	3,5	9,5	PZ2	1000
05150350013Z	3,5	13	PZ2	1000
05150350016Z	3,5	16	PZ2	1000
05150350019Z	3,5	19	PZ2	1000
05150350022Z	3,5	22	PZ2	1000
05150350025Z	3,5	25	PZ2	1000
05150350032Z	3,5	32	PZ2	1000
05150390009Z	3,9	9,5	PZ2	1000
05150390013Z	3,9	13	PZ2	1000

CÓDIGO	(d)	L	+	ENVASE
05150390016Z	3,9	16	PZ2	1000
05150390019Z	3,9	19	PZ2	1000
05150420005Z	4,2	5	PZ2	1000
05150420009Z	4,2	9,5	PZ2	1000
05150420013Z	4,2	13	PZ2	1000
05150420016Z	4,2	16	PZ2	1000
05150420019Z	4,2	19	PZ2	1000
05150420025Z	4,2	25	PZ2	1000
05150420032Z	4,2	32	PZ2	500
05150480009Z	4,8	9,5	PZ2	1000
05150480013Z	4,8	13	PZ2	1000
05150480016Z	4,8	16	PZ2	1000
05150480019Z	4,8	19	PZ2	1000
05150480022Z	4,8	22	PZ2	500
05150480025Z	4,8	25	PZ2	500
05150480032Z	4,8	32	PZ2	500
05150550013Z	5,5	13	PZ3	1000
05150550016Z	5,5	16	PZ3	1000
05150550019Z	5,5	19	PZ3	500
05150550025Z	5,5	25	PZ3	500
05150630013Z	6,3	13	PZ3	500

Consultar cantidad mínima de servicio.  
Consultar disponibilidad en otras medidas y/o recubrimientos.

0502 DIN 7982 PH

d	2,2	2,9	3,5	3,9	4,2	4,8	5,5	6,3
D	4,3	5,6	6,9	7,5	8,2	9,5	10,8	12,4
K	1,3	1,7	2,1	2,3	2,5	3	3,4	3,8

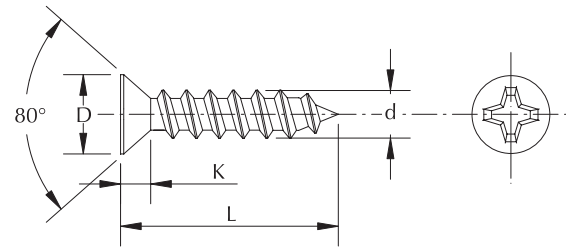

- Tornillo autorroscante de cabeza avellanada y huella Phillips.
- Para todo tipo de uniones en materiales metálicos.
- Requiere de taladro previo.
- Con tratamiento térmico.



CÓDIGO	(d)	L	⊕	ENVASE
05020220006Z	2,2	6,5	PH1	1000
05020220009Z	2,2	9,5	PH1	1000
05020290006Z	2,9	6,5	PH1	1000
05020290009Z	2,9	9,5	PH1	1000
05020290013Z	2,9	13	PH1	1000
05020290016Z	2,9	16	PH1	1000
05020290019Z	2,9	19	PH1	1000
05020290022Z	2,9	22	PH1	1000
05020290025Z	2,9	25	PH1	500
05020290032Z	2,9	32	PH1	500
05020350009Z	3,5	9,5	PH2	1000
05020350013Z	3,5	13	PH2	1000
05020350016Z	3,5	16	PH2	500
05020350019Z	3,5	19	PH2	500
05020350022Z	3,5	22	PH2	500
05020350025Z	3,5	25	PH2	500
05020350032Z	3,5	32	PH2	500
05020350038Z	3,5	38	PH2	500
05020390009Z	3,9	9,5	PH2	500
05020390013Z	3,9	13	PH2	500
05020390016Z	3,9	16	PH2	500
05020390019Z	3,9	19	PH2	500
05020390022Z	3,9	22	PH2	500
05020390025Z	3,9	25	PH2	500
05020390032Z	3,9	32	PH2	500
05020390038Z	3,9	38	PH2	500
05020420009Z	4,2	9,5	PH2	500
05020420013Z	4,2	13	PH2	500
05020420016Z	4,2	16	PH2	500
05020420019Z	4,2	19	PH2	500
05020420022Z	4,2	22	PH2	500
05020420025Z	4,2	25	PH2	500
05020420032Z	4,2	32	PH2	500

CÓDIGO	(d)	L	⊕	ENVASE
05020420038Z	4,2	38	PH2	500
05020420045Z	4,2	45	PH2	500
05020420050Z	4,2	50	PH2	500
05020420060Z	4,2	60	PH2	500
05020480013Z	4,8	13	PH2	500
05020480016Z	4,8	16	PH2	500
05020480019Z	4,8	19	PH2	500
05020480022Z	4,8	22	PH2	500
05020480025Z	4,8	25	PH2	500
05020480032Z	4,8	32	PH2	500
05020480038Z	4,8	38	PH2	500
05020480045Z	4,8	45	PH2	500
05020480050Z	4,8	50	PH2	500
05020480060Z	4,8	60	PH2	500
05020480070Z	4,8	70	PH2	200
05020550013Z	5,5	13	PH3	500
05020550016Z	5,5	16	PH3	500
05020550019Z	5,5	19	PH3	500
05020550022Z	5,5	22	PH3	500
05020550025Z	5,5	25	PH3	500
05020550032Z	5,5	32	PH3	500
05020550038Z	5,5	38	PH3	500
05020550045Z	5,5	45	PH3	500
05020550050Z	5,5	50	PH3	250
05020550060Z	5,5	60	PH3	100
05020550070Z	5,5	70	PH3	100
05020630025Z	6,3	25	PH3	500
05020630032Z	6,3	32	PH3	250
05020630038Z	6,3	38	PH3	250
05020630045Z	6,3	45	PH3	250
05020630050Z	6,3	50	PH3	250
05020630060Z	6,3	60	PH3	100
05020630070Z	6,3	70	PH3	100

Consultar disponibilidad en otras medidas y/o recubrimientos.

0503 DIN 7983 PH

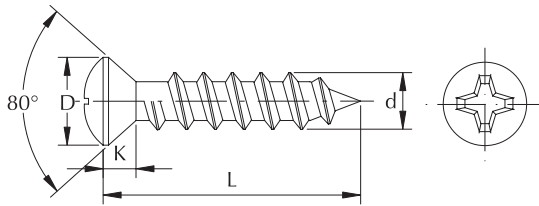

d	2,9	3,5	3,9	4,2	4,8	5,5	6,3
D	5,5	6,9	7,5	8,2	9,5	10,8	12,4
K	1,7	2,1	2,3	2,5	3	3,4	3,8



- Tornillo autorroscante de cabeza gota sebo y huella Phillips.
- Para todo tipo de uniones en materiales metálicos.
- Requiere de taladro previo.
- Con tratamiento térmico.

CÓDIGO	(d)	L	⊕	ENVASE
05030290009Z	2,9	9,5	PH1	1000
05030290013Z	2,9	13	PH1	1000
05030290016Z	2,9	16	PH1	1000
05030290019Z	2,9	19	PH1	1000
05030290022Z	2,9	22	PH1	1000
05030290025Z	2,9	25	PH1	1000
05030350009Z	3,5	9,5	PH2	1000
05030350013Z	3,5	13	PH2	1000
05030350016Z	3,5	16	PH2	1000
05030350019Z	3,5	19	PH2	1000
05030350022Z	3,5	22	PH2	1000
05030350025Z	3,5	25	PH2	1000
05030350032Z	3,5	32	PH2	1000
05030390009Z	3,9	9,5	PH2	1000
05030390013Z	3,9	13	PH2	1000
05030390016Z	3,9	16	PH2	1000
05030390019Z	3,9	19	PH2	1000
05030390022Z	3,9	22	PH2	1000
05030390025Z	3,9	25	PH2	1000
05030390032Z	3,9	32	PH2	1000
05030420009Z	4,2	9,5	PH2	1000
05030420013Z	4,2	13	PH2	1000
05030420016Z	4,2	16	PH2	1000
05030420019Z	4,2	19	PH2	1000
05030420022Z	4,2	22	PH2	1000
05030420025Z	4,2	25	PH2	1000
05030420032Z	4,2	32	PH2	500
05030420038Z	4,2	38	PH2	500
05030420045Z	4,2	45	PH2	500

CÓDIGO	(d)	L	⊕	ENVASE
05030420050Z	4,2	50	PH2	500
05030480013Z	4,8	13	PH2	1000
05030480016Z	4,8	16	PH2	1000
05030480019Z	4,8	19	PH2	1000
05030480022Z	4,8	22	PH2	1000
05030480025Z	4,8	25	PH2	1000
05030480032Z	4,8	32	PH2	1000
05030480038Z	4,8	38	PH2	500
05030480045Z	4,8	45	PH2	500
05030480050Z	4,8	50	PH2	500
05030550013Z	5,5	13	PH3	500
05030550016Z	5,5	16	PH3	500
05030550019Z	5,5	19	PH3	500
05030550022Z	5,5	22	PH3	500
05030550025Z	5,5	25	PH3	500
05030550032Z	5,5	32	PH3	500
05030550038Z	5,5	38	PH3	500
05030550045Z	5,5	45	PH3	500
05030550050Z	5,5	50	PH3	500
05030630013Z	6,3	13	PH3	500
05030630016Z	6,3	16	PH3	500
05030630019Z	6,3	19	PH3	500
05030630022Z	6,3	22	PH3	500
05030630025Z	6,3	25	PH3	250
05030630032Z	6,3	32	PH3	250
05030630038Z	6,3	38	PH3	250
05030630045Z	6,3	45	PH3	250
05030630050Z	6,3	50	PH3	250

Consultar cantidad mínima de servicio.  
Consultar disponibilidad en otras medidas y/o recubrimientos.



**0523 TORN. R/CHAPA HEX. C/ARAN. ESTAMP. (DIN 6928 SIMILAR)**

d	6,3
D	14
K	6
S	10

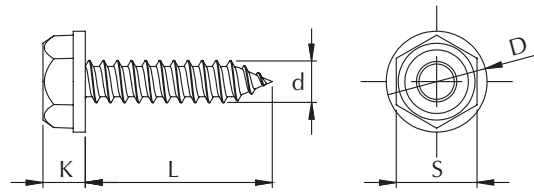

- Tornillo autorroscante de cabeza hexagonal con arandela estampada.
- Para todo tipo de uniones en materiales metálicos.
- Requiere de taladro previo.
- Con tratamiento térmico.



CÓDIGO	(d)	L	ENVASE
05230630019Z	6,3	19	500
05230630025Z	6,3	25	500
05230630032Z	6,3	32	500
05230630040Z	6,3	40	500
05230630050Z	6,3	50	500
05230630060Z	6,3	60	250
05230630080Z	6,3	80	250

CÓDIGO	(d)	L	ENVASE
05230630100Z	6,3	100	250
05230630110Z	6,3	110	250
05230630120Z	6,3	120	250
05230630130Z	6,3	130	250
05230630140Z	6,3	140	100
05230630150Z	6,3	150	100

**0525 TORN. R/CHAPA HEX. C/ARAN. ESTAMP. (DIN 6928 SIMILAR) + EPDM 16**

d	6,3
D	14,5
K	6
S	10
N	16

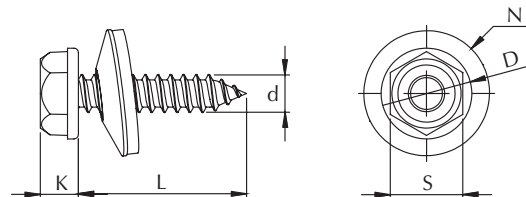

- Tornillo autorroscante de cabeza hexagonal con arandela estampada y arandela EPDM montada.
- Requiere de taladro previo.
- La arandela de neopreno asegura la estanqueidad en instalaciones de cubiertas y fachadas.
- Con tratamiento térmico.



CÓDIGO	(d)	L	ENVASE
05250630019Z	6,3	19	500
05250630025Z	6,3	25	500
05250630032Z	6,3	32	500
05250630040Z	6,3	40	500
05250630050Z	6,3	50	250
05250630060Z	6,3	60	250
05250630080Z	6,3	80	250

CÓDIGO	(d)	L	ENVASE
05250630100Z	6,3	100	250
05250630110Z	6,3	110	250
05250630120Z	6,3	120	100
05250630130Z	6,3	130	100
05250630140Z	6,3	140	100
05250630150Z	6,3	150	100

0508 TORNILLO CABEZA EXTRAPLANA

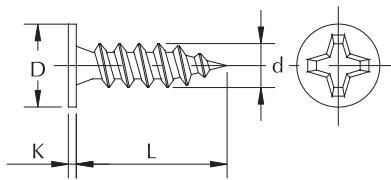

d	4,2
D	7,5
K	1

- Tornillo autorroscante de cabeza extraplana y huella Phillips.
- Para todo tipo de uniones en perfilería metálica.
- Requiere de taladro previo.
- Con tratamiento térmico.



CÓDIGO	(d)	L	+	ENVASE
05080420013Z	4,2	13	PH2	1000
05080420022Z	4,2	22	PH2	500

CÓDIGO	(d)	L	+	ENVASE
05080420032Z	4,2	32	PH2	500



CÓDIGO	(d)	L	+	ENVASE
05080420013N	4,2	13	PH2	1000
05080420022N	4,2	22	PH2	500

CÓDIGO	(d)	L	+	ENVASE
05080420032N	4,2	32	PH2	500



CÓDIGO	(d)	L	+	ENVASE
05080420013W	4,2	13	PH2	1000
05080420022W	4,2	22	PH2	500

CÓDIGO	(d)	L	+	ENVASE
05080420032W	4,2	32	PH2	500

0509 TORNILLO CABEZA EXTRAPLANA AUTOTALADRANTE

d	4,2
D	7,5
K	1

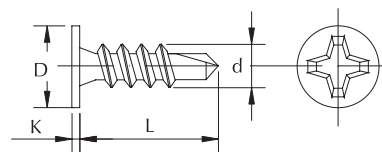

- Tornillo autotaladrante de cabeza extraplana y huella Phillips.
- Para todo tipo de uniones en perfilería metálica.
- Punta broca, no requiere de taladro previo.
- Con tratamiento térmico.



CÓDIGO	(d)	L	+	ENVASE
05090420013Z	4,2	13	PH2	1000
05090420022Z	4,2	22	PH2	500

CÓDIGO	(d)	L	+	ENVASE
05090420032Z	4,2	32	PH2	500



CÓDIGO	(d)	L	+	ENVASE
05090420013N	4,2	13	PH2	1000
05090420022N	4,2	22	PH2	500

CÓDIGO	(d)	L	+	ENVASE
05090420032N	4,2	32	PH2	500



CÓDIGO	(d)	L	+	ENVASE
05090420013W	4,2	13	PH2	1000
05090420022W	4,2	22	PH2	500

CÓDIGO	(d)	L	+	ENVASE
05090420032W	4,2	32	PH2	500

0511 TORNILLO ROSCA CHAPA CON ARANDELA

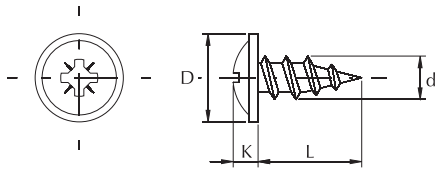

d	2,9	3,5	4,2	4,8
D	7	8,1	9,5	11,3
K	2,1	1,8	3	2,9



- Tornillo autorroscante con arandela estampada y huella Phillips.
- Para todo tipo de uniones en materiales metálicos.
- Requiere de taladro previo.
- Con tratamiento térmico.

CÓDIGO	(d)	L	⊕	ENVASE
05110350009Z	3,5	9,5	PH2	1000
05110350013Z	3,5	13	PH2	1000
05110350016Z	3,5	16	PH2	1000
05110350019Z	3,5	19	PH2	1000
05110350025Z	3,5	25	PH2	1000
05110420009Z	4,2	9,5	PH2	1000
05110420013Z	4,2	13	PH2	1000
05110420016Z	4,2	16	PH2	1000
05110420019Z	4,2	19	PH2	1000

CÓDIGO	(d)	L	⊕	ENVASE
05110420025Z	4,2	25	PH2	1000
05110420032Z	4,2	32	PH2	500
05110480009Z	4,8	9,5	PH2	1000
05110480013Z	4,8	13	PH2	1000
05110480016Z	4,8	16	PH2	1000
05110480019Z	4,8	19	PH2	1000
05110480025Z	4,8	25	PH2	500
05110480032Z	4,8	32	PH2	500
05110480038Z	4,8	38	PH2	500



CÓDIGO	(d)	L	⊕	ENVASE
05110350009N	3,5	9,5	PH2	1000
05110350013N	3,5	13	PH2	1000
05110350016N	3,5	16	PH2	1000
05110350019N	3,5	19	PH2	1000
05110350025N	3,5	25	PH2	1000
05110420009N	4,2	9,5	PH2	1000
05110420013N	4,2	13	PH2	1000
05110420016N	4,2	16	PH2	1000
05110420019N	4,2	19	PH2	1000

CÓDIGO	(d)	L	⊕	ENVASE
05110420025N	4,2	25	PH2	1000
05110420032N	4,2	32	PH2	500
05110480009N	4,8	9,5	PH2	1000
05110480013N	4,8	13	PH2	1000
05110480016N	4,8	16	PH2	1000
05110480019N	4,8	19	PH2	1000
05110480025N	4,8	25	PH2	500
05110480032N	4,8	32	PH2	500
05110480038N	4,8	38	PH2	500



CÓDIGO	(d)	L	⊕	ENVASE
05110290008A	2,9	8	PH1	1000

Consultar cantidad mínima de servicio.

0510 TORNILLO ROSCA CHAPA CON ARANDELA AUTOTALADRANTE

d	4,2
D	11,3
K	2,5

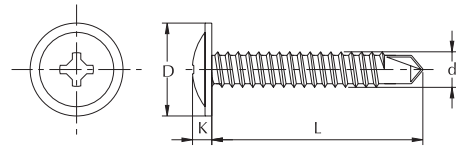

- Tornillo autotaladrante con arandela estampada y huella Phillips.
- Para todo tipo de uniones en materiales metálicos.
- Punta broca, no requiere de taladro previo.
- Con tratamiento térmico.



CÓDIGO	(d)	L	+	ENVASE
05100420009Z	4,2	9,5	PH2	1000
05100420013Z	4,2	13	PH2	1000
05100420016Z	4,2	16	PH2	1000
05100420019Z	4,2	19	PH2	1000
05100420025Z	4,2	25	PH2	1000

CÓDIGO	(d)	L	+	ENVASE
05100420032Z	4,2	32	PH2	500
05100480016Z	4,8	16	PH2	1000
05100480019Z	4,8	19	PH2	1000
05100480025Z	4,8	25	PH2	1000



CÓDIGO	(d)	L	+	ENVASE
05100420013N	4,2	13	PH2	500
05100420016N	4,2	16	PH2	500

CÓDIGO	(d)	L	+	ENVASE
05100420019N	4,2	19	PH2	1000
05100420025N	4,2	25	PH2	500

Consultar cantidad mínima de servicio.  
Consultar disponibilidad en otros recubrimientos.

0512 DIN 7971

d	3,9	4,2	4,8	5,5	6,3
D	7,5	8,2	9,5	10,8	12,5
K	2,2	2,4	2,8	3,2	3,6

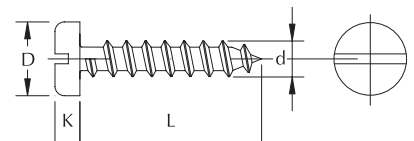

- Tornillo autorroscante de cabeza cilíndrica ranurada.
- Para todo tipo de uniones en materiales metálicos.
- Requiere de taladro previo.
- Con tratamiento térmico.



CÓDIGO	(d)	L	ENVASE
05120420025Z	4,2	25	1000
05120480025Z	4,8	25	1000
05120550025Z	5,5	25	1000

CÓDIGO	(d)	L	ENVASE
05120630016Z	6,3	16	1000

Medidas en mm.  Puntas de atornillar disponibles en página 272.

0504 DIN 7504-N PH

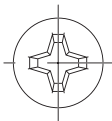
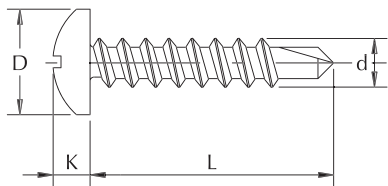

d	3,5	3,9	4,2	4,8	5,5	6,3
D	6,9	7,5	8,2	9,5	10,8	12,5
K	2,6	2,8	3,1	3,5	3,9	4,5



- Tornillo autotaladrante de cabeza alomada y huella Phillips.
- Para todo tipo de uniones en materiales metálicos.
- Punta broca, no requiere de taladro previo.
- Con tratamiento térmico.

CÓDIGO	(d)	L	⊕	ENVASE
05040350009Z	3,5	9,5	PH2	1000
05040350013Z	3,5	13	PH2	1000
05040350016Z	3,5	16	PH2	1000
05040350019Z	3,5	19	PH2	1000
05040350022Z	3,5	22	PH2	1000
05040350025Z	3,5	25	PH2	500
05040350032Z	3,5	32	PH2	500
05040390013Z	3,9	13	PH2	1000
05040390016Z	3,9	16	PH2	1000
05040390019Z	3,9	19	PH2	1000
05040390022Z	3,9	22	PH2	500
05040390025Z	3,9	25	PH2	500
05040390032Z	3,9	32	PH2	500
05040390038Z	3,9	38	PH2	500
05040420013Z	4,2	13	PH2	1000
05040420016Z	4,2	16	PH2	1000
05040420019Z	4,2	19	PH2	1000
05040420022Z	4,2	22	PH2	500
05040420025Z	4,2	25	PH2	500
05040420032Z	4,2	32	PH2	500
05040420038Z	4,2	38	PH2	500
05040420045Z	4,2	45	PH2	500
05040420050Z	4,2	50	PH2	500
05040480013Z	4,8	13	PH2	1000
05040480016Z	4,8	16	PH2	1000
05040480019Z	4,8	19	PH2	1000
05040480022Z	4,8	22	PH2	500
05040480025Z	4,8	25	PH2	500

CÓDIGO	(d)	L	⊕	ENVASE
05040480032Z	4,8	32	PH2	500
05040480038Z	4,8	38	PH2	500
05040480045Z	4,8	45	PH2	500
05040480050Z	4,8	50	PH2	500
05040480060Z	4,8	60	PH2	500
05040480070Z	4,8	70	PH2	250
05040480080Z	4,8	80	PH2	250
05040480090Z	4,8	90	PH2	100
05040480100Z	4,8	100	PH2	100
05040550016Z	5,5	16	PH3	500
05040550019Z	5,5	19	PH3	500
05040550022Z	5,5	22	PH3	500
05040550025Z	5,5	25	PH3	500
05040550032Z	5,5	32	PH3	500
05040550038Z	5,5	38	PH3	500
05040550045Z	5,5	45	PH3	500
05040550050Z	5,5	50	PH3	500
05040550060Z	5,5	60	PH3	250
05040550063Z	5,5	63	PH3	250
05040550070Z	5,5	70	PH3	250
05040550073Z	5,5	73	PH3	250
05040630019Z	6,3	19	PH3	1000
05040630022Z	6,3	22	PH3	1000
05040630025Z	6,3	25	PH3	500
05040630032Z	6,3	32	PH3	500
05040630038Z	6,3	38	PH3	500
05040630045Z	6,3	45	PH3	250
05040630050Z	6,3	50	PH3	500

Consultar disponibilidad en otras medidas y/o recubrimientos.

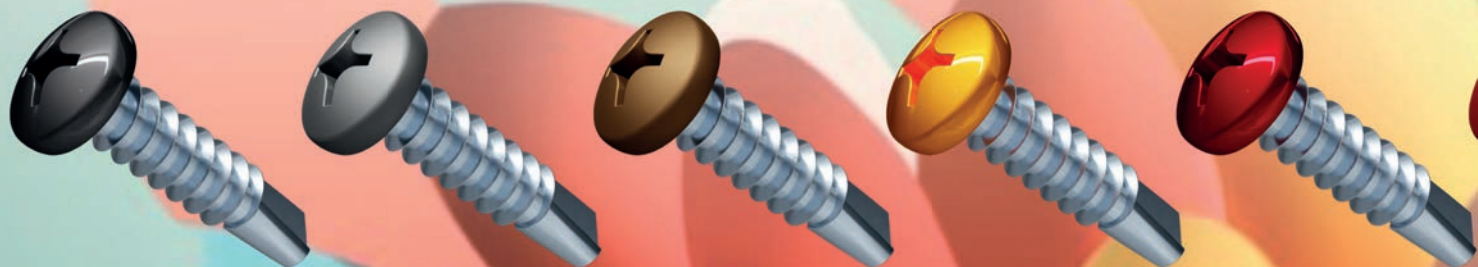

0517 DIN 7504-N STAR

d	3,5	3,9	4,2	4,8	5,5
D	6,9	7,5	8,2	9,5	10,8
K	2,6	2,8	3,1	3,5	3,9

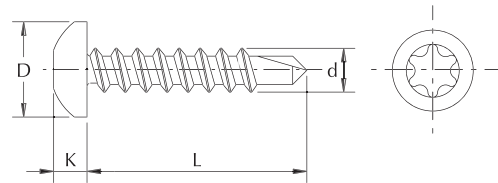

- Tornillo autotaladrante de cabeza alomada y huella hexalobular.
- Para todo tipo de uniones en materiales metálicos.
- Punta broca, no requiere de taladro previo.
- Con tratamiento térmico.

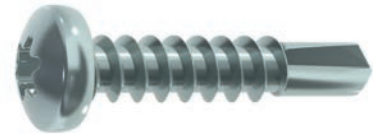

CÓDIGO	(d)	L	⊙	ENVASE
05170350009Z	3,5	9,5	T15	24000
05170350013Z	3,5	13	T15	12000
05170350016Z	3,5	16	T15	12000
05170350019Z	3,5	19	T15	12000
05170350022Z	3,5	22	T15	8000
05170350025Z	3,5	25	T15	8000
05170350032Z	3,5	32	T15	6000
05170390013Z	3,9	13	T15	12000
05170390016Z	3,9	16	T15	12000
05170390019Z	3,9	19	T15	8000
05170390022Z	3,9	22	T15	8000
05170390025Z	3,9	25	T15	6000
05170390032Z	3,9	32	T15	4000
05170420013Z	4,2	13	T20	12000
05170420016Z	4,2	16	T20	8000
05170420019Z	4,2	19	T20	8000
05170420022Z	4,2	22	T20	6000
05170420025Z	4,2	25	T20	6000
05170420032Z	4,2	32	T20	4000
05170420038Z	4,2	38	T20	3000
05170420045Z	4,2	45	T20	3000
05170420050Z	4,2	50	T20	2000
05170480016Z	4,8	16	T25	6000
05170480019Z	4,8	19	T25	6000

CÓDIGO	(d)	L	⊙	ENVASE
05170480022Z	4,8	22	T25	4000
05170480025Z	4,8	25	T25	4000
05170480032Z	4,8	32	T25	3000
05170480038Z	4,8	38	T25	3000
05170480045Z	4,8	45	T25	1600
05170480050Z	4,8	50	T25	500
05170480060Z	4,8	60	T25	1200
05170480080Z	4,8	80	T25	100
05170480090Z	4,8	90	T25	100
05170480100Z	4,8	100	T25	100
05170480110Z	4,8	110	T25	100
05170480120Z	4,8	120	T25	100
05170550016Z	5,5	16	T25	6000
05170550019Z	5,5	19	T25	4000
05170550022Z	5,5	22	T25	4000
05170550025Z	5,5	25	T25	3000
05170550032Z	5,5	32	T25	3000
05170550038Z	5,5	38	T25	2400
05170550045Z	5,5	45	T25	1600
05170550050Z	5,5	50	T25	1200
05170550060Z	5,5	60	T25	800
05170550070Z	5,5	70	T25	800
05170550080Z	5,5	80	T25	800

Consultar cantidad mínima de servicio.  
Consultar disponibilidad en otras medidas y/o recubrimientos.

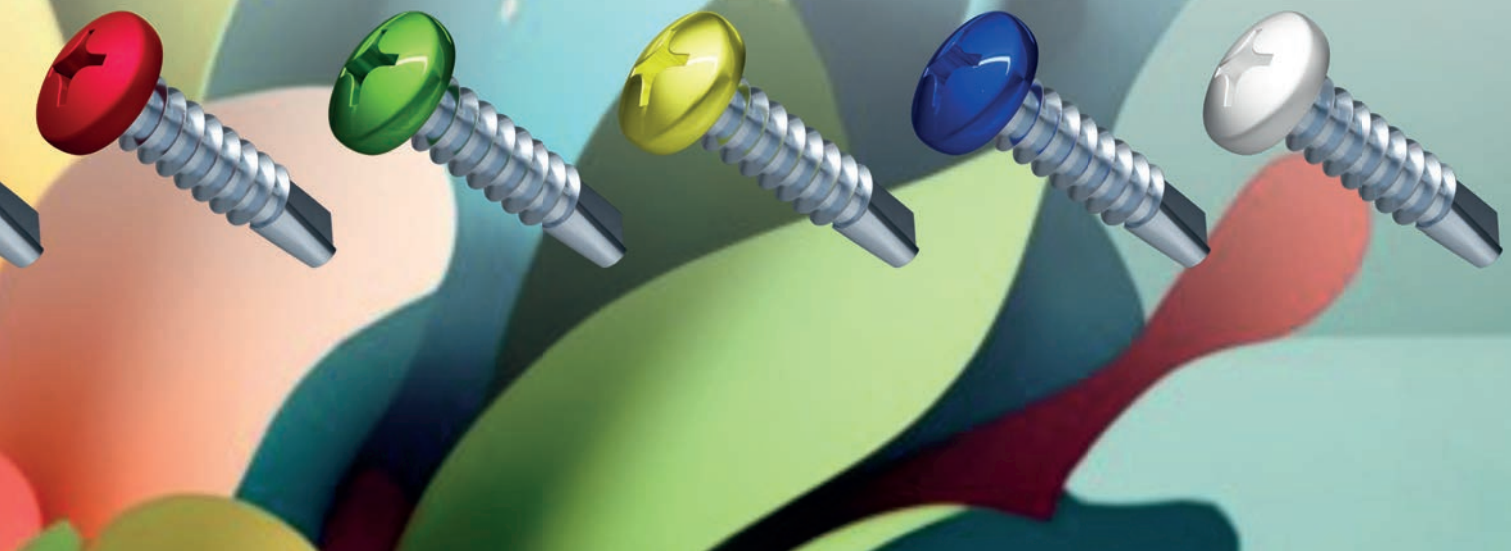

0507 DIN 7504-P PH

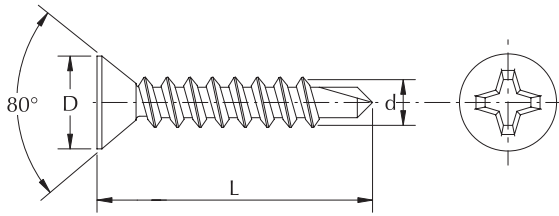

d	3,5	3,9	4,2	4,8	5,5	6,3
D	6,9	7,5	8,2	9,5	10,8	12,5



- Tornillo autotaladrante de cabeza avellanada y huella Phillips.
- Para todo tipo de uniones en materiales metálicos.
- Punta broca, no requiere de taladro previo.
- Con tratamiento térmico.

CÓDIGO	(d)	L	⊕	ENVASE
05070350009Z	3,5	9,5	PH2	1000
05070350013Z	3,5	13	PH2	1000
05070350016Z	3,5	16	PH2	1000
05070350019Z	3,5	19	PH2	1000
05070350022Z	3,5	22	PH2	1000
05070350025Z	3,5	25	PH2	500
05070350032Z	3,5	32	PH2	500
05070390013Z	3,9	13	PH2	1000
05070390016Z	3,9	16	PH2	1000
05070390019Z	3,9	19	PH2	1000
05070390022Z	3,9	22	PH2	500
05070390025Z	3,9	25	PH2	500
05070390032Z	3,9	32	PH2	500
05070390038Z	3,9	38	PH2	500
05070390045Z	3,9	45	PH2	500
05070420013Z	4,2	13	PH2	1000
05070420016Z	4,2	16	PH2	1000
05070420019Z	4,2	19	PH2	1000
05070420022Z	4,2	22	PH2	500
05070420025Z	4,2	25	PH2	500
05070420032Z	4,2	32	PH2	500
05070420038Z	4,2	38	PH2	500
05070420045Z	4,2	45	PH2	500
05070420050Z	4,2	50	PH2	500
05070480016Z	4,8	16	PH2	1000
05070480019Z	4,8	19	PH2	1000

CÓDIGO	(d)	L	⊕	ENVASE
05070480022Z	4,8	22	PH2	500
05070480025Z	4,8	25	PH2	500
05070480032Z	4,8	32	PH2	500
05070480038Z	4,8	38	PH2	500
05070480045Z	4,8	45	PH2	500
05070480050Z	4,8	50	PH2	500
05070480060Z	4,8	60	PH2	500
05070480070Z	4,8	70	PH2	250
05070480080Z	4,8	80	PH2	350
05070550016Z	5,5	16	PH3	1000
05070550019Z	5,5	19	PH3	500
05070550022Z	5,5	22	PH3	500
05070550025Z	5,5	25	PH3	500
05070550032Z	5,5	32	PH3	500
05070550038Z	5,5	38	PH3	500
05070550045Z	5,5	45	PH3	500
05070550050Z	5,5	50	PH3	500
05070550060Z	5,5	60	PH3	250
05070630019Z	6,3	19	PH3	1000
05070630022Z	6,3	22	PH3	1000
05070630025Z	6,3	25	PH3	500
05070630032Z	6,3	32	PH3	500
05070630038Z	6,3	38	PH3	500
05070630045Z	6,3	45	PH3	250
05070630050Z	6,3	50	PH3	250
05070630060Z	6,3	60	PH3	200

Consultar disponibilidad en otras medidas y/o recubrimientos.



**0529 TORNILLO ROSCA CHAPA STAR CON ALETAS AUTOTALADRANTE**

d	4,8	5,5	6,3
D	9,5	10,8	12,4

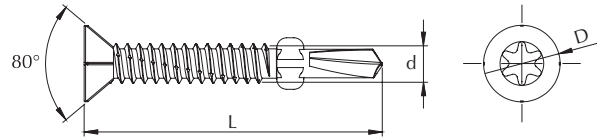

- Tornillo autotaladrante STAR para uniones entre madera y metal.
- Las aletas ayudan a extraer la viruta evitando que el tornillo se sobrecaliente.
- Una vez la punta entra en chapa metálica, las aletas se rompen.
- Punta broca, no requiere de taladro previo.
- Con tratamiento térmico.



CÓDIGO	(d)	L	☉	ENVASE
05290480032Z	4,8	32	T25	500
05290480038Z	4,8	38	T25	500
05290480045Z	4,8	45	T25	500
05290480050Z	4,8	50	T25	500
05290550038Z	5,5	38	T25	500
05290550045Z	5,5	45	T25	500

CÓDIGO	(d)	L	☉	ENVASE
05290550055Z	5,5	55	T25	500
05290550065Z	5,5	65	T25	500
05290630060Z	6,3	60	T30	250
05290630070Z	6,3	70	T30	250
05290630085Z	6,3	85	T30	250

Consultar cantidad mínima de servicio.

**0530 TORNILLO ROSCA CHAPA PH CON ALETAS AUTOTALADRANTE**

d	4,8	5,5	6,3
D	9,5	10,8	12,4

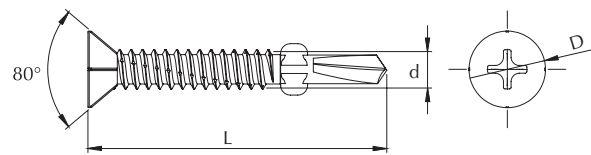

- Tornillo autotaladrante phillips para uniones entre madera y metal.
- Las aletas ayudan a extraer la viruta evitando que el tornillo se sobrecaliente. Una vez la punta entra en chapa metálica, las aletas se rompen.
- Punta broca, no requiere de taladro previo.
- Con tratamiento térmico.



CÓDIGO	(d)	L	☉	ENVASE
05300480032Z	4,8	32	PH2	500
05300480038Z	4,8	38	PH2	500
05300480045Z	4,8	45	PH2	500
05300480050Z	4,8	50	PH2	500
05300550038Z	5,5	38	PH3	500
05300550045Z	5,5	45	PH3	500

CÓDIGO	(d)	L	☉	ENVASE
05300550055Z	5,5	55	PH3	500
05300550065Z	5,5	65	PH3	500
05300630060Z	6,3	60	PH3	250
05300630070Z	6,3	70	PH3	250
05300630085Z	6,3	85	PH3	250

Consultar cantidad mínima de servicio.

0518 DIN 7504-P STAR

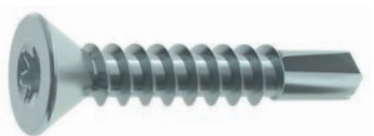
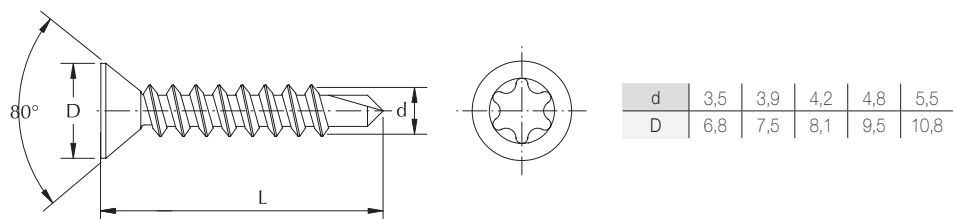

- Tornillo autotaladrante de cabeza avellanada y huella hexalobular.
- Para todo tipo de uniones en materiales metálicos.
- Punta broca, no requiere de taladro previo.
- Huella hexalobular que mejora el agarre de la punta de atornillar.
- Con tratamiento térmico.

CÓDIGO	(d)	L	⊗	ENVASE
05180350013Z	3,5	13	T15	12000
05180350016Z	3,5	16	T15	12000
05180350019Z	3,5	19	T15	12000
05180350022Z	3,5	22	T15	12000
05180350025Z	3,5	25	T15	8000
05180390016Z	3,9	16	T15	12000
05180390019Z	3,9	19	T15	12000
05180390022Z	3,9	22	T15	8000
05180390025Z	3,9	25	T15	8000
05180390032Z	3,9	32	T15	4000
05180420016Z	4,2	16	T20	12000
05180420019Z	4,2	19	T20	8000
05180420022Z	4,2	22	T20	8000
05180420025Z	4,2	25	T20	6000
05180420032Z	4,2	32	T20	4000
05180420038Z	4,2	38	T20	4000

CÓDIGO	(d)	L	⊗	ENVASE
05180480016Z	4,8	16	T25	8000
05180480019Z	4,8	19	T25	6000
05180480022Z	4,8	22	T25	6000
05180480025Z	4,8	25	T25	4000
05180480032Z	4,8	32	T25	4000
05180480038Z	4,8	38	T25	3000
05180480045Z	4,8	45	T25	2400
05180480050Z	4,8	50	T25	1600
05180550025Z	5,5	25	T25	4000
05180550032Z	5,5	32	T25	3000
05180550038Z	5,5	38	T25	2400
05180550045Z	5,5	45	T25	1600
05180550050Z	5,5	50	T25	1200
05180550060Z	5,5	60	T25	1200
05180550070Z	5,5	70	T25	800
05180550080Z	5,5	80	T25	800

Consultar cantidad mínima de servicio.  
Consultar disponibilidad en otras medidas y/o recubrimientos.

0505 DIN 7504-K

d	3,5	4,2	4,8	5,5	6,3
D	8,3	8,8	10,5	11	13,2
K	3,4	4,2	4,4	5,4	6,4
S	5,5	7	8	8	10

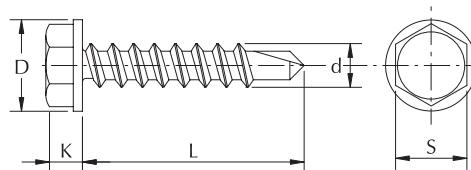

- Tornillo autotaladrante de cabeza hexagonal con arandela estampada.
- Para todo tipo de uniones en materiales metálicos.
- Punta broca, no requiere de taladro previo.
- Con tratamiento térmico.



CÓDIGO	(d)	L	ENVASE
05050350013Z	3,5	13	1000
05050350016Z	3,5	16	1000
05050350019Z	3,5	19	1000
05050350022Z	3,5	22	1000
05050350025Z	3,5	25	1000
05050350032Z	3,5	32	1000
05050420013Z	4,2	13	1000
05050420016Z	4,2	16	1000
05050420019Z	4,2	19	1000
05050420022Z	4,2	22	1000
05050420025Z	4,2	25	500
05050420032Z	4,2	32	500
05050420038Z	4,2	38	500
05050480013Z	4,8	13	1000
05050480016Z	4,8	16	1000
05050480019Z	4,8	19	500
05050480022Z	4,8	22	500
05050480025Z	4,8	25	500
05050480032Z	4,8	32	500
05050480038Z	4,8	38	500
05050480050Z	4,8	50	500

CÓDIGO	(d)	L	ENVASE
05050550019Z	5,5	19	500
05050550022Z	5,5	22	500
05050550025Z	5,5	25	500
05050550032Z	5,5	32	500
05050550038Z	5,5	38	500
05050550050Z	5,5	50	500
05050550063Z	5,5	63	200
05050550075Z	5,5	75	250
05050630019Z	6,3	19	500
05050630022Z	6,3	22	500
05050630025Z	6,3	25	500
05050630032Z	6,3	32	500
05050630038Z	6,3	38	500
05050630050Z	6,3	50	200
05050630063Z	6,3	63	200
05050630075Z	6,3	75	200
05050630080Z	6,3	80	200
05050630090Z	6,3	90	200
05050630100Z	6,3	100	100
05050630110Z	6,3	110	100

Consultar disponibilidad en otras medidas.

0506 DIN 7504-K CON ARANDELA DE NEOPRENO

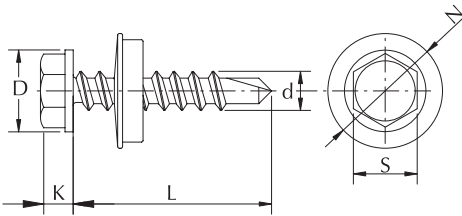

d	4,8	5,5	6,3
D	10,5	11	13,2
K	4,4	5,4	6,4
S	8	8	10
N	16	16	18

- Tornillo autotaladrante de cabeza hexagonal con arandela estampada y arandela EPDM montada.
- Punta broca, no requiere de taladro previo.
- La arandela de neopreno asegura la estanqueidad en instalaciones de cubiertas y fachadas.
- Con tratamiento térmico.

CÓDIGO	(d)	L	ENVASE
05060480016Z	4,8	16	500
05060480019Z	4,8	19	500
05060480022Z	4,8	22	500
05060480025Z	4,8	25	500
05060480032Z	4,8	32	500
05060480038Z	4,8	38	500
05060480050Z	4,8	50	500
05060550019Z	5,5	19	500
05060550022Z	5,5	22	500
05060550025Z	5,5	25	500
05060550032Z	5,5	32	500
05060550038Z	5,5	38	200
05060550050Z	5,5	50	250
05060550063Z	5,5	63	200
05060550075Z	5,5	75	200
05060630019Z	6,3	19	500
05060630022Z	6,3	22	500

CÓDIGO	(d)	L	ENVASE
05060630025Z	6,3	25	500
05060630032Z	6,3	32	500
05060630038Z	6,3	38	500
05060630050Z	6,3	50	200
05060630063Z	6,3	63	200
05060630075Z	6,3	75	100
05060630080Z	6,3	80	100
05060630090Z	6,3	90	100
05060630100Z	6,3	100	100
05060630115Z	6,3	115	100
05060630120Z	6,3	120	100
05060630125Z	6,3	125	100
05060630140Z	6,3	140	100
05060630160Z	6,3	160	100
05060630180Z	6,3	180	100
05060630200Z	6,3	200	100

Consultar disponibilidad en otras medidas y/o recubrimientos.

0531 DIN 7504-K PUNTA REDUCIDA

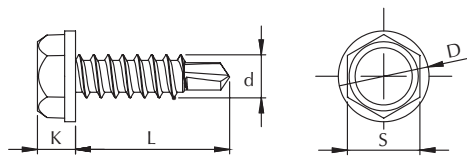

d	4,8	5,5	6,3
D	11	11	13,2
K	4,45	5,45	5,45
S	8	8	8
espesor máximo	0 - 1	1 - 1,5	1 - 1,5

- Tornillo autotaladrante para espesores finos de hasta 1,5mm.
- La broca crea un taladro previo, inferior al diámetro del tornillo que termina de abrirse con la rosca.
- Con tratamiento térmico.

CÓDIGO	(d)	L	ENVASE
05310480016Z	4,8	16	500
05310480019Z	4,8	19	500
05310550022Z	5,5	22	500
05310630020Z	6,3	20	500
05310630025Z	6,3	25	500

CÓDIGO	(d)	L	ENVASE
05310630032Z	6,3	32	500
05310630038Z	6,3	38	500
05310630050Z	6,3	50	250
05310630063Z	6,3	63	250
05310630080Z	6,3	80	250

Medidas en mm.

Útiles para atornillar disponibles en página 276.

0532 DIN 7504-K PUNTA REDUCIDA + EPDM

d	4,8	5,5	6,3
D	11	11	13,2
K	4,45	5,45	5,45
S	8	8	8
N	16	16	16
espesor máximo	0 - 1	1 - 1,5	1 - 1,5

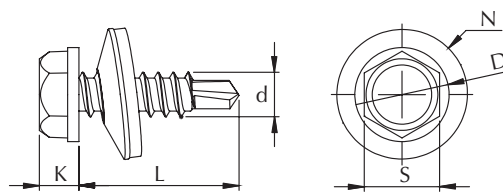

- Tornillo autotaladrante para espesores finos de hasta 1,5mm.
- La broca crea un taladro previo, inferior al diámetro del tornillo que termina de abrirse con la rosca.
- La arandela de neopreno asegura la estanqueidad en instalaciones de cubiertas y fachadas.
- Con tratamiento térmico.



CÓDIGO	(d)	L	ENVASE
05320480016Z	4,8	16	500
05320480019Z	4,8	19	500
05320550022Z	5,5	22	500
05320630020Z	6,3	20	500
05320630025Z	6,3	25	500

CÓDIGO	(d)	L	ENVASE
05320630032Z	6,3	32	500
05320630038Z	6,3	38	500
05320630050Z	6,3	50	250
05320630063Z	6,3	63	250
05320630080Z	6,3	80	250

Consultar cantidad mínima de servicio.

0519 TORNILLO VIGA + EPDM

d	5,5
D	11
K	5,4
S	8
N	16

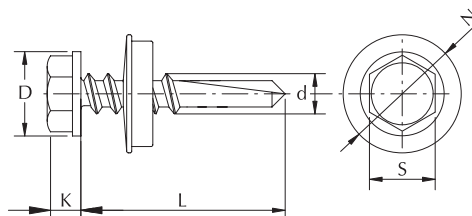

- Tornillo autotaladrante de cabeza hexagonal con arandela estampada y arandela EPDM montada.
- Punta broca nº 5.
- La arandela de neopreno asegura la estanqueidad en instalaciones de cubiertas y fachadas.
- Con tratamiento térmico.



CÓDIGO	(d)	L	ENVASE
05190550032Z	5,5	32	500
05190550038Z	5,5	38	500

CÓDIGO	(d)	L	ENVASE
05190550050Z	5,5	50	250
05190550060Z	5,5	60	250

Consultar cantidad mínima de servicio.  
Consultar disponibilidad en otras medidas.

**0544 TORNILLO BIMETAL + EPDM BROCA Nº 3**

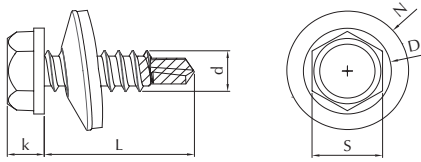

d	4,8	5,5	6,3
D	10,5	11	13,2
K	4,4	5,4	6,4
S	8	8	10
N	16	16	18

- Tornillo autotaladrante de cabeza hexagonal con arandela estampada y arandela EPDM montada.
- Punta broca, no requiere de taladro previo.
- La arandela de neopreno asegura la estanqueidad en instalaciones de cubiertas y fachadas.
- Punta broca de acero con tratamiento térmico; cuerpo inoxidable.

CÓDIGO	(d)	L	ENVASE
05440480025BM	4,8	25	500
05440550025BM	5,5	25	500
05440550032BM	5,5	32	500
05440550050BM	5,5	50	500

CÓDIGO	(d)	L	ENVASE
05440550058BM	5,5	58	250
05440550065BM	5,5	65	250
05440550080BM	5,5	80	250
05440630025BM	6,3	25	500

**0521 DIN 7504-K PANEL SANDWICH + EPDM BROCA Nº 3**

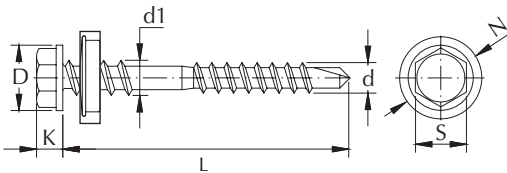

d	5,5
d1	6,3
D	11
K	5,4
S	8
N	16

- Tornillo autotaladrante de cabeza hexagonal con arandela estampada y arandela EPDM montada.
- Punta broca nº 3, no requiere de taladro previo.
- La arandela de neopreno asegura la estanqueidad en instalaciones de paneles aislantes tipo "sándwich" a cubiertas y fachadas.
- Con tratamiento térmico.

CÓDIGO	(d)	L	BROCA	ENVASE
05215563060Z	5,5/6,3	60	3	250
05215563082Z	5,5/6,3	82	3	250

CÓDIGO	(d)	L	BROCA	ENVASE
05215563098Z	5,5/6,3	98	3	250
05215563115Z	5,5/6,3	115	3	250

**0542 DIN 7504-K PANEL SANDWICH + EPDM BROCA Nº 5**

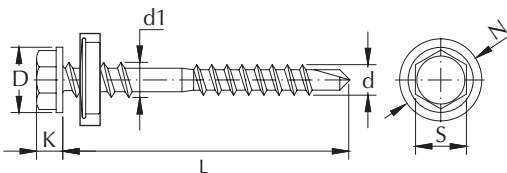

d	5,5
d1	6,3
D	11
K	5,4
S	8
N	16

- Tornillo autotaladrante de cabeza hexagonal con arandela estampada y arandela EPDM montada.
- Punta broca nº 5, no requiere de taladro previo.
- La arandela de neopreno asegura la estanqueidad en instalaciones de paneles aislantes tipo "sándwich" a cubiertas y fachadas.
- Con tratamiento térmico.

CÓDIGO	(d)	L	BROCA	ENVASE
05425563130Z	5,5/6,3	130	5	250

CÓDIGO	(d)	L	BROCA	ENVASE
05425563150Z	5,5/6,3	150	5	250

Medidas en mm.

Útiles para atornillar disponibles en página 276.

**0514 DIN 7504-K PANEL SANDWICH BROCA Nº 3**

d	5,5
d1	6,3
D	11
K	5,4
S	8

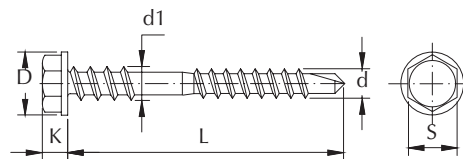

- Tornillo autotaladrante de cabeza hexagonal con arandela estampada.
- Punta broca nº 3, no requiere de taladro previo.
- Instalación de paneles aislantes tipo sándwich a cubiertas y fachadas.
- Con tratamiento térmico.



CÓDIGO	(d)	L	BROCA	ENVASE
05145563082Z	5,5/6,3	82	3	250
05145563098Z	5,5/6,3	98	3	250

CÓDIGO	(d)	L	BROCA	ENVASE
05145563115Z	5,5/6,3	115	3	250

**0543 DIN 7504-K PANEL SANDWICH BROCA Nº 5**

d	5,5
d1	6,3
D	11
K	5,4
S	8

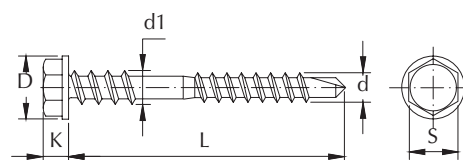

- Tornillo autotaladrante de cabeza hexagonal con arandela estampada.
- Punta broca nº 5, no requiere de taladro previo.
- Instalación de paneles aislantes tipo sándwich a cubiertas y fachadas.
- Con tratamiento térmico.



CÓDIGO	(d)	L	BROCA	ENVASE
05435563130Z	5,5/6,3	130	5	250

CÓDIGO	(d)	L	BROCA	ENVASE
05435563150Z	5,5/6,3	150	5	250

# NUEVA GAMA

## TORNILLERÍA PARA HORMIGÓN



### 0110 TORNILLO PARED STAR

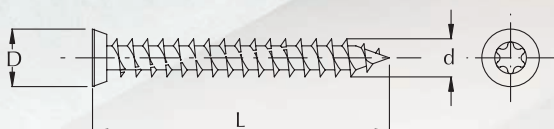

d mm	7,5
D mm	11



- Tornillo para hormigón con huella hexalobular y estrías en la rosca.
- Con tratamiento térmico que aporta mayor dureza.

CÓDIGO	(d)	L	○	ENVASE
01100750042B	7,5	42	T30	200
01100750062B	7,5	62	T30	150
01100750072B	7,5	72	T30	150

CÓDIGO	(d)	L	○	ENVASE
01100750092B	7,5	92	T30	100
01100750112B	7,5	112	T30	100
01100750132B	7,5	132	T30	100



CÓDIGO	(d)	L	○	ENVASE
01100750042Z	7,5	42	T30	200
01100750062Z	7,5	62	T30	150
01100750072Z	7,5	72	T30	150

CÓDIGO	(d)	L	○	ENVASE
01100750092Z	7,5	92	T30	100
01100750112Z	7,5	112	T30	100
01100750132Z	7,5	132	T30	100



**0540 TORNILLO FIJACIÓN DIRECTA A HORMIGÓN HEXAGONAL**

d	6	8	10	12	14	16
S	10	13	15	16	18	21

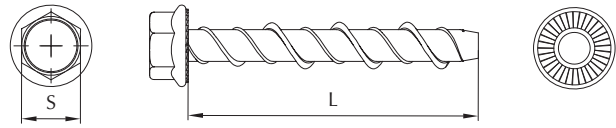

- Tornillo para fijación directa en hormigón fisurado y no fisurado.
- Permite fijar elementos estructurales y no estructurales (escaleras metálicas, barandillas, estanterías, etc.)
- Cabeza hexagonal.
- Recubrimiento anticorrosivo.



CÓDIGO	(d)	L	ENVASE
05400600030A	6	30	100
05400600050A	6	50	100
05400600075A	6	75	100
05400600100A	6	100	100
05400800060A	8	60	50
05400800075A	8	75	50
05400800100A	8	100	50
05401000060A	10	60	50
05401000075A	10	75	50
05401000100A	10	100	50
05401000130A	10	130	25
05401000150A	10	150	25

CÓDIGO	(d)	L	ENVASE
05401000200A	10	200	20
05401000240A	10	240	20
05401200075A	12	75	25
05401200100A	12	100	25
05401200150A	12	150	20
05401400080A	14	80	20
05401400100A	14	100	20
05401400130A	14	130	20
05401400150A	14	150	10
05401600100A	16	100	20
05401600150A	16	150	10

Útiles para atornillar disponibles en página 276.

**0541 TORNILLO FIJACIÓN DIRECTA A HORMIGÓN AVELLANADO**

d	6	8	10
D	16	20	24

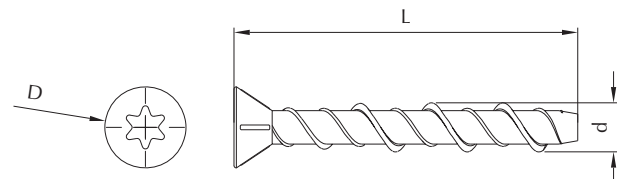

- Tornillo para fijación directa en hormigón fisurado y no fisurado.
- Permite fijar elementos estructurales y no estructurales (escaleras metálicas, barandillas, estanterías, etc.)Cabeza avellanada.
- Recubrimiento anticorrosivo.



CÓDIGO	(d)	L	○	ENVASE
05410600070A	6	70	T30	200
05410600100A	6	100	T30	200
05410600140A	6	140	T30	80
05410800080A	8	80	T45	200
05410800100A	8	100	T45	200

CÓDIGO	(d)	L	○	ENVASE
05410800160A	8	160	T45	80
05411000100A	10	100	T50	100
05411000120A	10	120	T50	80
05411000180A	10	180	T50	80

**0533 TORNILLO PARA HORMIGÓN C/HEX. HI-LO, PUNTA DIAMANTE**

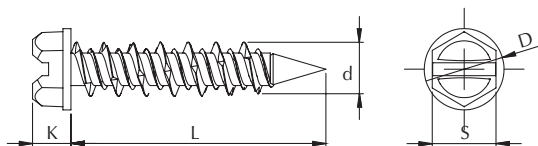

d	6,5
D	10,5
K	5
S	8



- Rosca especial Hi-Lo® 60°/40° para atornillar marcos de puertas y ventanas, paneles sándwich a hormigón, madera, ladrillo hueco y macizo.
- Recubrimiento ruspert de alta resistencia a corrosión.
- Requiere taladro previo.
- Con tratamiento térmico.

CÓDIGO	(d)	L	ENVASE
05330650032J	6,5	32	1000
05330650045J	6,5	45	500
05330650057J	6,5	57	500
05330650070J	6,5	70	500
05330650080J	6,5	80	250

CÓDIGO	(d)	L	ENVASE
05330650100J	6,5	100	250
05330650115J	6,5	115	250
05330650125J	6,5	125	250
05330650150J	6,5	150	250

**0534 TORNILLO PARA HORMIGÓN C/HEX. HI-LO, PUNTA DIAMANTE + EPDM 16**

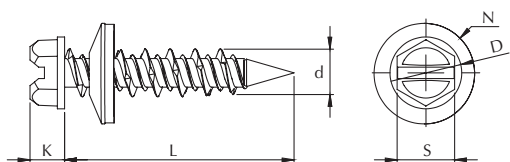

d	6,5
D	10,5
K	5
S	8
N	16



- Rosca especial Hi-Lo® 60°/40° para atornillar marcos de puertas y ventanas, paneles sándwich a hormigón, madera, ladrillo hueco y macizo.
- Recubrimiento ruspert de alta resistencia a corrosión.
- Requiere taladro previo.
- La arandela de neopreno asegura la estanqueidad en instalaciones de cubiertas y fachadas.
- Con tratamiento térmico.

CÓDIGO	(d)	L	ENVASE
05340650032J	6,5	32	1000
05340650045J	6,5	45	500
05340650057J	6,5	57	500
05340650070J	6,5	70	500
05340650080J	6,5	80	250

CÓDIGO	(d)	L	ENVASE
05340650100J	6,5	100	250
05340650115J	6,5	115	250
05340650125J	6,5	125	250
05340650150J	6,5	150	250



**TORNILLOS PVC**

**20**

### 2001 TORNILLO PVC CABEZA PLANA

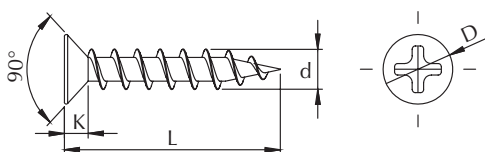

d	4,3
D	7,5
K	2,6

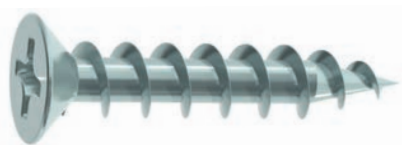

- Tornillo de cabeza plana para fijar herrajes metálicos a periferia de PVC.
- Requiere de taladro previo en piezas metálicas, pero no en plástico PVC, perforándolo directamente.
- Dureza superficie: >500 HV
- Dureza núcleo: 240-450 HV

CÓDIGO	(d)	L	+	ENVASE
20010430016Z	4,3	16	PH2	1000
20010430019Z	4,3	19	PH2	1000
20010430022Z	4,3	22	PH2	1000
20010430025Z	4,3	25	PH2	1000

CÓDIGO	(d)	L	+	ENVASE
20010430030Z	4,3	30	PH2	1000
20010430038Z	4,3	38	PH2	500
20010430045Z	4,3	45	PH2	500
20010430055Z	4,3	55	PH2	500

### 2002 TORNILLO PVC CABEZA PLANA ROSCA HI-LO

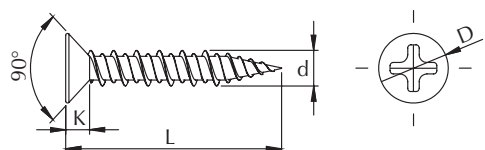

d	3,9
D	7,5
K	2,6



- Tornillo de cabeza plana para fijar herrajes metálicos a periferia de PVC.
- Requiere de taladro previo en piezas metálicas, pero no en plástico PVC, perforándolo directamente.
- Rosca especial Hi-Lo® para una cómoda inserción en materiales de alta densidad.
- Dureza superficie: >500 HV
- Dureza núcleo: 240-450 HV

CÓDIGO	(d)	L	+	ENVASE
20020390025Z	3,9	25	PH2	1000
20020390030Z	3,9	30	PH2	1000

CÓDIGO	(d)	L	+	ENVASE
20020390038Z	3,9	38	PH2	500
20020390045Z	3,9	45	PH2	500

## 2003 TORNILLO PVC CABEZA PLANA AUTOTALADRANTE

d	3,9
D	7,5
K	3

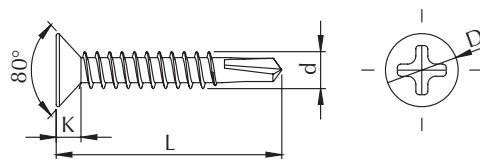

- Tornillo de cabeza plana para fijar herrajes metálicos de  $\leq 2,5\text{mm}$  de espesor a perfilera de PVC.
- Espesor total a fijar  $\leq 9\text{mm}$ .
- Punta autotaladrante, no requiere de taladro previo.
- Rosca plástico 60° – autorroscante en PVC.
- Dureza superficie:  $>500\text{ HV}$
- Dureza núcleo: 240-450 HV

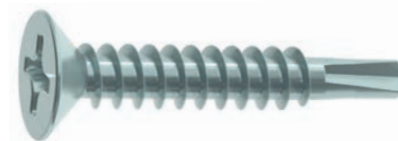

CÓDIGO	(d)	L	+	ENVASE
20030390013Z	3,9	13	PH2	1000
20030390016Z	3,9	16	PH2	1000
20030390019Z	3,9	19	PH2	1000
20030390022Z	3,9	22	PH2	1000

CÓDIGO	(d)	L	+	ENVASE
20030390025Z	3,9	25	PH2	1000
20030390032Z	3,9	32	PH2	1000
20030390038Z	3,9	38	PH2	500

## 2004 TORNILLO PVC CABEZA PLANA ROSCA MÉTRICA AUTOTALADRANTE

d	M4
D	7,5
K	2,3

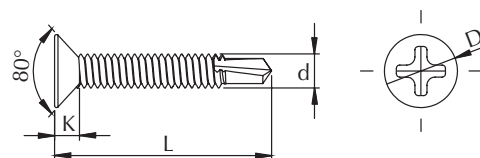

- Tornillo de cabeza plana para fijar herrajes metálicos de  $\leq 2,5\text{mm}$  de espesor a perfilera de PVC.
- Espesor total a fijar  $>9\text{mm}$ .
- Punta autotaladrante, no requiere de taladro previo.
- Rosca métrica – autorroscante en PVC.
- Dureza superficie:  $>500\text{ HV}$
- Dureza núcleo: 240-450 HV

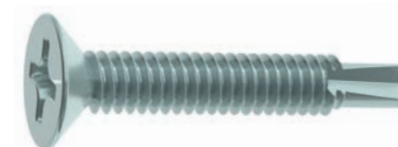

CÓDIGO	(d)	L	+	ENVASE
20040400013Z	M4	13	PH2	1000
20040400016Z	M4	16	PH2	1000
20040400019Z	M4	19	PH2	1000

CÓDIGO	(d)	L	+	ENVASE
20040400025Z	M4	25	PH2	1000
20040400032Z	M4	32	PH2	1000

# ENERGÍA LIMPIA, RENOVABLE Y SOSTENIBLE



## NUESTRO COMPROMISO CON EL MEDIO AMBIENTE

En Matriu S.L creemos en la necesidad de reducir nuestra huella de carbono y adoptar fuentes de energía renovable para contribuir al cuidado del medio ambiente. Por ello hemos apostado por la instalación de 128 paneles fotovoltaicos para autoconsumo energético de nuestras instalaciones.

Además, realizamos el seguimiento de las directivas y reglamentos medioambientales como:

- RoHS bajo EN 71-3:2013 + A3:2018 tanto en material base como los recubrimientos de zinc blanco.
- REACH: análisis de Cadmio (Cd) y Plomo (Pb) en componentes plásticos.

A person wearing a white lab coat and a blue tie is shown from the chest up, holding a small, light-colored object in their right hand. The background is a blurred laboratory or workshop environment with various pieces of equipment and materials. The overall image has a blue-tinted overlay.

**TORNILLOS  
DE PLÁSTICO**

**06**

0601 DIN 84 NYLON

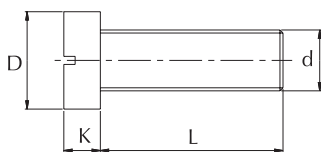

d	M3	M4	M5	M6	M8	M10
D	5,5	7	8,5	10	13	16
K	2	2,6	3,3	3,9	5	6

- Tornillo cilíndrico ranurado en poliamida 6.6 en color blanco natural.
- Aplicaciones en casos cuando el peso es un factor determinante, se precisa aislamiento eléctrico o para evitar corrosión.

CÓDIGO	(d)	L	ENVASE
060103000061	M3	6	200
060103000081	M3	8	200
060103000101	M3	10	200
060103000121	M3	12	200
060103000161	M3	16	200
060103000201	M3	20	200
060103000251	M3	25	200
060103000301	M3	30	200
060104000061	M4	6	200
060104000081	M4	8	200
060104000101	M4	10	200
060104000121	M4	12	200
060104000161	M4	16	200
060104000201	M4	20	200
060104000251	M4	25	200
060104000301	M4	30	200
060104000351	M4	35	200
060104000401	M4	40	200
060105000061	M5	6	200
060105000081	M5	8	200
060105000101	M5	10	200
060105000121	M5	12	200
060105000141	M5	14	200
060105000161	M5	16	200
060105000201	M5	20	200
060105000251	M5	25	200
060105000301	M5	30	200
060105000351	M5	35	200
060105000401	M5	40	200

CÓDIGO	(d)	L	ENVASE
060105000451	M5	45	200
060105000501	M5	50	200
060106000051	M6	5	200
060106000081	M6	8	200
060106000101	M6	10	200
060106000121	M6	12	200
060106000161	M6	16	200
060106000201	M6	20	200
060106000251	M6	25	200
060106000301	M6	30	200
060106000351	M6	35	200
060106000401	M6	40	200
060106000451	M6	45	200
060106000501	M6	50	200
060106000601	M6	60	100
060106000701	M6	70	100
060108000101	M8	10	200
060108000161	M8	16	200
060108000201	M8	20	200
060108000251	M8	25	200
060108000301	M8	30	200
060108000351	M8	35	200
060108000401	M8	40	100
060108000501	M8	50	100
060108000601	M8	60	100
060108000801	M8	80	100
060110000201	M10	20	100
060110000301	M10	30	100

Consultar cantidad mínima de servicio.

0602 DIN 912 NYLON

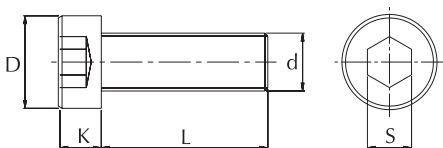

d	M8	M10	M12
D	13	16	18
K	8	10	12
S	6	8	10

- Tornillo allen en poliamida 6.6 en color blanco natural.
- Aplicaciones en casos de cuando el peso es un factor determinante, se precisa aislamiento eléctrico o para evitar corrosión.

CÓDIGO	(d)	L	ENVASE
060208000161	M8	16	1000
060208000301	M8	30	1000
060210000161	M10	16	500

CÓDIGO	(d)	L	ENVASE
060210000301	M10	30	500
060212000501	M12	50	250
060212000601	M12	60	250

Consultar cantidad mínima de servicio.

Medidas en mm.



0603 DIN 933-931 NYLON

d	M3	M4	M5	M6	M8
K	2	2,8	3,5	4	5,3
S	5,5	7	8	10	13

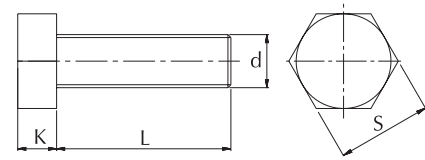

- Tornillo hexagonal en poliamida 6.6 en color blanco natural.
- Aplicaciones en casos de cuando el peso es un factor determinante, se precisa aislamiento eléctrico o para evitar corrosión.

CÓDIGO	(d)	L	ENVASE
060303000061	M3	6	200
060303000081	M3	8	200
060303000101	M3	10	200
060303000121	M3	12	200
060303000161	M3	16	200
060303000201	M3	20	200
060303000251	M3	25	200
060303000301	M3	30	200
060304000061	M4	6	200
060304000081	M4	8	200
060304000101	M4	10	200
060304000121	M4	12	200
060304000161	M4	16	200
060304000201	M4	20	200
060304000251	M4	25	200
060304000301	M4	30	200
060304000351	M4	35	200
060304000401	M4	40	200
060305000061	M5	6	200
060305000081	M5	8	200
060305000101	M5	10	200
060305000121	M5	12	200
060305000161	M5	16	200
060305000201	M5	20	200
060305000251	M5	25	200
060305000301	M5	30	200
060305000351	M5	35	200

CÓDIGO	(d)	L	ENVASE
060305000401	M5	40	200
060305000451	M5	45	200
060305000501	M5	50	200
060306000061	M6	6,5	200
060306000081	M6	8	200
060306000101	M6	10	200
060306000121	M6	12	200
060306000161	M6	16	200
060306000201	M6	20	200
060306000251	M6	25	200
060306000301	M6	30	200
060306000351	M6	35	200
060306000401	M6	40	200
060306000451	M6	45	200
060306000501	M6	50	200
060306000601	M6	60	200
060306000701	M6	70	200
060308000101	M8	10	200
060308000161	M8	16	200
060308000201	M8	20	200
060308000251	M8	25	200
060308000301	M8	30	200
060308000351	M8	35	200
060308000401	M8	40	200
060308000501	M8	50	200
060308000601	M8	60	200
060308000801	M8	80	200

Consultar cantidad mínima de servicio.

0604 TORNILLO CABEZA REDONDA NYLON

d	M3	M4	M5	M6
D	5,5	7	9	10
K	2,7	3,5	4,5	5

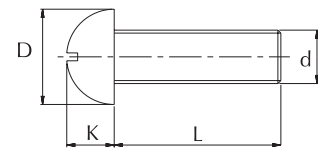

- Tornillo cabeza redonda en poliamida 6.6 en color blanco natural.
- Aplicaciones en casos de cuando el peso es un factor determinante, se precisa aislamiento eléctrico o para evitar corrosión.

CÓDIGO	(d)	L	ENVASE
060403000061	M3	6	1000
060403000101	M3	10	1000
060403000161	M3	16	1000
060403000201	M3	20	1000
060404000101	M4	10	1000
060404000161	M4	16	1000
060404000201	M4	20	1000

CÓDIGO	(d)	L	ENVASE
060405000101	M5	10	1000
060405000161	M5	16	1000
060405000201	M5	20	1000
060406000161	M6	16	1000
060406000201	M6	20	1000
060406000251	M6	25	1000
060406000301	M6	30	1000

Consultar cantidad mínima de servicio.

Medidas en mm.

0605 TORNILLO CABEZA ALOMADA CRUZ NYLON

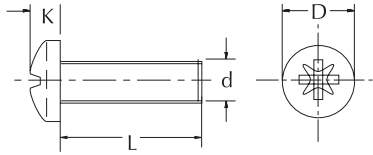

d	M3	M4	M5	M6	M8	M10
D	5,6	8	9,5	12	16	20
K	2,4	3,1	3,7	4	6	7,5



- Tornillo cabeza alomada en poliamida 6.6 en color blanco natural.
- Aplicaciones en casos de cuando el peso es un factor determinante, se precisa aislamiento eléctrico o para evitar corrosión.

CÓDIGO	(d)	L	ENVASE
060503000061	M3	6	200
060503000081	M3	8	200
060503000101	M3	10	200
060503000121	M3	12	200
060503000161	M3	16	200
060503000201	M3	20	200
060503000251	M3	25	200
060503000301	M3	30	200
060504000061	M4	6	200
060504000081	M4	8	200
060504000101	M4	10	200
060504000121	M4	12	200
060504000161	M4	16	200
060504000201	M4	20	200
060504000251	M4	25	200
060504000301	M4	30	200
060504000351	M4	35	200
060504000401	M4	40	200
060505000061	M5	6	200
060505000081	M5	8	200
060505000101	M5	10	200
060505000121	M5	12	200
060505000161	M5	16	200
060505000201	M5	20	200
060505000251	M5	25	200
060505000301	M5	30	200

CÓDIGO	(d)	L	ENVASE
060505000351	M5	35	200
060505000401	M5	40	200
060505000451	M5	45	200
060505000501	M5	50	200
060506000051	M6	5	200
060506000081	M6	8	200
060506000101	M6	10	200
060506000121	M6	12	200
060506000161	M6	16	200
060506000201	M6	20	200
060506000251	M6	25	200
060506000301	M6	30	200
060506000351	M6	35	200
060506000401	M6	40	200
060506000451	M6	45	200
060506000501	M6	50	200
060506000601	M6	60	200
060508000201	M8	20	200
060508000221	M8	22	1000
060508000251	M8	25	1000
060508000301	M8	30	1000
060508000401	M8	40	1000
060508000501	M8	50	1000
060510000201	M10	20	1000
060510000301	M10	30	1000
060510000401	M10	40	1000

Consultar cantidad mínima de servicio.

Medidas en mm.

0606 DIN 555 NYLON

d	M3	M4	M5	M6	M8	M10	M12
m	2,4	3,2	4,2	5	6,5	8	10,8
S	5,5	7	8	10	13	17	19
e1	6,1	8	9	11,2	15	19,2	21,2

d	M14	M16	M20	M24
m	12,8	14,8	18	21,5
S	21,5	23,5	30	36
e1	24,5	27	33	41

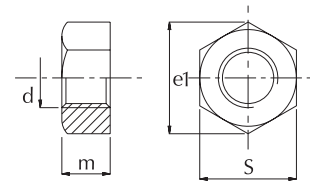

- Tuerca hexagonal en poliamida 6.6 en color blanco natural.
- Aplicaciones en casos de cuando el peso es un factor determinante, se precisa aislamiento eléctrico o para evitar corrosión.

CÓDIGO	(d)	ENVASE
060603000001	M3	200
060604000001	M4	200
060605000001	M5	200
060606000001	M6	200
060608000001	M8	200
060610000001	M10	200

CÓDIGO	(d)	ENVASE
060612000001	M12	100
060614000001	M14	500
060616000001	M16	50
060620000001	M20	250
060624000001	M24	250

Consultar cantidad mínima de servicio.

0607 DIN 125 NYLON

Medida	M3	M3,5	M4	M5	M6	M8	M10
d	3,2	3,7	4,3	5,3	6,4	8,4	10,5
D	7	8	9	10	12	16	20
e	0,5	0,5	0,8	1	1,6	1,6	2

Medida	M12	M14	M16	M20
d	13	15	17	21
D	24	30	30	37
e	2,5	3	3	3

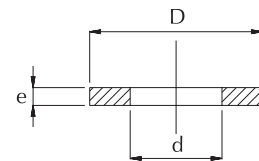

- Arandela plana en poliamida 6.6 en color blanco natural.
- Aplicaciones en casos de cuando el peso es un factor determinante, se precisa aislamiento eléctrico o para evitar corrosión.

CÓDIGO	(d)	ENVASE
060703000001	M3	1000
060703500001	M3,5	1000
060704000001	M4	1000
060705000001	M5	1000
060706000001	M6	1000
060708000001	M8	1000

CÓDIGO	(d)	ENVASE
060710000001	M10	1000
060712000001	M12	500
060714000001	M14	1000
060716000001	M16	250
060720000001	M20	250

Consultar cantidad mínima de servicio.

0608 DIN 9021 NYLON

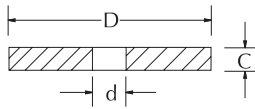

Medida	M3	M4	M5	M6	M8	M10	M12
d	3,2	4,3	5,3	6,4	8,4	10,5	13
D	9	12	15	18	24	30	37
e	0,8	1	1,2	1,6	2	2,5	3

Medida	M16	M20	M24
d	17	22	26
D	50	60	72
e	3	4	5

- Arandela plana de ala ancha en poliamida 6.6 en color blanco natural.
- Aplicaciones en casos cuando el peso es un factor determinante, se precisa aislamiento eléctrico o para evitar corrosión.

CÓDIGO	( d )	ENVASE
060803000001	M3	1000
060804000001	M4	1000
060805000001	M5	1000
060806000001	M6	1000
060808000001	M8	1000

CÓDIGO	( d )	ENVASE
060810000001	M10	1000
060812000001	M12	500
060816000001	M16	250
060820000001	M20	250
060824000001	M24	250

Consultar cantidad mínima de servicio.

Medidas en mm.



TUERCAS

07

0709 DIN 934

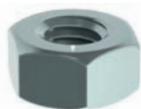
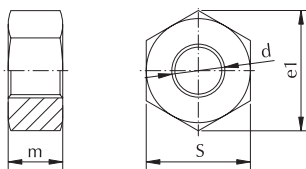

d	M2	M3	M4	M5	M6	M7	M8	M10	M12	M14	M16	M18
m	2	2,4	3,2	4	5	5,5	6,5	8	10	11	13	15
S	4	5,5	7	8	10	11	13	17	19	22	24	27
e1	4,3	6,1	7,7	8,7	10,9	12	14,3	18,8	20,9	24,2	26,4	29,8

d	M20	M22	M24	M27	M30	M33	M36	M39	M42	1/8"	3/16"	1/4"
m	16	18	19	22	24	26	29	31	34	2,2	4	5,5
S	30	32	36	41	46	50	55	60	65	5,5	8	11
e1	33,2	35,4	39,8	45,2	51,1	55,4	60,7	66,4	71,3	6	9	12,5

- Tuerca hexagonal para todo tipo de montajes con varillas roscadas y tornillos métricos.

CÓDIGO	(d)	ENVASE
07090200000Z	M2	1000
07090300000Z	M3	1000
07090400000Z	M4	1000
07090500000Z	M5	1000
07090600000Z	M6	1000
07090700000Z	M7	1000
07090800000Z	M8	1000
07091000000Z	M10	500
07091200000Z	M12	200
07091400000Z	M14	200
07091600000Z	M16	100
07091800000Z	M18	50

CÓDIGO	(d)	ENVASE
07092000000Z	M20	50
07092200000Z	M22	50
07092400000Z	M24	50
07092700000Z	M27	25
07093000000Z	M30	25
07093300000Z	M33	25
07093600000Z	M36	10
07093900000Z	M39	5
07094200000Z	M42	5
07090140000Z	1/4"	1000
07090180000Z	1/8"	1000
07093160000Z	3/16"	1000

Consultar disponibilidad en otras medidas y recubrimientos.

0710 DIN 934 C8

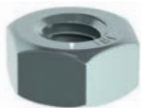
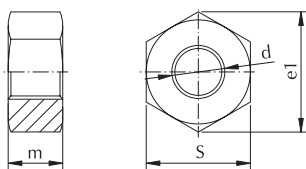

d	M6	M7	M8	M10	M12	M14	M16	M18
m	5	5,5	6,5	8	10	11	13	15
S	10	11	13	17	19	22	24	27
e1	10,9	12	14,3	18,8	20,9	24,2	26,4	29,8

d	M20	M22	M24	M27	M30	M33
m	16	18	19	22	24	26
S	30	32	36	41	46	50
e1	33,2	35,4	39,8	45,2	51,1	55,4

- Tuerca hexagonal de alta resistencia para todo tipo de montajes con varillas roscadas y tornillos métricos.

CÓDIGO	(d)	ENVASE
07100600000Z	M6	1000
07100700000Z	M7	1000
07100800000Z	M8	1000
07101000000Z	M10	500
07101200000Z	M12	200
07101400000Z	M14	200
07101600000Z	M16	100
07101800000Z	M18	100

CÓDIGO	(d)	ENVASE
07102000000Z	M20	50
07102200000Z	M22	50
07102400000Z	M24	50
07102700000Z	M27	25
07103000000Z	M30	25
07103300000Z	M33	25
07100380000Z	3/8"	500

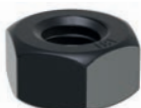

CÓDIGO	(d)	ENVASE
07100600000P	M6	1000
07100700000P	M7	1000
07100800000P	M8	1000
07101000000P	M10	500
07101200000P	M12	200
07101400000P	M14	200
07101600000P	M16	100

CÓDIGO	(d)	ENVASE
07101800000P	M18	100
07102000000P	M20	50
07102200000P	M22	50
07102400000P	M24	50
07102700000P	M27	25
07103000000P	M30	25
07103300000P	M33	25

Consultar disponibilidad en otras medidas.

Medidas en mm.

0740 DIN 934 C10

d	M6	M7	M8	M10	M12	M14	M16	M18
m	5	5,5	6,5	8	10	11	13	15
S	10	11	13	17	19	22	24	27
e1	10,9	12	14,3	18,8	20,9	24,2	26,4	29,8

d	M20	M22	M24	M27	M30	M33
m	16	18	19	22	24	26
S	30	32	36	41	46	50
e1	33,2	35,4	39,8	45,2	51,1	55,4

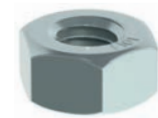
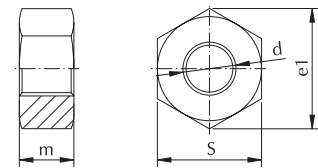

- Tuerca hexagonal de alta resistencia para todo tipo de montajes con varillas roscadas y tornillos métricos.

CÓDIGO	(d)	ENVASE
07400600000Z	M6	500
07400800000Z	M8	500
07401000000Z	M10	200
07401200000Z	M12	200
07401400000Z	M14	200
07401600000Z	M16	100
07401800000Z	M18	100

CÓDIGO	(d)	ENVASE
07402000000Z	M20	50
07402200000Z	M22	50
07402400000Z	M24	50
07402700000Z	M27	25
07403000000Z	M30	25
07403300000Z	M33	10

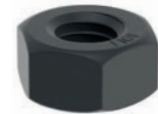

CÓDIGO	(d)	ENVASE
07400600000P	M6	500
07400800000P	M8	500
07401000000P	M10	200
07401200000P	M12	200
07401400000P	M14	200
07401600000P	M16	100
07401800000P	M18	100

CÓDIGO	(d)	ENVASE
07402000000P	M20	50
07402200000P	M22	50
07402400000P	M24	50
07402700000P	M27	25
07403000000P	M30	25
07403300000P	M33	10

0711 DIN 936

d	M4	M5	M6	M8	M10	M12	M14	M16	M18	M20	M24
m	2	3	4	5	6	7	8	8	9	9	10
S	7	8	10	13	17	19	22	24	27	30	36
e1	7,7	8,7	10,9	14,3	18,9	21,1	24,4	26,7	29,5	32,9	39,5

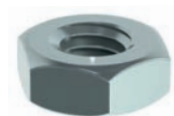
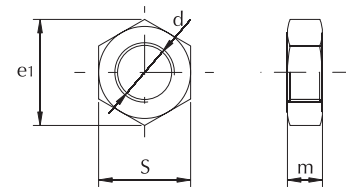

- Tuerca hexagonal baja para todo tipo de montajes con varillas y tornillos métricos.

CÓDIGO	(d)	ENVASE
07110400000Z	M4	1000
07110500000Z	M5	1000
07110600000Z	M6	1000
07110800000Z	M8	1000
07111000000Z	M10	200
07111200000Z	M12	200

CÓDIGO	(d)	ENVASE
07111400000Z	M14	200
07111600000Z	M16	100
07111800000Z	M18	100
07112000000Z	M20	50
07112400000Z	M24	50

Medidas en mm.

0712 DIN 985

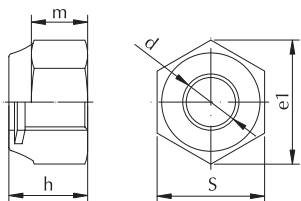

d	M3	M3	M4	M5	M6	M7	M8	M10	M12	M14	M16	M18	M20	M22	M24	M27	M30
m (min.)	2,4	2,4	2,9	3,2	4	4,7	5,5	6,5	8	9,5	10,5	13	14	15	15	17	19
S	5,5	5,5	7	8	10	11	13	17	19	22	24	27	30	32	36	40	46
e1	6	6	7,7	8,9	11	12,1	14,4	18,9	21,1	24,5	26,7	30,1	33,5	35,7	39,9	45,2	51,3
h	4	4	5	5	6	7,5	8	10	12	14	16	18,5	20	22	24	27	30

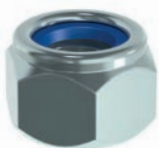

• Tuerca de freno con inserto de plástico.

CÓDIGO	(d)	ENVASE	CÓDIGO	(d)	ENVASE
07120300000Z	M3	1000	07121400000Z	M14	100
07120400000Z	M4	1000	07121600000Z	M16	100
07120500000Z	M5	1000	07121800000Z	M18	50
07120600000Z	M6	1000	07122000000Z	M20	50
07120700000Z	M7	1000	07122200000Z	M22	50
07120800000Z	M8	500	07122400000Z	M24	50
07121000000Z	M10	200	07122700000Z	M27	20
07121200000Z	M12	100	07123000000Z	M30	10

0744 DIN 985 C10

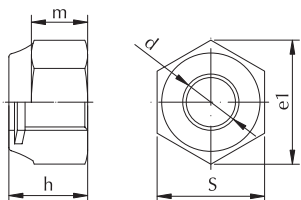

d	M8	M10	M12	M14	M16	M18	M20	M22	M24	M27	M30	M33	M36
m (min.)	5,5	6,5	8	9,5	10,5	13	14	15	15	17	19	22	25
S	13	17	19	22	24	27	30	32	36	41	46	50	55
e1	14,4	18,9	21,1	24,5	26,7	30,1	33,5	35,7	39,9	45,2	51,3	55,3	60,7
h	8	10	12	14	16	18,5	20	22	24	27	30	33	36



• Tuerca de freno de alta resistencia con inserto de plástico.

CÓDIGO	(d)	ENVASE	CÓDIGO	(d)	ENVASE
07440600000Z	M6	1	07442000000Z	M20	75
07440800000Z	M8	500	07442200000Z	M22	60
07441000000Z	M10	500	07442400000Z	M24	40
07441200000Z	M12	350	07442700000Z	M27	30
07441400000Z	M14	200	07443000000Z	M30	20
07441600000Z	M16	150	07443300000Z	M33	15
07441800000Z	M18	100	07443600000Z	M36	12

0717 TUERCA LAMPISTERÍA

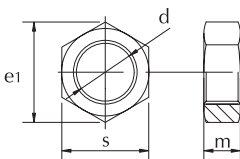

d	M10/100	M10/100
m	3	4
s	13	13
e1	14,5	14,5



• Tuerca hexagonal para montajes en lampistería.

CÓDIGO	(d)	ENVASE	CÓDIGO	(d)	ENVASE
07171000003Z	M10 /100 X 3	1000	07171000004Z	M10 /100 X 4	1000

Medidas en mm.



0715 DIN 557

d	M4	M5	M6	M8	M10
m	3,5	4	5	6,5	8
s	7	8	10	13	16
e1	9,9	11,3	14,1	18,4	22

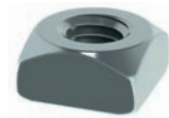
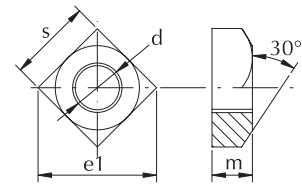

- Tuerca cuadrada para todo tipo de montajes con varillas y tornillos métricos.

CÓDIGO	(d)	ENVASE
07150400000Z	M4	1000
07150500000Z	M5	1000
07150600000Z	M6	1000

CÓDIGO	(d)	ENVASE
07150800000Z	M8	500
07151000000Z	M10	200

0716 DIN 6923

d	M4	M5	M6	M8	M10	M12	M14	M16
m	4,5	5	6	8	10	12	14	16
s	7	8	10	13	15	18	21	24
e1	7,9	8,8	11,1	14,4	16,6	20	23	26,7
dc (máx.)	9,7	11,8	14,2	17,9	21,8	26	29,9	34,5

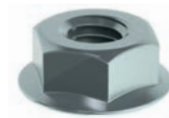
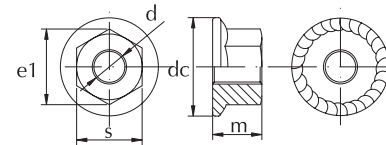

- Tuerca hexagonal con arandela estampada para todo tipo de montajes con varillas y tornillos métricos.
- Las estrías realizan la función de freno, obteniendo un mejor apriete.

CÓDIGO	(d)	ENVASE
07160400000Z	M4	1000
07160500000Z	M5	1000
07160600000Z	M6	500
07160800000Z	M8	500

CÓDIGO	(d)	ENVASE
07161000000Z	M10	200
07161200000Z	M12	100
07161400000Z	M14	100
07161600000Z	M16	100

0736 DIN 929

d	M5	M6	M8	M10	M12	M14	M16
m	4	5	6,5	8	10	11	13
S	10	11	14	17	19	22	24
e	10,95	12,02	15,38	18,74	20,91	24,27	26,51
h1	0,7	0,75	0,9	1,15	1,4	1,8	1,8
h2	0,4	0,4	0,5	0,65	0,8	1	1

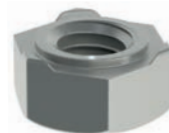
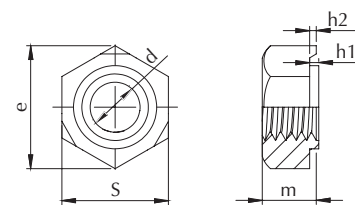

- Tuerca hexagonal para soldar.

CÓDIGO	(d)	ENVASE
07360500000S	M5	2000
07360600000S	M6	2000
07360800000S	M8	1000
07361000000S	M10	500

CÓDIGO	(d)	ENVASE
07361200000S	M12	200
07361400000S	M14	100
07361600000S	M16	100

Medidas en mm.

### 0703 TUERCA EMBUTIR ALLEN HIERRO CON VALONA ESTRIADA

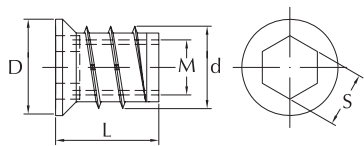

M	M6	M6	M6	M6	M6	M6	M6	M8	M8	M6	M8	M8	M10	M10
d x L	10 x 8	10 x 10	10 x 12	10 x 13	10 x 15	10 x 20	12 x 13	12 x 15	12 x 18	12 x 20	12 x 24	15 x 20	15 x 25	
D	12	12	12	12	12	12	14	14	14	14	14	17	17	
S	6	6	6	6	6	6	8	8	6	8	8	10	10	



- Tuerca de embutir con huella hexagonal para ensamblaje de muebles.
- Rosca con estrías que facilitan la inserción.
- Requiere pretaladro.

CÓDIGO	(d x L)	ENVASE
07030601008Z	M6 10 X 8	5000
07030601010Z	M6 10 X 10	4000
07030601012Z	M6 10 X 12	3500
07030601013Z	M6 10 X 13	4000
07030601015Z	M6 10 X 15	3000
07030601020Z	M6 10 X 20	2000
07030601218Z	M6 12 X 18	2000

CÓDIGO	(d x L)	ENVASE
07030801213Z	M8 12 X 13	2500
07030801215Z	M8 12 X 15	2000
07030801220Z	M8 12 X 20	1500
07030801224Z	M8 12 X 24	1300
07031001520Z	M10 15 X 20	1000
07031001525Z	M10 15 X 25	1000

Útil allen para roscar en página 261.

### 0731 TUERCA EMBUTIR ALLEN HIERRO CON VALONA REDUCIDA Y ESTRIADA

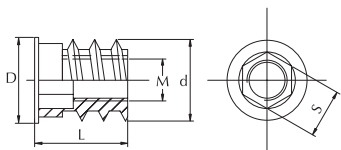

M	M4	M5
d x L	8 x 10	9 x 12
D	8	9
S	4	5



- Tuerca de embutir con huella hexagonal para ensamblaje de muebles.
- Rosca con estrías que facilitan la inserción.
- Requiere pretaladro.

CÓDIGO	(d x L)	ENVASE
07310400810Z	M4 8 X 10	8000

CÓDIGO	(d x L)	ENVASE
07310500912Z	M5 9 X 12	4000

Útil allen para roscar en página 261.

### 0746 TUERCA EMBUTIR CABEZA PLANA ALLEN ROSCA IZQUIERDA

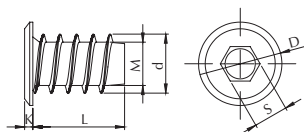

M	M6
d x L	10 x 16
D	15
K	2
S	6



- Tuerca de embutir con huella hexagonal para ensamblaje de muebles.
- Rosca izquierda.
- Requiere pretaladro.

CÓDIGO	(d x L)	ENVASE
07460601016Z	M6 10 X 16	2000

Útil allen para roscar en página 261.

## 0701 TUERCA EMBUTIR ALLEN HIERRO CON VALONA

M	1/4"	1/4"	1/4"	1/4"	1/4"
d x L	10 x 13	10 x 15	12 x 14	12 x 18	12 x 20
D	10,5	10,5	14	14	14
S	6,2	6,2	6,2	6,2	6,2

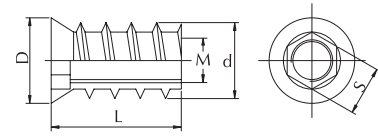

- Tuerca de embutir con huella hexagonal para ensamblaje de muebles.
- Requiere pretaladro.



CÓDIGO	(d x L)	ENVASE
07010141013B	1/4" 10 X 13	500
07010141015B	1/4" 10 X 15	500
07010141214B	1/4" 12 X 14	500

CÓDIGO	(d x L)	ENVASE
07010141218B	1/4" 12 X 18	500
07010141220B	1/4" 12 X 20	500

Útil allen para roscar en página 261.

## 0702 TUERCA EMBUTIR ALLEN HIERRO SIN VALONA

M	M6 - 1/4"	M6 - 1/4"	M6 - 1/4"	M6 - 1/4"	M6 - 1/4"	M8	3/8"	M10
d x L	10 x 13	10 x 15	12 x 14	12 x 18	12 x 20	12 x 20	15 x 17	15 x 17
D	9,2	9,2	10,5	10,5	10,5	10,5	13,5	13,5
S	6,2	6,2	6,2	6,2	6,2	8,3	9,2	10,2

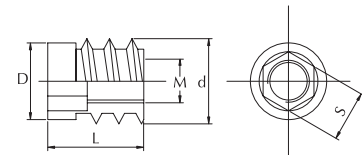

- Tuerca de embutir con huella hexagonal para ensamblaje de muebles.
- Requiere pretaladro.



CÓDIGO	(d x L)	ENVASE
07020601013B	M6 10 X 13	500
07020601015B	M6 10 X 15	500
07020601214B	M6 12 X 14	500
07020601218B	M6 12 X 18	500
07020601220B	M6 12 X 20	500
07020801220B	M8 12 X 20	500
07021001517B	M10 15 X 17	200

CÓDIGO	(d x L)	ENVASE
07020141013B	1/4" 10 X 13	500
07020141015B	1/4" 10 X 15	500
07020141214B	1/4" 12 X 14	500
07020141218B	1/4" 12 X 18	500
07020141220B	1/4" 12 X 20	500
07020381517B	3/8" 15 X 17	200

Útil allen para roscar en página 261.



CÓDIGO	(d x L)	ENVASE
07020601013Z	M6 10 X 13	500

CÓDIGO	(d x L)	ENVASE
07020801220Z	M8 12 X 20	500

Útil allen para roscar en página 261.

### 0743 TUERCA EMBUTIR CON RANURA Y SIN VALONA

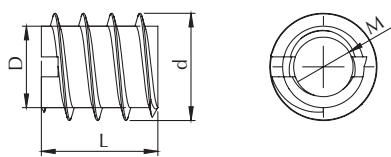

M	1/4"	1/4"	M10
d x L	10 x 12	10 x 16	15 x 17
D	8	8	11,5

- Tuerca de embutir con ranura para ensamblaje de muebles.
- Requiere pretaladro.

CÓDIGO	(d x L)	ENVASE
07431001517B	M10 15 X 17	250
07430141012B	1/4" 10 X 12	400

CÓDIGO	(d x L)	ENVASE
07430141016B	1/4" 10 X 16	500

### 0704 TUERCA ÉMBOLO DOBLE

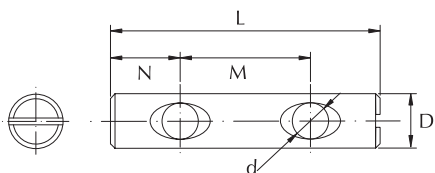

d	M8	M8
D x L	12 x 60	12 x 70
N	14	15
M	32	40

- Tuerca émbolo con dos agujeros roscados para ensamblaje de muebles, particularmente mesas.

CÓDIGO	(D x L)	ENVASE
07040801260Z	M8 12 X 60	500

CÓDIGO	(D x L)	ENVASE
07040801270Z	M8 12 X 70	300

### 0705 TUERCA ÉMBOLO HIERRO

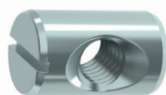
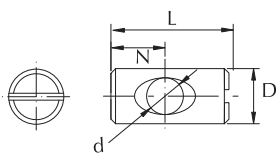

d	M5	1/4"	M6	M6 - 1/4"	1/4"	M8	M8	M8	M8
D x L	10 x 13	10 x 13	10 x 13	10 x 15	10 x 19	12 x 19	12 x 30	12 x 40	12 x 53
N	6	5,5	6,5	5,5	6	9	15	14	14

- Tuerca émbolo con agujero roscado para ensamblaje de muebles.

CÓDIGO	(D x L)	ENVASE
07050601013Z	M6 10 X 13	1000
07050601015Z	M6 10 X 15	1000
07050801219Z	M8 12 X 19	1000
07050801230Z	M8 12 X 30	200

CÓDIGO	(D x L)	ENVASE
07050801240Z	M8 12 X 40	200
07050141013Z	1/4" 10 X 13	1000
07050141015Z	1/4" 10 X 15	1000
07050141019Z	1/4" 10 X 19	2000



CÓDIGO	(D x L)	ENVASE
07050501013B	M5 10 X 13	500

CÓDIGO	(D x L)	ENVASE
07050801253B	M8 12 X 53	200

Medidas en mm.

**0718 TUERCA 4 PÚAS**

d	M4	M5	M6	M8	M10	1/4"
d1	5	6	7,5	9	11	8
L	6	8	8	10	11	8
m	7	8	9	11	12,5	9
t	15	18	19	22	25,5	19

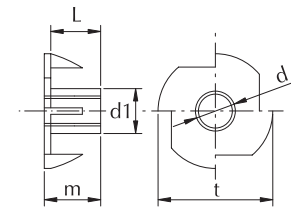

- Tuerca para clavar en madera con 4 dientes.

CÓDIGO	(d)	ENVASE
07180400000Z	M4	500
07180500000Z	M5	500
07180600000Z	M6	500

CÓDIGO	(d)	ENVASE
07180800000Z	M8	500
07181000000Z	M10	200
07180140000Z	1/4"	500

**0734 TUERCA 4 PÚAS SIN ROSCAR**

d	5,4	7,1	8,9
A	19	22	25
B	9	11	13
C	7,6	9,4	11,3
D	7	7,3	8,6
T	1,3	1,35	1,7

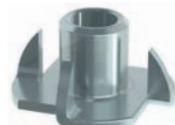
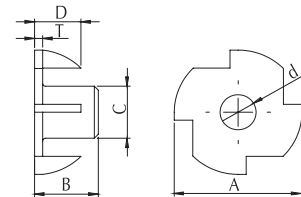

- Tuerca para clavar en madera con 4 dientes.
- No lleva rosca interior.

CÓDIGO	(d)	ENVASE
07340600000Z	M6	500
07340800000Z	M8	500

CÓDIGO	(d)	ENVASE
07341000000Z	M10	200

**0762 TUERCA 4 PÚAS DENTADA**

d	M6	M8	M10
D	8	10	12
A	22	22	22

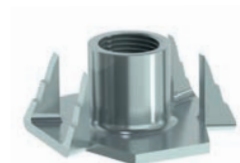
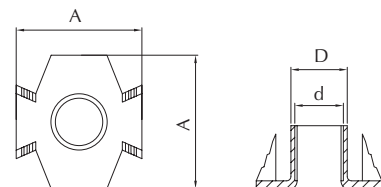

CÓDIGO	(d)	ENVASE
07620600000Z	M6	500
07620800000Z	M8	500

CÓDIGO	(d)	ENVASE
07621000000Z	M10	200

Medidas en mm.

### 0763 TUERCA 4 PÚAS DENTADA REDUCIDA

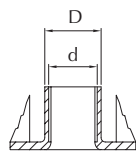
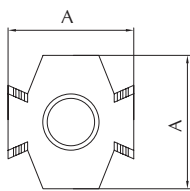

d	M6
D	8
A	17

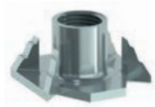

CÓDIGO	(d)	ENVASE
07630600000Z	M6	500

### 0719 INSERTO ARPÓN

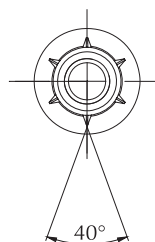
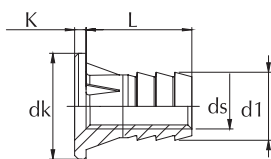

d	M6	M8
dk	14	19
ds	8,3	10,4
d1	9	11
K	1,5	2,5
L	14	16



- Tuerca para clavar en madera con cuerpo estriado.

CÓDIGO	(d)	ENVASE
07190600000Z	M6	2500

CÓDIGO	(d)	ENVASE
07190800000Z	M8	1000

### 0720 INSERTO ARPÓN CON VALONA

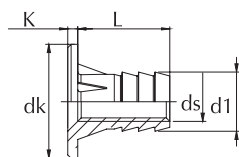

d	M6
dk	17
ds	8,3
d1	9
K	1,5
L	14



- Tuerca para clavar en madera con cuerpo estriado.

CÓDIGO	(d)	ENVASE
07200600000Z	M6	2000

Medidas en mm.

## 0721 TUERCA ENJAULADA

d	M3 (1,0-1,6)	M3 (1,7-2,3)	M4 (0,5-1,5)	M4 (1,0-1,6)	M6 (0,5-1,5)
D	9,3	9,3	12	9,3	12
A	4,8	4,8	7,2	4,8	7,2
F	9,7	9,7	12,2	9,7	12,2
G	3,6	3,6	6	3,6	6

d	M6 (1,6-2,5)	M8 (1-1,7)	M8 (1,8-3,2)	M10 (1,8-3,2)
D	12	16	16	16
A	7,2	10,6	10,6	10,6
F	12,2	16,6	16,6	16,6
G	6	7,8	7,8	7,8

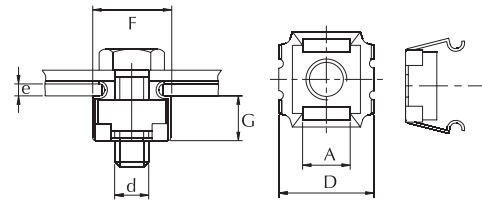

- Tuerca cuadrada con jaula inoxidable para montajes en todo tipo de paneles en amplios intervalos de espesor.
- Se inserta en alojamiento rectangular o cuadrado sin necesidad de utilajes especiales.



CÓDIGO	(d)	ENVASE
07210301016Z	M3 (1,0 - 1,6)	500
07210301723Z	M3 (1,7 - 2,3)	500
07210400515Z	M4 (0,5 - 1,5)	500
07210401016Z	M4 (1,0 - 1,6)	500
07210600515Z	M6 (0,5 - 1,5)	200

CÓDIGO	(d)	ENVASE
07210601625Z	M6 (1,6 - 2,5)	200
07210801017Z	M8 (1,0 - 1,7)	100
07210801832Z	M8 (1,8 - 3,2)	100
07211001832Z	M10 (1,8 - 3,2)	100

## 0722 PALOMILLA

d	M3	M4	M5	M6	M8	M10	M12	M14	M16
d1	8	8	10	12	16	20	23	25	25

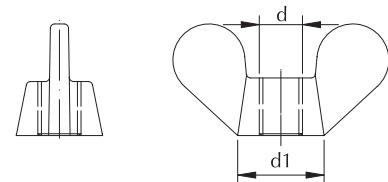

- Tuerca palomilla con aletas para apriete manual.

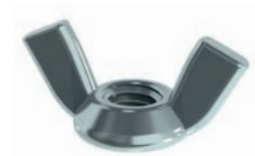

CÓDIGO	(d)	ENVASE
07220300000Z	M3	500
07220400000Z	M4	500
07220500000Z	M5	500
07220600000Z	M6	500
07220800000Z	M8	250

CÓDIGO	(d)	ENVASE
07221000000Z	M10	200
07221200000Z	M12	100
07221400000Z	M14	50
07221600000Z	M16	25
07223160000Z	3/16"	500

**0706 TUERCA REMACHABLE GRAFILADA CON VALONA**

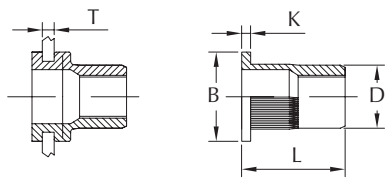

d	M4	M5	M6	M8	M10
D	4,9	6,9	8,9	10,9	12,9
B	8	10	12,3	14,5	17
K	0,8	1	1,3	1,5	1,7
L	10,5	13	15,5	18,5	21,5
Ø taladro	6	7	9	11	13
Espesor chapa T	0,5 - 1,5	0,5 - 2,5	0,5 - 3,0	1,0 - 3,5	1,0 - 4,0

- Tuerca remachable con cuerpo grafilado.

CÓDIGO	(d)	ENVASE
07060400000Z	M4	500
07060500000Z	M5	500
07060600000Z	M6	500

CÓDIGO	(d)	ENVASE
07060800000Z	M8	500
07061000000Z	M10	250

**0707 TUERCA REMACHABLE GRAFILADA SIN VALONA**

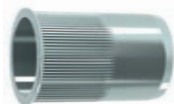
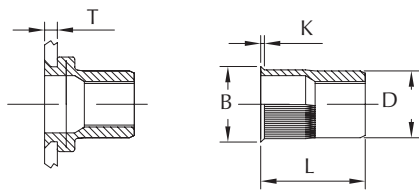

d	M4	M5	M6	M8
D	5,9	6,9	8,9	10,9
B	7	8	10	12
K	0,5	0,5	0,6	0,6
L	11,2	11,5	14	16,5
Ø taladro	6	7	9	11
Espesor chapa T	0,5 - 2,0	0,5 - 2,0	0,5 - 2,5	1,0 - 3,0

- Tuerca remachable con cuerpo grafilado.

CÓDIGO	(d)	ENVASE
07070400000Z	M4	500
07070500000Z	M5	500

CÓDIGO	(d)	ENVASE
07070600000Z	M6	500
07070800000Z	M8	500

**0708 TUERCA REMACHABLE CUERPO HEXAGONAL**

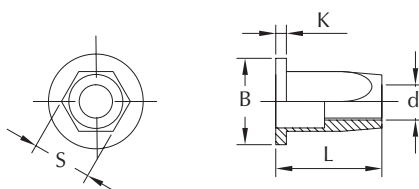

d	M6	M8	M10	M12
S	9	11	13	16
B	12,5	16	18	23
K	1,5	1,5	1,8	2
L	16	18	21	24
Ø taladro	9	11	13	16
Espesor chapa	0,5 - 1,0	1,0 - 2,5	1,0 - 3,0	1,0 - 3,5

- Tuerca remachable hexagonal.

CÓDIGO	(d)	ENVASE
07080600000Z	M6	500
07080800000Z	M8	500

CÓDIGO	(d)	ENVASE
07081000000Z	M10	500
07081200000Z	M12	250

Medidas en mm.



0724 DIN 1587

d	M4	M5	M6	M8	M10	M12	M14	M16	M20	M30
m	8	10	12	15	18	22	25	28	34	52
n	3,2	4	5	6,5	8	10	11	13	16	24
s	7	8	10	13	16	18	21	24	30	46
e1	7,6	8,8	11,1	14,4	17,8	20	23,4	26,8	33,5	52

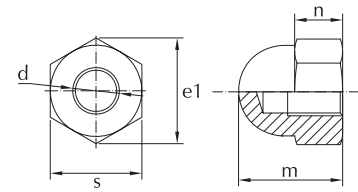

- Tuerca ciega para diferentes aplicaciones, sanitarios, fontanería, mobiliario.



CÓDIGO	(d)	ENVASE
07240300000Z	M3	1000
07240400000Z	M4	1000
07240500000Z	M5	1000
07240600000Z	M6	500
07240800000Z	M8	500
07241000000Z	M10	200

CÓDIGO	(d)	ENVASE
07241200000Z	M12	100
07241400000Z	M14	50
07241600000Z	M16	50
07241800000Z	M18	50
07242000000Z	M20	25
07243000000Z	M30	10

0723 TUERCA CIEGA LATÓN

d	M3	M4	M5	M6	M8	M10	M12	3/8"
m	5,5	6,5	7	9	11	13	17	13
n	3	3,5	3,5	5	6,5	7	9	7
s	6	7	8	10	12	14	19	14
e1	6,7	8	9	11	13,5	16	21,5	16

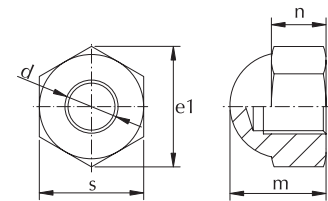

- Tuerca ciega para diferentes aplicaciones, sanitarios, fontanería, mobiliario.
- Cuerpo de latón.

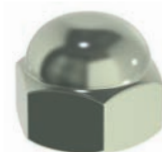

CÓDIGO	(d)	ENVASE
07230300000Q	M3	1000
07230400000Q	M4	1000
07230500000Q	M5	1000
07230600000Q	M6	1000
07230800000Q	M8	500

CÓDIGO	(d)	ENVASE
07231000000Q	M10	200
07231200000Q	M12	200
07231600000Q	M16	100
07230380000Q	3/8"	200

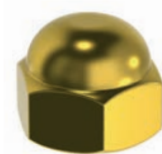

CÓDIGO	(d)	ENVASE
07230300000T	M3	1000
07230400000T	M4	1000
07230500000T	M5	1000
07230600000T	M6	1000

CÓDIGO	(d)	ENVASE
07230800000T	M8	500
07231000000T	M10	200
07231200000T	M12	200
07230380000T	3/8"	200

Medidas en mm.

0713 DIN 986

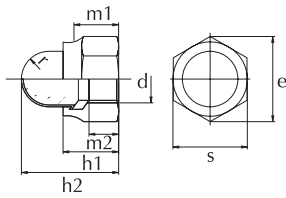

d	M5	M6	M8
e	9,2	11,5	15
h1	6	7,5	8,9
h2	10,5	12	14
m1	4	5	6,4
m2	3,2	4	5,5
r	3	3,5	4,6
s	8	10	13

- Tuerca de freno con capuchón de plástico.

CÓDIGO	(d)	ENVASE
0713050000Z	M5	1000
0713060000Z	M6	1000

CÓDIGO	(d)	ENVASE
0713080000Z	M8	1000

0714 DIN 980 V

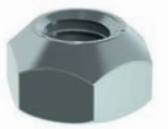
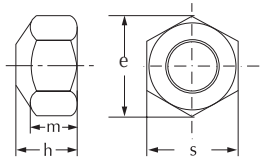

d	M5	M6	M8	M10	M12	M14	M16
h	5	6	8	10	12	14	16
m	2,75	3,3	4,4	5,5	6,6	7,7	8,8
s	8	10	13	17	19	22	24
e	8,79	11,05	14,38	18,9	21,1	24,49	26,75

- Tuerca de freno hexagonal forma V.

CÓDIGO	(d)	ENVASE
0714050000Z	M5	1000
0714060000Z	M6	1000
0714080000Z	M8	500
0714100000Z	M10	500

CÓDIGO	(d)	ENVASE
0714120000Z	M12	200
0714140000Z	M14	100
0714160000Z	M16	100

Medidas en mm.

## 0726 TUERCA POMO LATÓN

e	M4
d	6,5
L	8

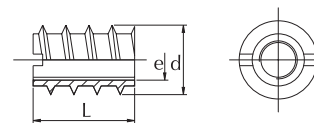

- Tuerca de embutir de latón ranurada.
- Cuerpo de latón.



CÓDIGO	(d x L)	ENVASE
07260400608T	M4 6,5 X 8	1000

## 0730 INSERTO HEXAGONAL LATÓN

d	M4
m	8
s	6
e	6,9

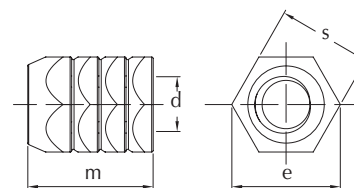

- Tuerca de embutir hexagonal.
- Cuerpo de latón.

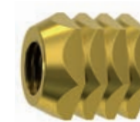

CÓDIGO	(d)	ENVASE
07300400000T	M4	1000

**0727 TUERCA EXPANSIBLE LATÓN**

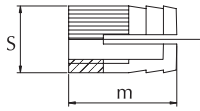

d (S x m)	M4 5 x 8
m	8
S	5



- Tuerca de embutir expansible.
- Cuerpo de latón.

CÓDIGO	(d)	ENVASE
07270400508T	M4 5 X 8	1000

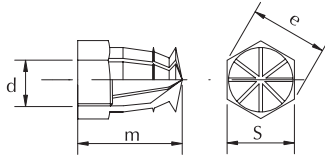

d (S x m)	M6 8 x 9	M6 8 x 12	M8 10 x 13
m	9	12	13
S	8	8	10
e	9	9	11,5



- Tuerca de embutir expansible.
- Cuerpo de latón.

CÓDIGO	(d)	ENVASE
07270600809T	M6 8 X 9	1000
07270600812T	M6 8 X 12	1000

CÓDIGO	(d)	ENVASE
07270801013T	M8 10 X 13	500

**0728 TUERCA EXPANSIBLE LATÓN CON BOLA PLÁSTICO**

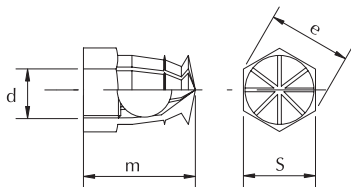

d (S x m)	M6 8 x 9	M6 8 x 12
m	9	12
S	8	8
e	9	9



- Tuerca de embutir expansible con inserto de plástico.
- Cuerpo de latón.

CÓDIGO	(d)	ENVASE
07280600809T	M6 8 X 9	1000

CÓDIGO	(d)	ENVASE
07280600812T	M6 8 X 12	1000

Medidas en mm.

## 0725 TUERCA EXPANSIBLE ZAMAK

D	1/4"
d	22
L	22

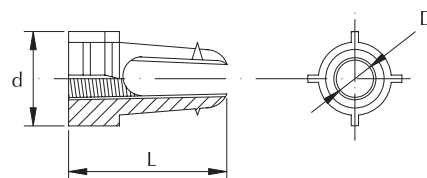

- Tuerca para clavar expansible.



CÓDIGO	(d)	ENVASE
07250140000K	1/4"	500

## 0729 TUERCA CAMA

d	3/8"
m	15
L	20
h	5,4

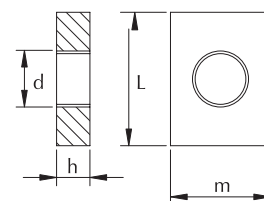

- Tuerca cuadrada para montaje con el tornillo cama.

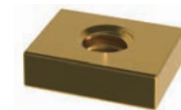

CÓDIGO	(d)	ENVASE
07290380000B	3/8"	500



**CONSULTA  
NUESTRA GAMA DE  
BRIDAS DE NYLON  
EN PÁGINA 227.**



ARANDELAS

08

0801 DIN 125 FORMA A

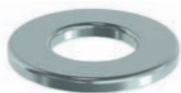
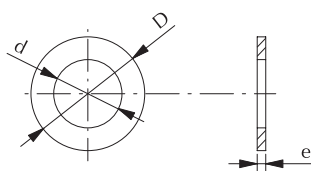

Medida	M3	M4	M5	M6	M7	M8	M10	M12	M14	M16
d	3,2	4,3	5,3	6,4	7,4	8,4	10,5	13	15	17
D	7	9	10	12,5	14	17	21	24	28	30
e	0,5	0,8	1	1,6	1,6	1,6	2	2,5	2,5	3

Medida	M18	M20	M22	M24	M27	M30	M33	M36	M39	M42
d	19	21	23	25	28	31	34	37	40	43
D	34	37	39	44	50	56	60	66	72	78
e	3	3	3	4	4	4	5	5	6	7

- Arandela plana de ala pequeña.

CÓDIGO	MEDIDA	ENVASE
0801030000Z	M3	1000
0801040000Z	M4	1000
0801050000Z	M5	1000
0801060000Z	M6	1000
0801070000Z	M7	1000
0801080000Z	M8	1000
0801100000Z	M10	1000
0801120000Z	M12	500
0801140000Z	M14	500
0801160000Z	M16	100

CÓDIGO	MEDIDA	ENVASE
0801180000Z	M18	100
0801200000Z	M20	200
0801220000Z	M22	50
0801240000Z	M24	50
0801270000Z	M27	25
0801300000Z	M30	50
0801330000Z	M33	50
0801360000Z	M36	50
0801390000Z	M39	25
0801420000Z	M42	25

0823 DIN 125 FORMA A HV 300

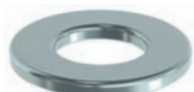
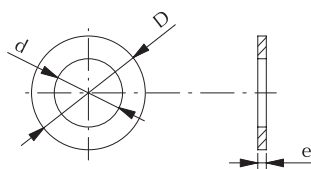

Medida	M6	M8	M10	M12	M14	M16	M18	M20	M27	M30
d	6,4	8,4	10,5	13	15	17	19	21	28	31
D	12,5	17	21	24	28	30	34	37	50	56
e	1,6	1,6	2	2,5	2,5	3	3	3	4	4

- Arandela plana de alta resistencia de ala pequeña.

CÓDIGO	MEDIDA	ENVASE
0823060000Z	M6	2000
0823080000Z	M8	1000
0823100000Z	M10	1000
0823120000Z	M12	500
0823140000Z	M14	500

CÓDIGO	MEDIDA	ENVASE
0823160000Z	M16	250
0823180000Z	M18	250
0823200000Z	M20	200
0823270000Z	M27	100
0823300000Z	M30	100



CÓDIGO	MEDIDA	ENVASE
0823060000P	M6	2000
0823080000P	M8	1000
0823100000P	M10	1000
0823120000P	M12	500
0823140000P	M14	500
0823160000P	M16	250

CÓDIGO	MEDIDA	ENVASE
0823180000P	M18	250
0823200000P	M20	200
0823220000P	M22	200
0823240000P	M24	200
0823270000P	M27	100
0823300000P	M30	100

Medidas en mm.



## 0802 DIN 9021

Medida	M3	M4	M5	M6	M7	M8	M10	M12
d	3,2	4,3	5,3	6,4	7,4	8,4	10,5	13
D	9	12	15	18	22	25	30	37
C	0,8	1	1,5	1,5	2	2	2,5	3

Medida	M14	M16	M18	M20	M22	M24	M27	M30
d	15	17	20	22	24	26	29	33
D	45	50	56	59	66	72	80	90
C	3	3	4	4	4	4	5	5

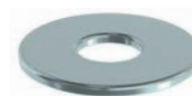
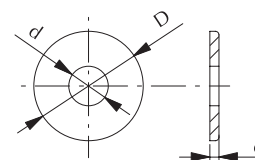

- Arandela plana de ala ancha.

CÓDIGO	MEDIDA	ENVASE	CÓDIGO	MEDIDA	ENVASE
08020300000Z	M3	1000	08021400000Z	M14	200
08020400000Z	M4	1000	08021600000Z	M16	100
08020500000Z	M5	1000	08021800000Z	M18	50
08020600000Z	M6	1000	08022000000Z	M20	50
08020700000Z	M7	500	08022200000Z	M22	25
08020800000Z	M8	500	08022400000Z	M24	50
08021000000Z	M10	200	08022700000Z	M27	25
08021200000Z	M12	200	08023000000Z	M30	10

## 0803 ARANDELA ESTÁNDAR

d	6	7	8	9	11	13	16
D	14	16	18	20	24	28	34
e	1	1,5	1,5	1,5	2	2	3

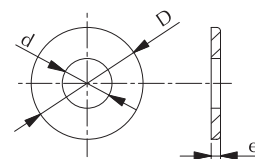

- Arandela plana de ala especial.

CÓDIGO	MEDIDA	ENVASE	CÓDIGO	MEDIDA	ENVASE
08030600000Z	6	1000	08031100000Z	11	1000
08030700000Z	7	1000	08031300000Z	13	1000
08030800000Z	8	1000	08031600000Z	16	500
08030900000Z	9	1000			



CÓDIGO	MEDIDA	ENVASE
08030600000B	6	1000

0804 DIN 127 FORMA B

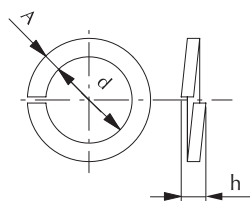

Medida	M3	M4	M5	M6	M7	M8	M10	M12
d	3,1	4,1	5,1	6,1	7,1	8,1	10,2	12,2
A	1,3	1,5	1,8	2,5	2,5	3	3,5	4
h	1,6	1,8	2,4	3,2	3,2	4	4,4	5

Medida	M14	M16	M18	M20	M22	M24	M27	M30
d	14,2	16,2	18,2	20,2	22,5	24,5	27,5	30,5
A	4,5	5	5	6	6	7	7	8
h	6	7	7	8	8	10	10	12

• Arandela grower de sección rectangular.

CÓDIGO	MEDIDA	ENVASE
0804030000Z	M3	1000
0804040000Z	M4	1000
0804050000Z	M5	1000
0804060000Z	M6	1000
0804070000Z	M7	1000
0804080000Z	M8	1000
0804100000Z	M10	1000
0804120000Z	M12	1000

CÓDIGO	MEDIDA	ENVASE
0804140000Z	M14	500
0804160000Z	M16	200
0804180000Z	M18	200
0804200000Z	M20	200
0804220000Z	M22	100
0804240000Z	M24	100
0804270000Z	M27	50
0804300000Z	M30	50



CÓDIGO	MEDIDA	ENVASE
0804030000P	M3	1000
0804040000P	M4	1000
0804050000P	M5	1000
0804060000P	M6	1000
0804070000P	M7	1000
0804080000P	M8	1000

CÓDIGO	MEDIDA	ENVASE
0804100000P	M10	1000
0804120000P	M12	1000
0804140000P	M14	500
0804160000P	M16	200
0804200000P	M20	200
0804240000P	M24	100

Medidas en mm.

## 0805 DIN 7980

Medida	M3	M4	M5	M6	M7	M8	M10	M12	M14
d	3,3	4,1	4,5	6,1	7,1	8,1	10,2	12,2	14,2
A	1	1,2	1,6	1,6	1,6	2	2,5	2,5	3
h	1,1	2,4	3,2	3,2	3,2	4	5	5	6

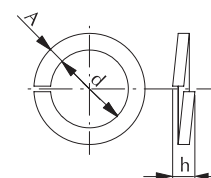

- Arandela grower de sección cuadrada.



CÓDIGO	MEDIDA	ENVASE
08050300000Z	M3	1000
08050400000Z	M4	1000
08050500000Z	M5	1000
08050600000Z	M6	1000

CÓDIGO	MEDIDA	ENVASE
08050800000Z	M8	1000
08051000000Z	M10	1000
08051200000Z	M12	500



CÓDIGO	MEDIDA	ENVASE
08050300000P	M3	1000
08050400000P	M4	1000
08050500000P	M5	1000
08050600000P	M6	1000
08050700000P	M7	1000

CÓDIGO	MEDIDA	ENVASE
08050800000P	M8	1000
08051000000P	M10	1000
08051200000P	M12	500
08051400000P	M14	500

## 0806 SUJECIÓN RÁPIDA CIRCULAR PARA EJES

Medida	2	3	4	5	6	7	8	9	10	12	14
D	7	7,3	10	11	13	14	16	17	16	22	24
S	0,2	0,3	0,3	0,3	0,3	0,3	0,3	0,3	0,3	0,4	0,4
K	0,7	0,8	0,8	0,9	1	1	1,2	1,4	1,4	1,4	1,4

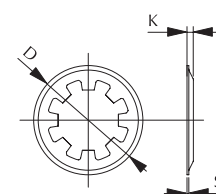

- Se utiliza para sujeciones que no necesitan grandes esfuerzos, especialmente mecanismos eléctricos, contadores, aparatos de medida.
- Acero para muelles HRC 40-47 (HV 390-470)



CÓDIGO	MEDIDA	ENVASE
08060200000Z	2	1000
08060300000Z	3	1000
08060400000Z	4	1000
08060500000Z	5	1000
08060600000Z	6	1000
08060700000Z	7	1000

CÓDIGO	MEDIDA	ENVASE
08060800000Z	8	1000
08060900000Z	9	1000
08061000000Z	10	1000
08061200000Z	12	500
08061400000Z	14	500

0810 ARANDELA LAMPARERA

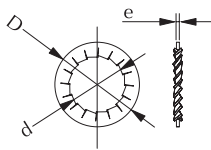

d	10,5
D	14,5
e	1,3



- Arandela dentada para lampistería.

CÓDIGO	(d)	ENVASE
08101050000S	10,5	1000

0807 DIN 6798 FORMA A

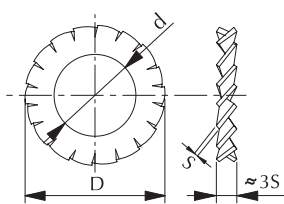

d	3,2	4,3	5,1	5,3	6,4	7,4	8,2	10,5	13	15	17	19	21
D	6	8	9	9	11	13	14	18	21	24	26	30	33
S	0,4	0,5	0,5	0,5	0,7	0,8	0,8	0,9	1	1	1,2	1,4	1,4
rosca M	3	4	5	5	6	7	8	10	12	14	16	18	20
rosca W	1/8"	5/35"	3/16"	3/16"	1/4"		5/16"	3/8"		9/16"	5/8"		3/4"



- Arandela dentada en abanico con función antivibratoria.
- La forma A permite un contacto uniforme de todos los dientes sobre el diámetro mayor, ofreciendo la máxima resistencia al aflojamiento.
- Acero para muelles HRC 36-43 (HV 350-425).
- Aceitado antioxidante

CÓDIGO	MEDIDA	ENVASE
08070320000Z	3,2	1000
08070430000Z	4,3	1000
08070510000Z	5,1	1000
08070530000Z	5,3	1000

CÓDIGO	MEDIDA	ENVASE
08070640000Z	6,4	1000
08070740000Z	7,4	1000
08070820000Z	8,2	1000
08071050000Z	10,5	500



CÓDIGO	MEDIDA	ENVASE
08070320000S	3,2	1000
08070430000S	4,3	2000
08070510000S	5,1	1500
08070640000S	6,4	1000
08070740000S	7,4	1000
08070820000S	8,2	1000

CÓDIGO	MEDIDA	ENVASE
08071050000S	10,5	1000
08071300000S	13	500
08071500000S	15	400
08071700000S	17	500
08071900000S	19	300
08072100000S	21	250

Medidas en mm.

## 0808 DIN 6798 FORMA J

d	3,2	4,3	5,1	6,4	7,4	8,2	10,5
D	6	8	9	11	12,5	14	18
S	0,4	0,5	0,5	0,7	0,8	0,8	0,9
rosca M	3	4	5	6	7	8	10
rosca W	1/8"	5/35"	3/16"		5/32"	5/16"	3/8"

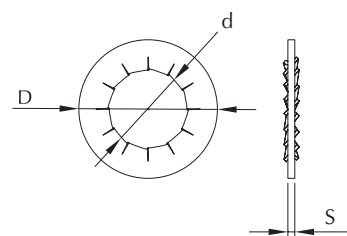

- Arandela dentada en abanico con función antivibratoria.
- Forma J se emplea cuando la superficie de la pieza a fijar sea irregular o de forma abombada.
- Acero para muelles HRC 36-43 (HV 350-425).
- Aceitado antioxidante



CÓDIGO	MEDIDA	ENVASE
08080320000S	3,2	5000
08080430000S	4,3	2500
08080510000S	5,1	1750
08080640000S	6,4	2000

CÓDIGO	MEDIDA	ENVASE
08080740000S	7,4	1250
08080820000S	8,2	1000
08081050000S	10,5	1000

## 0809 DIN 6798 FORMA V

d	3,2	4,3	5,3	6,4	8,4	10,5	13	15	17
D	6	8	9,8	11,8	15,3	19	23	26,2	30
S	0,2	0,25	0,3	0,4	0,4	0,5	0,5	0,6	0,6
rosca M	3	4	5	6	8	10	12	14	16
rosca W	1/8"	5/32"	3/16"	1/4"	5/16"	3/8"	1/2"	9/16"	5/8"

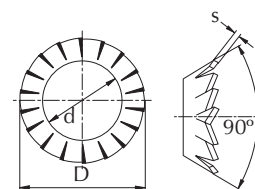

- Arandela dentada en abanico con función antivibratoria.
- La forma V se utiliza en tornillos con cabeza de 90°.
- Acero para muelles HRC 36-43 (HV 350-425).
- Aceitado antioxidante



CÓDIGO	MEDIDA	ENVASE
08090320000S	3,2	4000
08090430000S	4,3	3500
08090530000S	5,3	2500
08090640000S	6,4	1250
08090840000S	8,4	1250

CÓDIGO	MEDIDA	ENVASE
08091050000S	10,5	1000
08091300000S	13	500
08091500000S	15	400
08091700000S	17	250

0821 DIN 6797 FORMA A

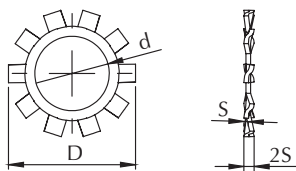

d	3,2	4,3	5,3	6,4	7,4	8,4	10,5	13	15	17	21
D	6	8	10	11	12,5	15	18	20,5	24	26	33
S	0,4	0,5	0,5	0,7	0,8	0,8	0,9	1	1	1,2	1,4
rosca M	3	4	5	6	7	8	10	12	14	16	20
rosca W	1/8"	5/32"	3/16"	1/4"	9/32"	5/16"	3/8"				



- Permite inmovilizar elementos de unión como tornillos y pernos sujetos a vibraciones, manteniendo uniforme el par de apriete aplicado sobre el elemento de fijación en cualquier montaje mecánico, eléctrico y electrónico.
- Además de su función antivibratoria permite mejorar la calidad de los circuitos eléctricos al constituir cada diente un excelente punto de contacto.
- La forma A, al disponer el dentado en la parte exterior, permite un contacto uniforme de todos los dientes sobre el diámetro mayor, ofreciendo la máxima resistencia al aflojamiento.
- La superficie de la pieza a fijar debe ser plana y perpendicular al eje de los tornillos.

CÓDIGO	MEDIDA	ENVASE
08210320000S	3,2	7000
08210430000S	4,3	2500
08210530000S	5,3	1500
08210640000S	6,4	2500
08210740000S	7,4	1000
08210840000S	8,4	1000

CÓDIGO	MEDIDA	ENVASE
08211050000S	10,5	1000
08211300000S	13	900
08211500000S	15	500
08211700000S	17	600
08212100000S	21	500

0811 ARANDELA ESPECIAL TORNILLO DIN 912

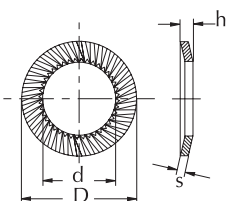

d	3,2	4,3	5,3	6,4	8,4	10,5	13	15	17
D	5,5	7	9	10	13	16	18	21	24
h máx.	0,85	0,95	1,05	1,2	1,4	1,6	1,7	2	2,1
S	0,45	0,5	0,6	0,7	0,8	1	1	1,2	1,2
rosca M	3	4	5	6	8	10	12	14	16



- Arandela estriada para tornillos de cabeza cilíndrica.
- Acero para muelles HRC 43-49 (HV 425-495)

CÓDIGO	MEDIDA	ENVASE
08110320000S	3,2	6000
08110430000S	4,3	4000
08110530000S	5,3	2000
08110640000S	6,4	1000
08110840000S	8,4	1000

CÓDIGO	MEDIDA	ENVASE
08111050000S	10,5	1000
08111300000S	13	500
08111500000S	15	500
08111700000S	17	500

## 0812 ARANDELA DENTADA DOBLE

d	4,5	5,5	6,5	8,5	10,5	13
D	14	17	20,5	23	26	31
e	0,5	0,5	0,6	0,8	1	1,1

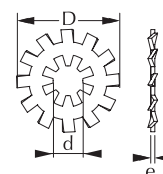

- Arandela de doble dentado para agujeros muy superiores al diámetro del tornillo.
- Acero para muelles HRC 43-49 (HV 425-495)



CÓDIGO	MEDIDA	ENVASE
08120450000S	4,5	1000
08120550000S	5,5	1000
08120650000S	6,5	1000

CÓDIGO	MEDIDA	ENVASE
08120850000S	8,5	1000
08121050000S	10,5	1000
08121300000S	13	500

## 0820 DIN 137 FORMA B

d	3,7	4,3	5,3	6,4	7,4	8,4	10,5	13	15	17	19
D	8	9	11	12	14	15	21	24	28	30	34
h mín.	0,9	1	1,1	1,3	1,5	1,5	2,1	2,5	3	3,2	3,3
h máx.	1,8	2	2,2	2,6	3	3	4,2	5	5,9	6,3	6,5

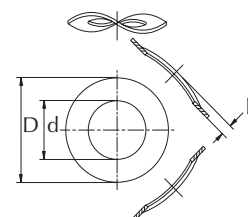

- Arandela de muelle para montajes con pares de apriete elevados.
- Acero para muelles HRC 44-51 (HV 430-530)



CÓDIGO	MEDIDA	ENVASE
08200370000S	3,7	2000
08200430000S	4,3	2000
08200530000S	5,3	500
08200640000S	6,4	1000
08200740000S	7,4	1500
08200840000S	8,4	1250

CÓDIGO	MEDIDA	ENVASE
08201050000S	10,5	1000
08201300000S	13	750
08201500000S	15	350
08201700000S	17	300
08201900000S	19	250

0813 DIN 6799

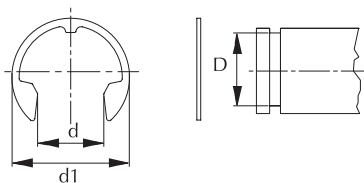

D	2,3	3,2	4	5	6	7	8	9	10	12	15	19	24
d	1,94	2,7	3,34	4,11	5,26	5,84	6,52	7,63	8,32	10,45	12,61	15,92	21,88
d1 mín.	3	4	5	6	7	8	9	10	11	13	16	20	25
d1 máx.	4	5	7	8	9	11	12	14	15	18	24	31	38



- Arandela de seguridad para ejes de diámetro pequeño.
- Acero para muelles HRC 46-54 (HV 460-580)

CÓDIGO	MEDIDA	ENVASE
08130230000S	2,3	5000
08130320000S	3,2	5000
08130400000S	4	2500
08130500000S	5	2500
08130600000S	6	2500
08130700000S	7	2500
08130800000S	8	2000

CÓDIGO	MEDIDA	ENVASE
08130900000S	9	1000
08131000000S	10	1000
08131200000S	12	1000
08131500000S	15	500
08131900000S	19	250
08132400000S	24	200

0814 ANILLO DE SEGURIDAD DIN 471

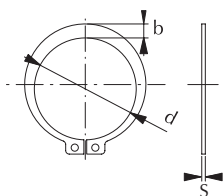

Medida	5	6	7	8	9	10	11	12	13	14	15	16	17
d	4,7	5,6	6,5	7,4	8,4	9,3	10,2	11	11,9	12,9	13,8	14,7	15,7
b	1,1	1,3	1,4	1,5	1,7	1,8	1,8	1,8	2	2,1	2,2	2,2	2,3
S	0,6	0,7	0,8	0,8	1	1	1	1	1	1	1	1	1

Medida	18	19	20	21	22	24	25	26	28	29	30
d	16,5	17,5	18,5	19,5	20,5	22,2	23,2	24,2	25,9	26,9	27,9
b	2,4	2,5	2,6	2,7	2,8	3	3	3,1	3,2	3,4	3,5
S	1,2	1,2	1,2	1,2	1,2	1,2	1,2	1,2	1,5	1,5	1,5



- Elemento de seguridad para sujetar diversas piezas a ejes.
- Acero para muelles HRC 44-54 (HV 435-580)

CÓDIGO	MEDIDA	ENVASE
08140500000F	E-5	2500
08140600000F	E-6	5000
08140700000F	E-7	1000
08140800000F	E-8	1000
08140900000F	E-9	1000
08141000000F	E-10	1000
08141100000F	E-11	1000
08141200000F	E-12	1000
08141300000F	E-13	1000
08141400000F	E-14	1000
08141500000F	E-15	1000
08141600000F	E-16	1000
08141700000F	E-17	1000

CÓDIGO	MEDIDA	ENVASE
08141800000F	E-18	1000
08141900000F	E-19	1000
08142000000F	E-20	1000
08142100000F	E-21	1000
08142200000F	E-22	500
08142300000F	E-23	500
08142400000F	E-24	500
08142500000F	E-25	500
08142600000F	E-26	500
08142800000F	E-28	250
08142900000F	E-29	250
08143000000F	E-30	250

Medidas en mm.



## 0815 ARANDELA NEOPRENO

Medida	P14	P16	P19	P25
d	5	6	7	7
D	14	16	19	25

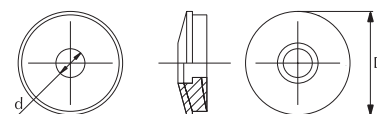

- Arandela EPDM para garantizar la estanquidad de la unión.

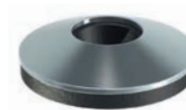

CÓDIGO	MEDIDA	ENVASE
08151400000Z	P14	1000
08151600000Z	P16	1000

CÓDIGO	MEDIDA	ENVASE
08151900000Z	P19	1000
08152500000Z	P25	500

## 0816 ARANDELA CASCABEL

d	9
D	18
s	0,7

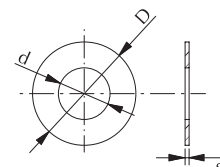

- Arandela plana para el tornillo cascabel.



CÓDIGO	(d)	ENVASE
08160900000B	9	200

## 0817 ARANDELA CAMA

d	9,5
D	31
s	1,5

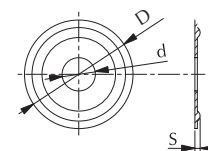

- Arandela nervada para el tornillo cama.



CÓDIGO	(d)	ENVASE
08170950000B	9,5	200

### 0818 DIN 125 LATÓN BISELADA

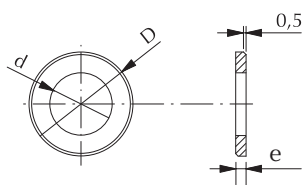

Medida	M4	M5	M6	M8	M10
d	4,3	5,3	6,4	8,4	10,5
D	8	10	11	15	18
e	0,8	1	1,1	1,2	1,6



- Arandela plana con bisel.
- Cuerpo de latón.

CÓDIGO	MEDIDA	ENVASE
08180400000T	M4	1000
08180500000T	M5	1000
08180600000T	M6	1000

CÓDIGO	MEDIDA	ENVASE
08180800000T	M8	500
08181000000T	M10	500

### 0819 DIN 9021 LATÓN

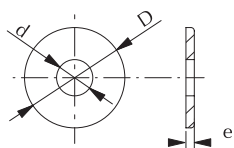

Medida	M4
d	4,3
D	12
e	1

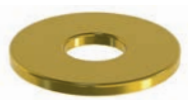

- Arandela plana de ala ancha.
- Cuerpo de latón.

CÓDIGO	(d)	ENVASE
08190400000T	M4	1000

A photograph of a server rack with multiple rows of blue metal frames. Numerous orange cables are bundled and routed through the frames, creating a complex network of lines. The lighting is somewhat dim, highlighting the textures of the metal and the vibrant color of the cables.

**TACOS, ANCLAJES Y  
BRIDAS DE NYLON**

**09**

0931 TACO PLÁSTICO NYLON CAJITA



- Taco plástico para fijación en hormigón, ladrillo hueco, ladrillo macizo.

CÓDIGO	MEDIDA	ENVASE
093104000203	4 X 20	200
093105000253	5 X 25	200
093106000303	6 X 30	200
093107000303	7 X 30	100

CÓDIGO	MEDIDA	ENVASE
093108000403	8 X 40	100
093110000503	10 X 50	100
093112000603	12 X 60	25
093114000753	14 X 75	25

0901 TACO PLÁSTICO NYLON GRANEL



- Taco plástico para fijación en hormigón, ladrillo hueco, ladrillo macizo.

CÓDIGO	MEDIDA	ENVASE
090104000203	4 X 20	1000
090105000253	5 X 25	1000
090106000303	6 X 30	1000
090107000303	7 X 30	1000

CÓDIGO	MEDIDA	ENVASE
090108000403	8 X 40	500
090110000503	10 X 50	250
090112000603	12 X 60	250
090114000753	14 X 75	250

0932 TACO PLUS MAT CAJITA

MEJOR RELACIÓN CALIDAD-PRECIO



- Taco de poliamida multimaterial para bloque, hormigón, ladrillo hueco, ladrillo macizo, pladur.

CÓDIGO	MEDIDA	ENVASE
093205000253	5 X 25	200
093206000303	6 X 30	200
093208000403	8 X 40	100

CÓDIGO	MEDIDA	ENVASE
093210000503	10 X 50	50
093212000603	12 X 60	25
093214000703	14 X 70	20

Medidas en mm.

0913 TACO PLUS MAT GRANEL



MEJOR RELACIÓN CALIDAD-PRECIO

- Taco de poliamida multimaterial para bloque, hormigón, ladrillo hueco, ladrillo macizo, pladur.



CÓDIGO	MEDIDA	ENVASE
091305000253	5 X 25	1000
091306000303	6 X 30	1000
091308000403	8 X 40	500

CÓDIGO	MEDIDA	ENVASE
091310000503	10 X 50	250
091312000603	12 X 60	250
091314000703	14 X 70	250

0936 TACO FACHADA CAJITA



- Taco de nylon para hormigón, ladrillo hueco y ladrillo macizo.



CÓDIGO	MEDIDA	ENVASE
093608000803	8 X 80	50
093608001003	8 X 100	50
093608001203	8 X 120	50
093610001003	10 X 100	50

CÓDIGO	MEDIDA	ENVASE
093610001153	10 X 115	50
093610001353	10 X 135	50
093610001603	10 X 160	50
093614001003	14 X 100	50

0935 TACO FACHADA GRANEL



- Taco de nylon para hormigón, ladrillo hueco y ladrillo macizo.



CÓDIGO	MEDIDA	ENVASE
093508000803	8 X 80	500
093508001003	8 X 100	500
093508001203	8 X 120	500
093510001003	10 X 100	250

CÓDIGO	MEDIDA	ENVASE
093510001153	10 X 115	250
093510001353	10 X 135	250
093510001603	10 X 160	250

0902 TACO PLÁSTICO BLANCO GRANEL



- Taco de mampostería de polietileno para fijación en hormigón, ladrillo hueco, ladrillo macizo.

CÓDIGO	MEDIDA	ENVASE
090205000201	5 X 20	1000
090206000221	6 X 22	1000
090207000231	7 X 23	1000

CÓDIGO	MEDIDA	ENVASE
090208000251	8 X 25	500
090210000401	10 X 40	250
090212000501	12 X 50	250

0914 TORNILLO TACO POZI

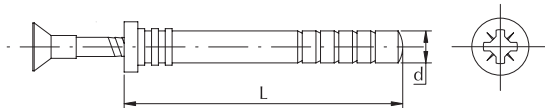

- Taco clavable de nylon + tornillo para hormigón, ladrillo hueco, ladrillo macizo, madera.
- Soporta hasta 150kg de carga.
- Tornillo con rosca arpón.

CÓDIGO	MEDIDA	ENVASE
09140500030Z	5 X 30	200
09140500040Z	5 X 40	200
09140500050Z	5 X 50	200
09140600030Z	6 X 30	200
09140600040Z	6 X 40	200
09140600050Z	6 X 50	200
09140600060Z	6 X 60	200

CÓDIGO	MEDIDA	ENVASE
09140600070Z	6 X 70	100
09140800060Z	8 X 60	100
09140800080Z	8 X 80	100
09140800100Z	8 X 100	100
09140800120Z	8 X 120	100
09140800140Z	8 X 140	100

Consultar disponibilidad en otras medidas.

0907 TACO PLÁSTICO UNIVERSAL CON ARANDELA

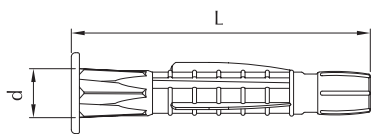

Medida ( d )	6 X 36	8 X 51	10 X 60
carga máxima hormigón 250 (kg/cm <sup>2</sup> )	20	35	55
Carga máxima ladrillo macizo(kg/cm <sup>2</sup> )	14	30	40
Carga máxima ladrillo hueco (kg/cm <sup>2</sup> )	10	20	25



CÓDIGO	MEDIDA	ENVASE
090706000361	6 X 36	1000
090708000511	8 X 51	1000

CÓDIGO	MEDIDA	ENVASE
090710000601	10 X 60	1000

Medidas en mm.

0940 TACO + TORNILLO AVELLANADO STAR



Medida	8 X 80	8 X 100	8 X 120	8 x 140	10 X 80	10 X 100	10 X 120	10 X 140	10 X 160	10 X 200	10 X 230
Ø broca	8	8	8	8	10	10	10	10	10	10	10
Espesor máx. a fijar	10	30	50	70	10	30	50	70	90	130	160
Medida tornillo	6 x 85	6 x 105	6 x 125	6 x 145	7 x 85	7 x 105	7 x 125	7 x 145	7 x 175	7 x 205	7 x 235
Star	T30	T30	T30	T30	T40	T40	T40	T40	T40	T40	T40

- Taco expansible de nylon + tornillo avellanado con huella star. Aplicaciones en piedra, hormigón, ladrillo hueco, ladrillo macizo, madera.



CÓDIGO	MEDIDA	ENVASE
09400800080Z	8 X 80	100
09400800100Z	8 X 100	100
09400800120Z	8 X 120	100
09400800140Z	8 X 140	50
09401000080Z	10 X 80	50
09401000100Z	10 X 100	50

CÓDIGO	MEDIDA	ENVASE
09401000120Z	10 X 120	50
09401000140Z	10 X 140	50
09401000160Z	10 X 160	50
09401000200Z	10 X 200	50
09401000230Z	10 X 230	25

0941 TACO + TORNILLO HEXAGONAL



Medida	8 X 80	8 X 100	8 X 120	8 x 140	10 X 80	10 X 100	10 X 120	10 X 140	10 X 160	10 X 200	10 X 230
Ø broca	8	8	8	8	10	10	10	10	10	10	10
Espesor máx. a fijar	10	30	50	70	10	30	50	70	90	130	160
Medida tornillo	6 x 85	6 x 105	6 x 125	6 x 145	7 x 85	7 x 105	7 x 125	7 x 145	7 x 175	7 x 205	7 x 235
Star	T30	T30	T30	T30	T40	T40	T40	T40	T40	T40	T40

- Taco expansible de nylon + tornillo hexagonal con huella star. Aplicaciones en piedra, hormigón, ladrillo hueco, ladrillo macizo, madera.



CÓDIGO	MEDIDA	ENVASE
09410800080Z	8 X 80	100
09410800100Z	8 X 100	100
09410800120Z	8 X 120	100
09410800140Z	8 X 140	50
09411000080Z	10 X 80	50
09411000100Z	10 X 100	50

CÓDIGO	MEDIDA	ENVASE
09411000120Z	10 X 120	50
09411000140Z	10 X 140	25
09411000160Z	10 X 160	25
09411000200Z	10 X 200	25
09411000230Z	10 X 230	25

0934 TACO SX PLUS CAJITA



Medida	4 X 20	5 X 25	6 X 30	8 X 40	10 X 50	12 X 60	14 X 70
Ø broca	4	5	6	8	10	12	14
Profundidad mín. taladro	25	35	40	50	70	80	90
Profundidad mín. a fijar	20	25	30	40	50	60	70
Ø tornillo	2 - 3	3 - 4	4 - 5	4,5 - 6	6 - 8	8 - 10	10 - 12

- Taco de nylon con cuatro lados de expansión.

CÓDIGO	MEDIDA	ENVASE
093404000203	4X20	200
093405000253	5X25	100
093406000303	6X30	100
093408000403	8X40	100

CÓDIGO	MEDIDA	ENVASE
093410000503	10X50	50
093412000603	12X60	25
093414000703	14X70	20



Medidas en mm.

### 0903 TACO SX PLUS GRANEL



Medida	6 X 30	8 X 40	10 X 50
Ø broca	6	8	10
Profundidad mín. taladro	40	50	70
Profundidad mín. a fijar	30	40	50
Ø tornillo	4 - 5	4,5 - 6	6 - 8

- Taco de nylon con cuatro lados de expansión.

CÓDIGO	MEDIDA	ENVASE
090306000303	6X30	3200
090308000403	8X40	1200

CÓDIGO	MEDIDA	ENVASE
090310000503	10X50	720

### 0904 TACO SXL PLUS



Medida	6 X 50 L	8 X 65 L	10 X 80 L
Ø broca	6	8	10
Profundidad mín. taladro	60	75	90
Profundidad mín. a fijar	50	65	80
Ø tornillo	4 - 5	4,5 - 6	6 - 8

- Taco de nylon largo con cuatro lados de expansión.

CÓDIGO	MEDIDA	ENVASE
090406000503	6X50	100
090408000653	8X65	50

CÓDIGO	MEDIDA	ENVASE
090410000803	10X80	25

### 0905 TACO UNIVERSAL UX



Medida	5 X 30	6 X 35	6 X 50	8 X 50	10 X 60	12 X 70	14 X 75
Ø broca	5	6	6	8	10	12	14
Profundidad mín. taladro	40	45	60	60	75	85	95
Profundidad mín. a fijar	9,5	9,5	9,5	9,5	12,5		
Ø tornillo	3 - 4	4 - 5	4 - 5	4,5 - 6	6 - 8	8 - 10	10 - 12

- Taco nylon universal para todo tipo de materiales.

CÓDIGO	MEDIDA	ENVASE
090505000303	5X30	100
090506000353	6X35	100
090506000503	6X50	100
090508000503	8X50	100

CÓDIGO	MEDIDA	ENVASE
090510000603	10X60	50
090512000703	12X70	25
090514000753	14X75	100

Medidas en mm.



0906 TACO UNIVERSAL UX-R



Medida	5 X 30 R	6 X 35 R	6 X 50 R	8 X 50 R	10 X 60 R
Ø broca	5	6	6	8	10
Profundidad mín. taladro	40	45	60	60	75
Profundidad mín. a fijar	9,5	9,5	9,5	9,5	12,5
Ø tornillo	3 - 4	4 - 5	4 - 5	4,5 - 6	6 - 8

- Taco nylon universal con reborde para todo tipo de materiales.

CÓDIGO	MEDIDA	ENVASE
090605000303	5 X 30	100
090606000353	6 X 35	100
090606000503	6 X 50	100

CÓDIGO	MEDIDA	ENVASE
090608000503	8 X 50	100
090610000603	10 X 60	50

0948 TACO DÚO POWER



Medida (d)	5 x 25	6 x 30	6 x 50	8 x 40	8 x 65
diámetro tornillo	3 - 4	4 - 5	4 - 5	4,5 - 6	4,5 - 6
min. profundidad agujero.h1	35	40	60	50	75
d <sub>0</sub> diámetro taladro	5	6	6	8	8
Espesor del panel dp	12,5	12,5	12,5	12,5	2 x 12,5

Medida (d)	10 x 50	10 x 80	12 x 60	14 x 70
diámetro tornillo	6 - 8	6 - 8	8 - 10	10 - 12
min. profundidad agujero.h1	70	100	80	90
d <sub>0</sub> diámetro taladro	10	10	12	14
Espesor del panel dp	12,5	-	-	-

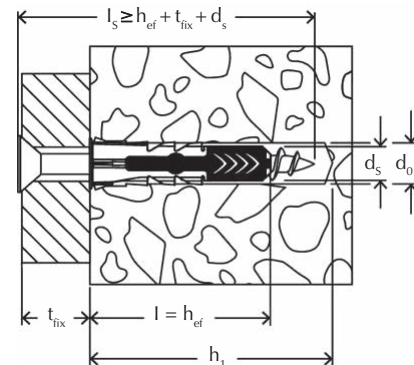

- Dos componentes de materiales para los mejores niveles de carga y funciones inteligentes dependiendo de la superficie.
- Apropiados para fijaciones en materiales perforados, hormigón poroso y para puenteados de revoque.



CÓDIGO	MEDIDA	ENVASE
094805000251	5 X 25	100
094806000301	6 X 30	100
094806000501	6 X 50	100
094808000401	8 X 40	100
094808000651	8 X 65	50

CÓDIGO	MEDIDA	ENVASE
094810000501	10 X 50	50
094810000801	10 X 80	25
094812000601	12 X 60	25
094814000701	14 X 70	20

Medidas en mm.

# ANCLAJES

## DESCUBRE NUESTRO NUEVO ANCLAJE CERTIFICADO



### 0926 ANCLAJE METÁLICO

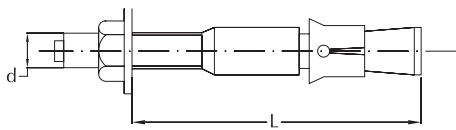

Medida	6x45	6x60	6x80	8x60	8x60	8x75	8x90
Profundidad mín. taladro	40	55	55	40	50	65	65
Ø broca	6	6	6	8	8	8	8
Par de apriete (Nm)	8	8	8	20	20	20	20
Espesor mín. material base	100	100	100	100	100	100	100
Distancia mín. entre ejes	120	120	120	150	150	150	150

Medida	8x115	8x130	10x70	10x90	10x120	10x150
Profundidad mín. taladro	65	65	60	90	75	75
Ø broca	8	8	10	10	10	10
Par de apriete (Nm)	20	20	40	40	40	40
Espesor mín. material base	100	100	110	110	110	110
Distancia mín. entre ejes	150	150	170	170	170	170

Medida	12x90	12x110	12x160	12x180	14x145	16x145
Profundidad mín. taladro	70	85	85	85	100	110
Ø broca	12	12	12	12	14	16
Par de apriete (Nm)	70	70	70	70	100	140
Espesor mín. material base	130	130	130	130	150	170
Distancia mín. entre ejes	200	200	200	200	230	260

- Anclaje metálico con rosca externa para cargas medias y altas.
- Para hormigón fisurado y no fisurado.

CÓDIGO	MEDIDA	ENVASE
09260600045Z	M6 X 45	200
09260600060Z	M6 X 60	200
09260600080Z	M6 X 80	200
09260800050Z	M8 X 50	100
09260800060Z	M8 X 60	100
09260800075Z	M8 X 75	100
09260800090Z	M8 X 90	100
09260800115Z	M8 X 115	100
09260800130Z	M8 X 130	100
09261000070Z	M10 X 70	100

CÓDIGO	MEDIDA	ENVASE
09261000090Z	M10 X 90	100
09261000120Z	M10 X 120	50
09261000150Z	M10 X 150	50
09261200090Z	M12 X 90	50
09261200110Z	M12 X 110	50
09261200160Z	M12 X 160	50
09261200180Z	M12 X 180	50
09261400145Z	M14 X 145	25
09261600145Z	M16 X 145	25

Medidas en mm.

0950 ANCLAJE METÁLICO LINEA AZUL



Medida	8x50	8x75	8x115	10x90	12x180	16x145
Profundidad mín. taladro	40	65	65	90	85	110
Ø broca	8	8	8	10	12	16
Par de apriete (Nm)	20	20	20	40	70	140
Espesor mín. material base	100	100	100	110	130	170
Distancia mín. entre ejes	150	150	150	170	200	260



- Anclaje metálico con rosca externa para cargas medias y altas.
- Homologado ETA/marcado CE.
- Línea azul como referencia para la instalación.
- Para hormigón fisurado y no fisurado.

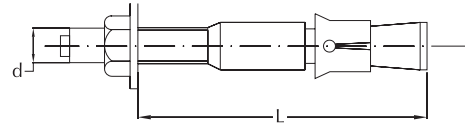

CÓDIGO	MEDIDA	ENVASE
09500800050Z	M8 X 50	100
09500800075Z	M8 X 75	100
09500800115Z	M8 X 115	100

CÓDIGO	MEDIDA	ENVASE
09501000090Z	M10 X 90	100
09501200180Z	M12 X 180	50
09501600145Z	M16 X 145	25

2926 ANCLAJE METÁLICO ACERO INOXIDABLE



Medida	6x45	6x60	6x80	8x50	8x90	8x115
Profundidad mín. taladro	40	55	55	40	65	65
Ø broca	6	6	6	8	8	8
Par de apriete (Nm)	8	8	8	20	20	20
Espesor mín. material base	100	100	100	100	100	100
Distancia mín. entre ejes	120	120	120	150	150	150

Medida	10x70	10x150	12x90	12x140	16x145
Profundidad mín. taladro	60	75	70	85	110
Ø broca	10	10	12	12	16
Par de apriete (Nm)	40	40	70	70	140
Espesor mín. material base	110	110	130	130	170
Distancia mín. entre ejes	170	170	200	200	260

- Anclaje metálico con rosca externa para cargas medias y altas.
- Acero inoxidable.
- Para hormigón fisurado y no fisurado.

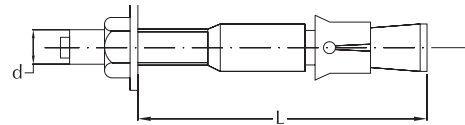

CÓDIGO	MEDIDA	ENVASE
29260600045A2	M6 X 45	200
29260600060A2	M6 X 60	200
29260600080A2	M6 X 80	200
29260800050A2	M8 X 50	100
29260800090A2	M8 X 90	100
29260800115A2	M8 X 115	100

CÓDIGO	MEDIDA	ENVASE
29261000070A2	M10 X 70	100
29261000150A2	M10 X 150	50
29261200090A2	M12 X 90	50
29261200140A2	M12 X 140	50
29261600145A2	M16 X 145	25

Medidas en mm.

0922 ANCLAJE EXPANSIÓN

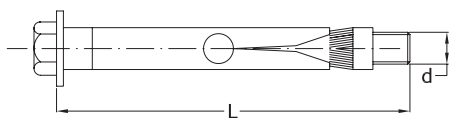

MEDIDA (dx)	M6 X 45-8	M6 X 45-9	M6 X 60-8	M6 X 60-9	M8 X 60-10	M8 X 60-11	M8 X 80-10
Profundidad taladro	45	45	60	60	60	60	80
Ø Agujero	8	9	8	9	10	11	10
Espesor máximo a fijar	5	5	15	15	5	5	15
Par de apriete (Nm)	10	10	10	10	20	20	20
Espesor mín. material base	100	100	100	100	100	100	105
Distancia mín. entre ejes	90	90	110	110	120	120	160

MEDIDA (dx)	M8 X 80-11	M10 X 70-12	M10 X 70-14	M10 X 100-12	M10 X 100-14	M12 X 80-16	M16 X 110-20
Profundidad taladro	80	70	70	100	100	80	110
Ø Agujero	11	12	14	12	14	16	20
Espesor máximo a fijar	15	5	5	25	25	5	25
Par de apriete (Nm)	20	35	35	35	35	50	80
Espesor mín. material base	105	100	100	110	110	110	145
Distancia mín. entre ejes	160	150	150	170	170	170	220



- Anclaje de camisa con tornillo para cargas medias y altas.

CÓDIGO	MEDIDA	ENVASE
09220604508Z	M6 X 45-8	200
09220604509Z	M6 X 45-9	250
09220606008Z	M6 X 60-8	200
09220606009Z	M6 X 60-9	200
09220806010Z	M8 X 60-10	100
09220806011Z	M8 X 60-11	150
09220808010Z	M8 X 80-10	100

CÓDIGO	MEDIDA	ENVASE
09220808011Z	M8 X 80-11	100
09221007012Z	M10 X 70-12	100
09221007014Z	M10 X 70-14	100
09221010012Z	M10 X 100-12	50
09221010014Z	M10 X 100-14	50
09221208016Z	M12 X 80-16	50
09221611020Z	M16 X 110-20	25

0924 ANCLAJE EXPANSIÓN ARGOLLA

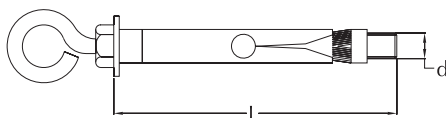

Medida	6X45-8	8X60-10	M10 X 70-12	M12 X 80-16
Profundidad taladro	45	60	70	80
Ø Agujero	8	10	12	16
Espesor máximo a fijar	5	15	5	5
Par de apriete (Nm)	10	20	35	35
Espesor mín. material base	100	100	100	110
Distancia mín. entre ejes	90	120	150	170



- Anclaje de camisa con anilla para cargas medias y altas.

CÓDIGO	MEDIDA	ENVASE
09240604508Z	M6 X 45-8	150
09240806010Z	M8 X 60-10	100

CÓDIGO	MEDIDA	ENVASE
09241007012Z	M10 X 70-12	50
09241208016Z	M12 X 80-16	25

Medidas en mm.

0925 ANCLAJE EXPANSIÓN GANCHO



Medida	6X45-8	8X60-10	M10 X 70-12	M12 X 80-16
Profundidad taladro	45	60	70	80
Ø Agujero	8	10	12	16
Espesor máximo a fijar	5	15	5	5
Par de apriete (Nm)	10	20	35	35
Espesor mín. material base	100	100	100	110
Distancia mín. entre ejes	90	120	150	170

- Anclaje de camisa con gancho para cargas medias y altas.

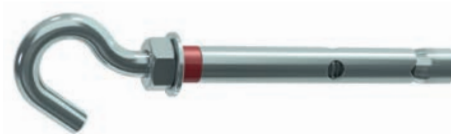
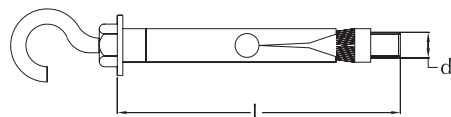

CÓDIGO	MEDIDA	ENVASE
09250604508Z	M6 X 45-8	100
09250806010Z	M8 X 60-10	100

CÓDIGO	MEDIDA	ENVASE
09251007012Z	M10 X 70-12	50
09251208016Z	M12 X 80-16	25

0952 ANCLAJE EXPANSIÓN GANCHO ESPIRAL



Medida	8X60-10	M10 X 70-12
Profundidad taladro	60	70
Ø Agujero	10	12
Espesor máximo a fijar	15	5
Par de apriete (Nm)	20	35
Espesor mín. material base	100	100
Distancia mín. entre ejes	120	150

- Anclaje de camisa con gancho en espiral, para cargas medias y altas.

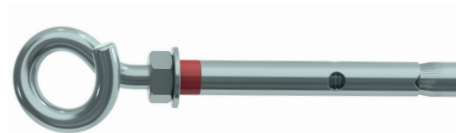
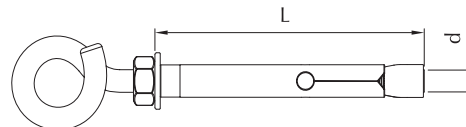

CÓDIGO	MEDIDA	ENVASE
09520806010Z	M8 X 60-10	100

CÓDIGO	MEDIDA	ENVASE
09521007012Z	M10 X 70-12	50

### 0927 ANCLAJE EXPANSIÓN HEMBRA



Medida (d)	M6	M8	M10	M12	M16	M20
Profundidad mín. taladro	25	30	40	50	65	80
Profundidad máx. taladro	26,7	32,3	42,9	53,5	69,6	85,8
L	25	30	40	50	65	80
Ø broca	8	10	12	15	20	25
Carga extracción	205	265	355	595	875	1190
Carga cizalladura	235	325	500	710	1295	2000



- Anclaje hembra con cono interior para medias cargas.

CÓDIGO	MEDIDA	ENVASE
09270600025Z	M6 X 25	100
09270800030Z	M8 X 30	100
09271000040Z	M10 X 40	100

CÓDIGO	MEDIDA	ENVASE
09271200050Z	M12 X 50	50
09271600065Z	M16 X 65	25
09272000080Z	M20 X 80	25

### 0951 ANCLAJE EXPANSIÓN HEMBRA MOLETEADO



Medida (d)	M6	M8	M10	M12	M16	M20
Profundidad mín. taladro	25	30	40	50	65	80
Profundidad máx. taladro	26,7	32,3	42,9	53,5	69,6	85,8
L	25	30	40	50	65	80
Ø broca	8	10	12	15	20	25
Carga extracción	205	265	355	595	875	1190
Carga cizalladura	235	325	500	710	1295	2000

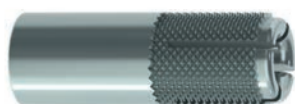

- Anclaje hembra con cono interior para medias cargas.
- Moleteado para mejorar el agarre.

CÓDIGO	MEDIDA	ENVASE
09510600025Z	M6 X 25	100
09510800030Z	M8 X 30	100
09511000040Z	M10 X 40	100

CÓDIGO	MEDIDA	ENVASE
09511200050Z	M12 X 50	50
09511600065Z	M16 X 65	25
09512000080Z	M20 X 80	25

### 0928 TACO RETACAR LATÓN

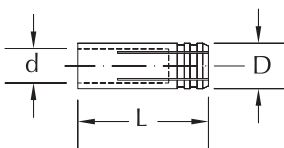

Medida (d)	M6	M8	M10
L	23	28	33
D	8	10	12



- Taco de expansión y rosca interior de latón.

CÓDIGO	MEDIDA	ENVASE
09280600023T	M6 X 23	100
09280800028T	M8 X 28	100

CÓDIGO	MEDIDA	ENVASE
09281000033T	M10 X 33	100

Medidas en mm.

# TORNILLERÍA PARA PLADUR

## 0908 TORNILLO PLADUR PASO FINO

d	3,5	3,9	4,2	4,8
D	8,4	8,4	8,5	9

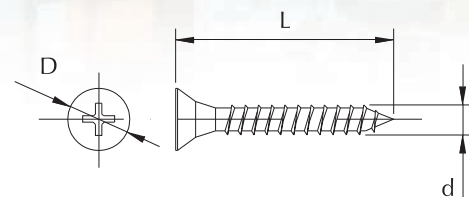

- Tornillo fosfatado para placas de cartón yeso.

CÓDIGO	MEDIDA	ENVASE
09080350025F	3,5 X 25	1000
09080350035F	3,5 X 35	1000
09080350045F	3,5 X 45	1000
09080350050F	3,5 X 50	500
09080350055F	3,5 X 55	500
09080390019F	3,9 X 19	1000
09080390038F	3,9 X 38	1000

CÓDIGO	MEDIDA	ENVASE
09080390050F	3,9 X 50	500
09080420070F	4,2 X 70	500
09080420080F	4,2 X 80	250
09080480090F	4,8 X 90	250
09080480100F	4,8 X 100	250
09080480110F	4,8 X 110	100
09080480120F	4,8 X 120	100

-  Incluye punta de atornillar en cada envasado.

## 0942 TORNILLO PLADUR PASO ANCHO

d	3,5
D	8,4

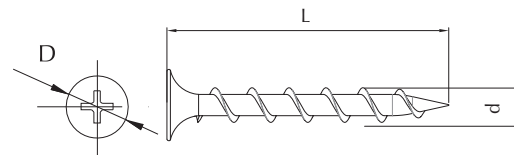

- Tornillo fosfatado paso ancho para placas de cartón yeso.

CÓDIGO	MEDIDA	ENVASE
09420350025F	3,5 X 25	1000
09420350035F	3,5 X 35	1000

CÓDIGO	MEDIDA	ENVASE
09420350045F	3,5 X 45	500
09420350055F	3,5 X 55	500

-  Incluye punta de atornillar en cada envasado.

Medidas en mm.  Puntas de atornillar disponibles en página 272.

## 0944 TORNILLO PLADUR AUTOTALADRANTE

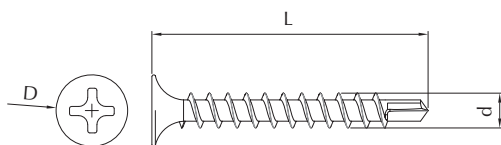

d	3,5
D	8,4



- Tornillo fosfatado con punta autotaladrante para placas de cartón yeso.

CÓDIGO	MEDIDA	ENVASE
09440350025F	3,5 X 25	1000
09440350035F	3,5 X 35	1000

CÓDIGO	MEDIDA	ENVASE
09440350045F	3,5 X 45	500
09440350055F	3,5 X 55	500

 Incluye punta de atornillar en cada envasado.

## 0915 TACO METÁLICO ARPÓN PLADUR

Medida	M4 X 32	M4 X 38	M4 X 46	M5 X 37	M5 X 52	M5 X 65	M6 X 37	M6 X 52	M6 X 65
L tornillo	38	45	52	45	58	71	45	58	71



- Anclaje en arpón para placas de cartón yeso, bloque, ladrillo hueco.

CÓDIGO	MEDIDA	ENVASE
09150400032Z	M4 X 32	100
09150400038Z	M4 X 38	100
09150400046Z	M4 X 46	100
09150500037Z	M5 X 37	100
09150500052Z	M5 X 52	100

CÓDIGO	MEDIDA	ENVASE
09150500065Z	M5 X 65	100
09150600037Z	M6 X 37	50
09150600052Z	M6 X 52	50
09150600065Z	M6 X 65	50



**0912 TACO NYLON PLADUR**

- Taco en poliamida para placas de cartón yeso. Apto para fijaciones ligeras.



CÓDIGO	ENVASE
091200000001	100

**0929 TACO PLADUR ZAMAK AUTOTALADRANTE**

- Taco para placas de cartón-yeso.



CÓDIGO	ENVASE
092900000000K	100

**0930 TACO PARAGUAS NYLON**

- Taco mariposa para placas de cartón-yeso en forma de arpón

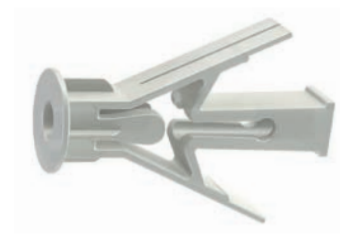

CÓDIGO	MEDIDA	ENVASE
093010000401	10 X 40	100
093010000471	10 X 47	100

## 0910 TACO METÁLICO AUTOPERFORANTE GKM

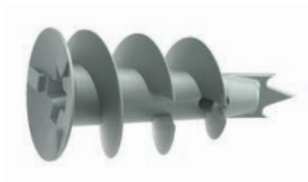

CÓDIGO	ENVASE
09100000000K	100

Tipo	GKM
Ø broca	8
Profundidad mín. esp. hueco	35
Espesor máx. a fijar	31

- Taco metálico autoperforante para paneles de pladur y fibras de yeso. No es necesaria la perforación en paneles de yeso, lo cual ahorra tiempo.
- Gran capacidad de carga gracias a la fijación de ajuste positivo.
- Se requiere menos espacio detrás del tablero debido a la corta longitud del anclaje.
- Perfecto para instalación en serie.
- Idea para el premontaje
- Adaptado a tornillos de madera, autoperforantes y de aglomerado de entre 4,0 y 5,0 mm de diámetro.
- Pretaladro con una broca de Ø 8 mm al utilizar tableros de fibra de yeso y paneles de yeso de doble tablero.
- No apto para tableros de yeso en losetas.

## 0911 TACO AUTOPERFORANTE GK

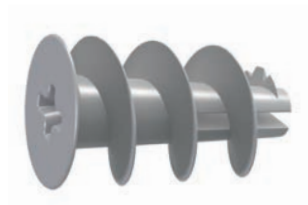

CÓDIGO	ENVASE
091100000003	100

Tipo	GK
Profundidad mín. esp. hueco	25
Espesor máx. a fijar	22

- Taco plástico autoperforante para paneles de pladur y fibras de yeso.
- Instalación simple y rápida gracias a la herramienta de montaje.
- Gran capacidad de carga gracias a la fijación de ajuste positivo.
- Se requiere menos espacio detrás del tablero debido a la corta longitud del anclaje.
- Perfecto para instalación en serie.
- Gracias a la ranura en cruz en la cabeza del taco, el GK se puede desmontar también sin herramienta de inserción como un tornillo.
- Adaptado a tornillos de madera, autoperforantes y de aglomerado de entre 4,0 y 5,0 mm de diámetro.
- Para grosores de tablero mayores de 15 mm, taladre primero un agujero utilizando la herramienta ajustadora.
- No apto para tableros de fibra de yeso y tableros de yeso en losetas.

Medidas en mm.

**0916 TACO BASCULANTE ESPÁRRAGO**

- Taco basculante para todo tipo de fijaciones en pladur, cubiertas, techos, planchas de fibra.



CÓDIGO	MEDIDA	ENVASE
09160400000Z	M4	50
09160500000Z	M5	50
09160600000Z	M6	50

**0917 TACO BASCULANTE GANCHO**

- Taco basculante con cáncamo abierto para todo tipo de fijaciones en pladur, cubiertas, techos, planchas de fibra.
- Apto para fijar lámparas y otros elementos colgantes.



CÓDIGO	MEDIDA	ENVASE
09170400000Z	M4	50
09170500000Z	M5	50
09170600000Z	M6	50

**0920 TACO BRIDA**

- Taco de nylon para fijar las abrazaderas de nylon.



CÓDIGO	MEDIDA	ENVASE
092006000002	6	100
092000000002	8	100

# ABRAZADERAS DE NYLON

Auténtica poliamida PA 6.6.

Uso en exteriores e interiores.

Inflamabilidad de la materia prima:  
UL 94 - V2.

Absorción de humedad:  
2,7% -2,8%

Temperatura de instalación:  
-10°C ~ + 85°C.

Temperatura de trabajo:  
-40°C ~ + 85°C.

Temperatura máxima para corto  
período: +110°C.

Buena resistencia a bases, aceites,  
grasas, derivados del petróleo,  
disolventes de cloruro.

Resistencia limitada a los ácidos.

No es resistente a los fenoles.

Mejor resistencia a los rayos UV  
gracias a los aditivos en abrazaderas  
negras.



**RoHS**

**REACH**



Alta resistencia  
a tracción

## 0921 ABRAZADERA NYLON



CÓDIGO	MEDIDA	ENVASE
092102400801	2,4 X 80	100
092102501001	2,5 X 100	100
092102501401	2,5 X 140	100
092102501601	2,5 X 160	100
092102502001	2,5 X 200	100
092103601401	3,6 X 140	100
092103602001	3,6 X 200	100
092103603001	3,6 X 300	100
092103603701	3,6 X 370	100
092104801201	4,8 X 120	100
092104801601	4,8 X 160	100
092104801801	4,8 X 180	100
092104802001	4,8 X 200	100

CÓDIGO	MEDIDA	ENVASE
092104802501	4,8 X 250	100
092104803001	4,8 X 300	100
092104803701	4,8 X 370	100
092104804301	4,8 X 430	100
092107601501	7,6 X 150	100
092107602001	7,6 X 200	100
092107603001	7,6 X 300	100
092107603701	7,6 X 370	100
092107604501	7,6 X 450	100
092107605401	7,6 X 540	100
092109007801	9 X 780	100
092112610401	12,6 X 1040	100



CÓDIGO	MEDIDA	ENVASE
092102400802	2,4 X 80	100
092102501002	2,5 X 100	100
092102501402	2,5 X 140	100
092102501602	2,5 X 160	100
092102502002	2,5 X 200	100
092103601402	3,6 X 140	100
092103602002	3,6 X 200	100
092103603002	3,6 X 300	100
092103603702	3,6 X 370	100
092104801202	4,8 X 120	100
092104801602	4,8 X 160	100
092104801802	4,8 X 180	100
092104802002	4,8 X 200	100

CÓDIGO	MEDIDA	ENVASE
092104802502	4,8 X 250	100
092104803002	4,8 X 300	100
092104803702	4,8 X 370	100
092104804302	4,8 X 430	100
092107601502	7,6 X 150	100
092107602002	7,6 X 200	100
092107603002	7,6 X 300	100
092107603702	7,6 X 370	100
092107604502	7,6 X 450	100
092107605402	7,6 X 540	100
092109007802	9 X 780	100
092112610402	12,6 X 1040	100

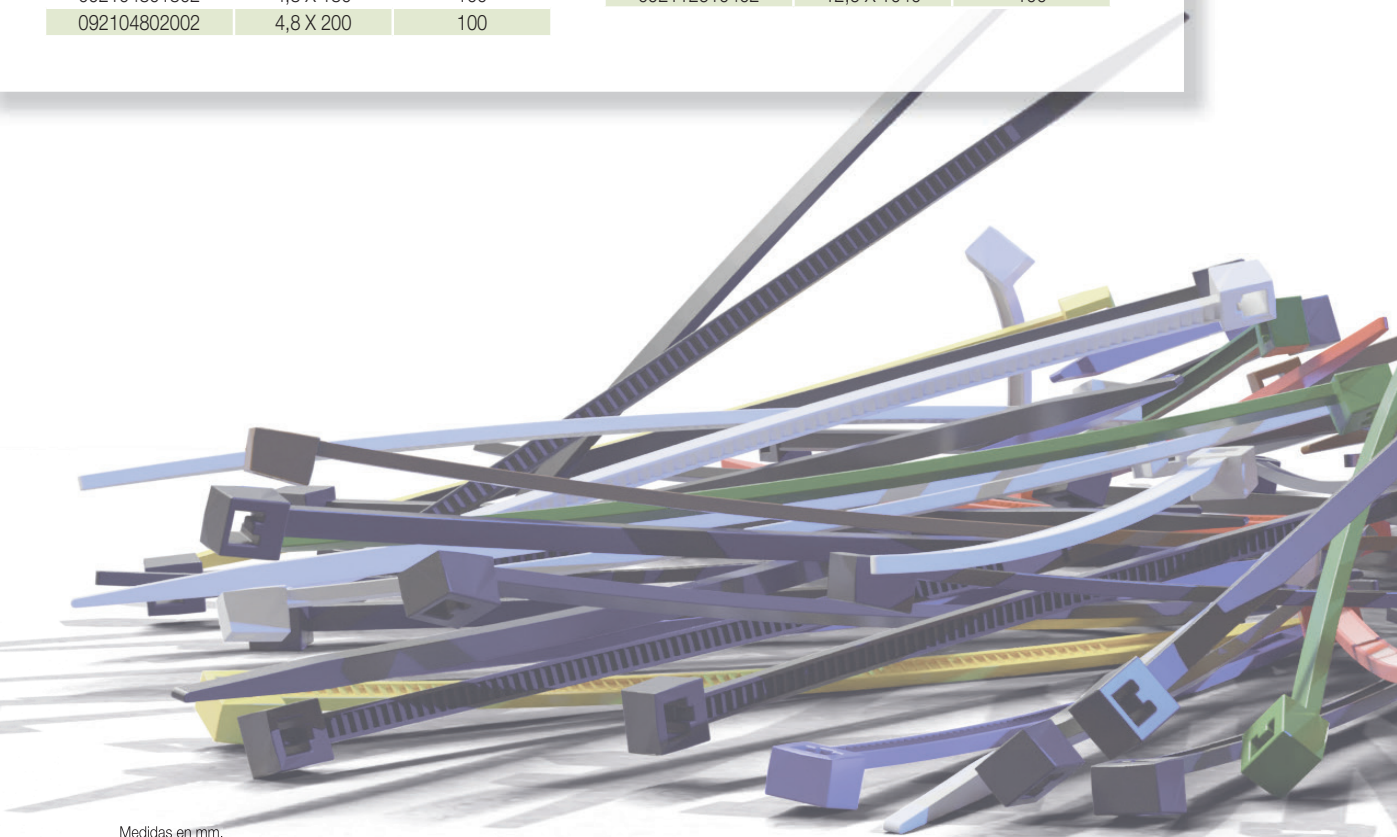

Medidas en mm.

0921 ABRAZADERA NYLON



CÓDIGO	MEDIDA	ENVASE
092102501004	2,5 X 100	100
092103601404	3,6 X 140	100
092103602004	3,6 X 200	100

CÓDIGO	MEDIDA	ENVASE
092104802004	4,8 X 200	100
092104803004	4,8 X 300	100



CÓDIGO	MEDIDA	ENVASE
092102501003	2,5 X 100	100
092103601403	3,6 X 140	100
092103602003	3,6 X 200	100

CÓDIGO	MEDIDA	ENVASE
092104802003	4,8 X 200	100
092104803003	4,8 X 300	100



CÓDIGO	MEDIDA	ENVASE
092102501005	2,5 X 100	100
092103601405	3,6 X 140	100
092103602005	3,6 X 200	100

CÓDIGO	MEDIDA	ENVASE
092104802005	4,8 X 200	100
092104803005	4,8 X 300	100



CÓDIGO	MEDIDA	ENVASE
092102501006	2,5 X 100	100
092103601406	3,6 X 140	100
092103602006	3,6 X 200	100

CÓDIGO	MEDIDA	ENVASE
092104802006	4,8 X 200	100
092104803006	4,8 X 300	100



CÓDIGO	MEDIDA	ENVASE
092102501007	2,5 X 100	100
092103601407	3,6 X 140	100
092103602007	3,6 X 200	100

CÓDIGO	MEDIDA	ENVASE
092104802007	4,8 X 200	100
092104803007	4,8 X 300	100

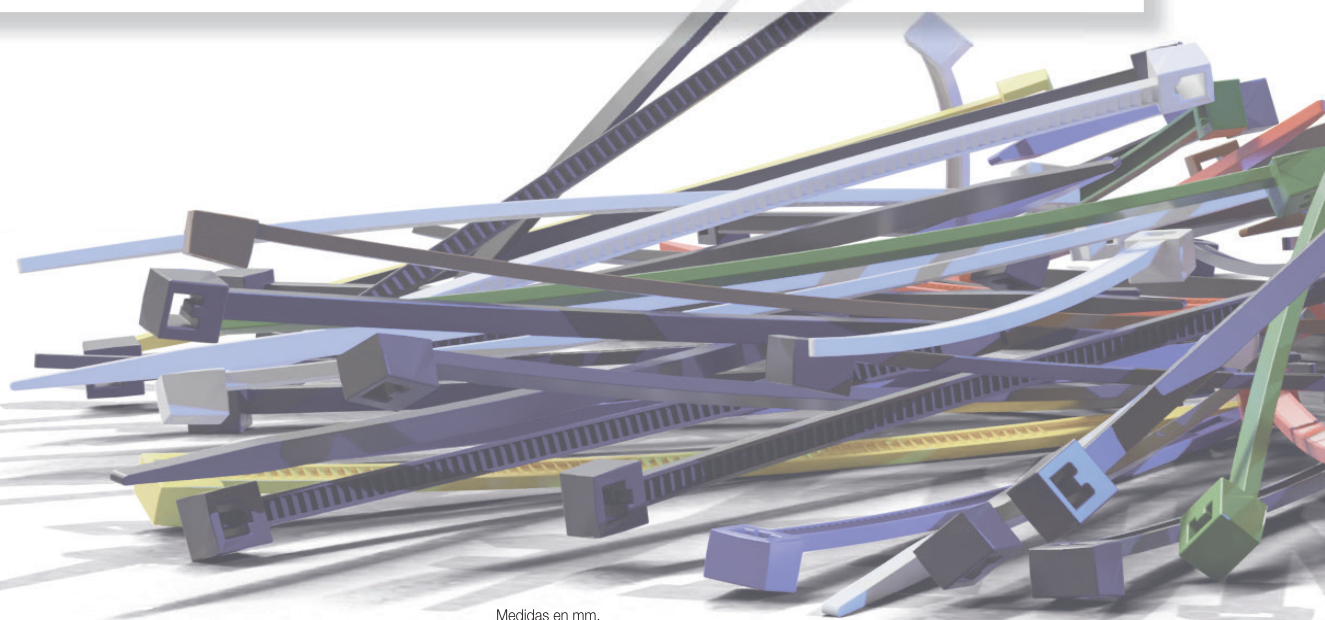

Medidas en mm.

A modern kitchen with wooden cabinets, a large window, and a dining table with chairs. The scene is brightly lit, likely by natural light from the window. The kitchen features a countertop with a sink and various items, and a dining table with chairs in the foreground. The overall aesthetic is clean and contemporary.

COMPLEMENTOS  
DE PLÁSTICO

10

## 1001 DESLIZANTE

- Deslizante de plástico con tacha metálica.



CÓDIGO	MEDIDA	ACABADO	ENVASE
10011500001	15	BLANCO	1000
10011500002	15	NEGRO	1000
10011500004	15	MARRÓN	1000
10011500005	15	ROBLE	1000
10011700001	17	BLANCO	1000

CÓDIGO	MEDIDA	ACABADO	ENVASE
10011700002	17	NEGRO	1000
10011700004	17	MARRÓN	1000
10011700005	17	ROBLE	1000
10011900004	19	MARRÓN	1000

## 1002 DESLIZANTE TIRAS

- Deslizante de plástico con tacha metálica en tiras.



CÓDIGO	MEDIDA	ACABADO	ENVASE
10021300001	13	BLANCO	1000



CÓDIGO	MEDIDA	ACABADO	ENVASE
10021300004	13	MARRÓN	1000

## 1003 SOPORTE GUITARRA

- Soporte plástico con tornillo roscado.



CÓDIGO	MEDIDA	ACABADO	ENVASE
100311000131	11 X 13	BLANCO	1000
100311000132	11 X 13	NEGRO	1000
100311000133	11 X 13	GRIS	1000
100311000134	11 X 13	MARRÓN	1000
100311000135	11 X 13	ROBLE	1000

CÓDIGO	MEDIDA	ACABADO	ENVASE
100315000201	15 X 20	BLANCO	500
100315000202	15 X 20	NEGRO	500
100315000204	15 X 20	MARRÓN	500
100315000205	15 X 20	ROBLE	500

Medidas en mm.



## 1004 SOPORTE GRAPIÑÓN

- Tope de plástico dos puntas metálicas.



CÓDIGO	MEDIDA	ACABADO	ENVASE
100407000201	7 X 20	BLANCO	1000
100407000202	7 X 20	NEGRO	1000
100407000204	7 X 20	MARRÓN	1000

CÓDIGO	MEDIDA	ACABADO	ENVASE
100411000201	11 X 20	BLANCO	1000
100411000204	11 X 20	MARRÓN	1000

## 1005 ZOLETA

- Deslizante quitarruido para grapa.



CÓDIGO	MEDIDA	ACABADO	ENVASE
100514000351	14 X 35	BLANCO	1000

CÓDIGO	MEDIDA	ACABADO	ENVASE
100514000354	14 X 35	MARRÓN	1000

## 1006 ZOLETA TIRAS

- Deslizante quitarruido para grapa.
- Aplicación con pistola neumática.



CÓDIGO	MEDIDA	ACABADO	ENVASE
100614000351	14 X 35	BLANCO	1000

CÓDIGO	MEDIDA	ACABADO	ENVASE
100614000354	14 X 35	MARRÓN	1000

## 1007 SOPORTE LEJA

- Soporte plástico sin tacha.



CÓDIGO	MEDIDA	ACABADO	ENVASE
100708000161	8 X 16	BLANCO	1000

CÓDIGO	MEDIDA	ACABADO	ENVASE
100708000164	8 X 16	MARRÓN	1000

## 1008 TAPA PLÁSTICO EXCÉNTRICA

- Tapa para excéntricas.



CÓDIGO	Ø EXCÉNTRICA	ACABADO	ENVASE
100815000001	15	BLANCO	1000
100815000002	15	NEGRO	1000
100815000004	15	MARRÓN	1000
100835000001	35	BLANCO	1000

CÓDIGO	Ø EXCÉNTRICA	ACABADO	ENVASE
100835000002	35	NEGRO	1000
100835000003	35	GRIS	1000
100835000004	35	MARRÓN	1000

Excéntricas disponibles en página 226.

## 1033 TAPA PLÁSTICO PRESIÓN EXCÉNTRICA

- Tapón para agujero de excéntricas.



CÓDIGO	Ø EXCÉNTRICA	ACABADO	ENVASE
103335000001	35	BLANCO	250

CÓDIGO	Ø EXCÉNTRICA	ACABADO	ENVASE
103335000004	35	MARRÓN	250

Excéntricas disponibles en página 226.

## 1009 MEDIA LUNA PLÁSTICO

- Media luna para ensamblaje de módulos.



CÓDIGO	Ø	ACABADO	ENVASE
100906500001	6,5 X 34	BLANCO	1000

## 1010 SOPORTE PLÁSTICO TUBO

- Soporte para tubo armario.



CÓDIGO	MEDIDA	ACABADO	ENVASE
101015000001	15	BLANCO	200

CÓDIGO	MEDIDA	ACABADO	ENVASE
101015000004	15	MARRÓN	200

## 1011 SOPORTE ENGANCHE

- Soporte ensamble.



CÓDIGO	MEDIDA	ACABADO	ENVASE
101113000001	13	BLANCO	500
101113000002	13	NEGRO	500

CÓDIGO	MEDIDA	ACABADO	ENVASE
101113000004	13	MARRÓN	200
101113000005	13	ROBLE	500

Tornillo enganche disponible en página 43.

## 1012 BOTE COLA

- Cola blanca.



CÓDIGO	MEDIDA	ACABADO	ENVASE
101215000001	15gr	BLANCO	500

### 1013 POMO PLÁSTICO



- Pomo plástico con tapa.

CÓDIGO	MEDIDA	ACABADO	ENVASE
101328000041	28 - M4	BLANCO	1000
101328000042	28 - M4	NEGRO	1000
101328000061	28 - M6	BLANCO	1000

CÓDIGO	MEDIDA	ACABADO	ENVASE
101328000062	28 - M6	NEGRO	1000
101349000082	49 - M8	NEGRO	500
101360000102	60 - M10	NEGRO	1000

### 1014 TUERCA EMBUTIR PLÁSTICO



- Tuerca embutir de plástico expansible.



CÓDIGO	MEDIDA	ACABADO	ENVASE
101406011101	M6 11 X 10	BLANCO	1000

CÓDIGO	MEDIDA	ACABADO	ENVASE
101406011124	M6 11 X 12	MARRÓN	1000

### 1015 TUERCA EMBUTIR PLÁSTICO TIRAS



- Tuerca embutir de plástico blanco en tiras.

CÓDIGO	MEDIDA	ACABADO	ENVASE
101506011101	M6 11 X 10	BLANCO	1000

### 1016 SOPORTE PLÁSTICO CASQUILLO

- Tapón casquillo de plástico en colores surtidos.



CÓDIGO	MEDIDA	ACABADO	ENVASE
101610000051	10 - Ø5	BLANCO	1000
101610000052	10 - Ø5	NEGRO	1000

CÓDIGO	MEDIDA	ACABADO	ENVASE
101610000054	10 - Ø5	MARRÓN	1000
101610000055	10 - Ø5	ROBLE	1000

### 1017 TAPÓN PLÁSTICO UNIÓN COCINA

- Tapón para tornillo de unión cocina.



CÓDIGO	MEDIDA	ACABADO	ENVASE
101711000001	11	BLANCO	1000
101711000004	11	MARRÓN	1000

CÓDIGO	MEDIDA	ACABADO	ENVASE
101711000005	11	ROBLE	1000

### 1018 TAPÓN PLÁSTICO POZI

- Tapón para tornillos con huella pozidrive.



CÓDIGO	+	ACABADO	ENVASE
101813000021	13 - PZ2	BLANCO	1000
101813000022	13 - PZ2	NEGRO	1000

CÓDIGO	+	ACABADO	ENVASE
101813000024	13 - PZ2	MARRÓN	1000
101813000025	13 - PZ2	ROBLE	1000

### 1019 TAPÓN PLÁSTICO ALLEN

- Tapón para tornillos con huella hexagonal allen.

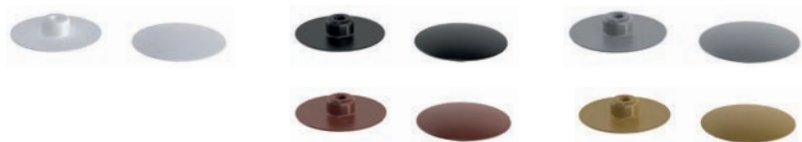

CÓDIGO	⊙	ACABADO	ENVASE
101913000041	13 - ALLEN 4	BLANCO	1000
101913000042	13 - ALLEN 4	NEGRO	1000
101913000043	13 - ALLEN 4	GRIS	1000

CÓDIGO	⊙	ACABADO	ENVASE
101913000044	13 - ALLEN 4	MARRÓN	1000
101913000045	13 - ALLEN 4	ROBLE	1000

Medidas en mm.

## 1020 TAPÓN PLÁSTICO AGUJERO

- Tapón plástico para agujeros de 8-10mm.



CÓDIGO	MEDIDA	ACABADO	ENVASE
102013000081	13 - Ø8	BLANCO	1000
102013000082	13 - Ø8	NEGRO	1000
102013000084	13 - Ø8	MARRÓN	1000
102013000085	13 - Ø8	ROBLE	1000

CÓDIGO	MEDIDA	ACABADO	ENVASE
102013000101	13 - Ø10	BLANCO	1000
102013000102	13 - Ø10	NEGRO	1000
102013000104	13 - Ø10	MARRÓN	1000
102013000105	13 - Ø10	ROBLE	1000

## 1021 TAPÓN PLÁSTICO PORTAESTANTE

- Tapón para agujeros de estantería.



CÓDIGO	Ø	ACABADO	ENVASE
102107000051	7 - Ø5	BLANCO	1000
102107000052	7 - Ø5	NEGRO	1000

CÓDIGO	Ø	ACABADO	ENVASE
102107000053	7 - Ø5	GRIS	1000
102107000055	7 - Ø5	ROBLE	1000

## 1022 TOPE ADHESIVO



- Gotas adhesivas de silicona transparente.
- "Quita ruidos".

CÓDIGO	MEDIDA	ACABADO	ENVASE
102207000010	7 X 1,5	TRANSPARENTE	1000
102210000010	10 X 1,5	TRANSPARENTE	1000

CÓDIGO	MEDIDA	ACABADO	ENVASE
102210000030	10 X 3	TRANSPARENTE	5000
102213000040	13 X 4	TRANSPARENTE	4000

Consultar cantidad mínima de servicio.

Medidas en mm.

1023 TAPATORNILLOS ADHESIVOS

• Láminas adhesivas para tapar tornillos, agujeros u otras imperfecciones en todo tipo de muebles y acabados.

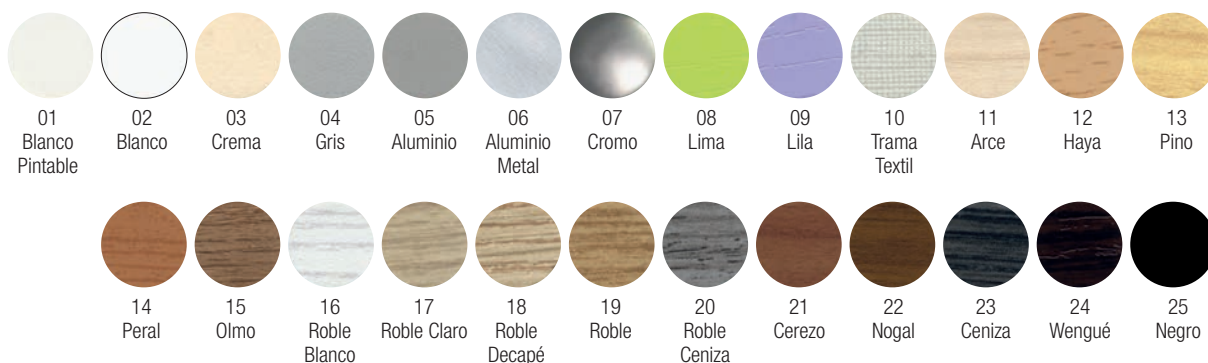

CÓDIGO	MEDIDA	ACABADO	ENVASE
102301300001	13	BLANCO PINTABLE	2000
102301300002	13	BLANCO	2000
102301300003	13	CREMA	2000
102301300004	13	GRIS	2000
102301300005	13	ALUMINIO	2000
102301300006	13	ALUMINIO METAL	2000
102301300007	13	CROMO	2000
102301300008	13	LIMA	2000
102301300009	13	LILA	2000
102301300010	13	TRAMA TEXTIL	2000
102301300011	13	ARCE	2000
102301300012	13	HAYA	2000
102301300013	13	PINO	2000
102301300014	13	PERAL	2000
102301300015	13	OLMO	2000
102301300016	13	ROBLE BLANCO	2000
102301300017	13	ROBLE CLARO	2000
102301300018	13	ROBLE DECAPÉ	2000
102301300019	13	ROBLE	2000
102301300020	13	ROBLE CENIZA	2000
102301300021	13	CEREZO	2000
102301300022	13	NOGAL	2000
102301300023	13	CENIZA	2000
102301300024	13	WENGUÉ	2000
102301300025	13	NEGRO	2000
102301600001	16	BLANCO PINTABLE	1000
102301600002	16	BLANCO	1000
102301600003	16	CREMA	1000
102301600004	16	GRIS	1000
102301600005	16	ALUMINIO	1000
102301600006	16	ALUMINIO METAL	1000
102301600007	16	CROMO	1000
102301600008	16	LIMA	1000
102301600009	16	LILA	1000
102301600010	16	TRAMA TEXTIL	1000
102301600011	16	ARCE	1000
102301600012	16	HAYA	1000
102301600014	16	PERAL	1000
102301600015	16	OLMO	1000
102301600016	16	ROBLE BLANCO	1000
102301600017	16	ROBLE CLARO	1000
102301600018	16	ROBLE DECAPÉ	1000
102301600019	16	ROBLE	1000
102301600020	16	ROBLE CENIZA	1000
102301600021	16	CEREZO	1000
102301600023	16	CENIZA	1000
102301600024	16	WENGUÉ	1000
102301600025	16	NEGRO	1000
102302500001	25	BLANCO PINTABLE	720

CÓDIGO	MEDIDA	ACABADO	ENVASE
102302500002	25	BLANCO	720
102302500003	25	CREMA	720
102302500004	25	GRIS	720
102302500005	25	ALUMINIO	720
102302500006	25	ALUMINIO METAL	720
102302500007	25	CROMO	720
102302500008	25	LIMA	720
102302500009	25	LILA	720
102302500010	25	TRAMA TEXTIL	720
102302500011	25	ARCE	720
102302500012	25	HAYA	720
102302500013	25	PINO	720
102302500014	25	PERAL	720
102302500015	25	OLMO	720
102302500016	25	ROBLE BLANCO	720
102302500017	25	ROBLE CLARO	720
102302500018	25	ROBLE DECAPÉ	720
102302500019	25	ROBLE	720
102302500020	25	ROBLE CENIZA	720
102302500021	25	CEREZO	720
102302500022	25	NOGAL	720
102302500023	25	CENIZA	720
102302500024	25	WENGUÉ	720
102302500025	25	NEGRO	720
102304000001	40	BLANCO PINTABLE	180
102304000002	40	BLANCO	180
102304000003	40	CREMA	180
102304000004	40	GRIS	180
102304000005	40	ALUMINIO	180
102304000006	40	ALUMINIO METAL	180
102304000007	40	CROMO	180
102304000008	40	LIMA	180
102304000009	40	LILA	180
102304000010	40	TRAMA TEXTIL	180
102304000011	40	ARCE	180
102304000012	40	HAYA	180
102304000013	40	PINO	180
102304000014	40	PERAL	180
102304000015	40	OLMO	180
102304000016	40	ROBLE BLANCO	180
102304000017	40	ROBLE CLARO	180
102304000018	40	ROBLE DECAPÉ	180
102304000019	40	ROBLE	180
102304000020	40	ROBLE CENIZA	180
102304000021	40	CEREZO	180
102304000022	40	NOGAL	180
102304000023	40	CENIZA	180
102304000024	40	WENGUÉ	180
102304000025	40	NEGRO	180

Consultar cantidad mínima de servicio.

Consultar disponibilidad en otros acabados o diámetros. Fabricación bajo muestra: consulte condiciones.

Medidas en mm.

### 1030 REGULADOR PATA

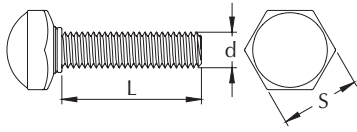

d	M8
S	18
L	30



- Tornillo regulador para muebles de cocina.

CÓDIGO	MEDIDA	ACABADO	ENVASE
10300800030Z	M8 X 30	CINCADO	200

### 1031 TORNILLO REGULADOR

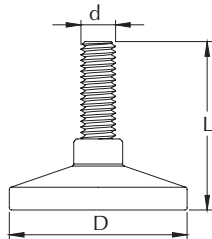

Medida	M8 X 36-30	M8 X 38-40	M10 X 47-40	M10 X 75-40
d	M8	M8	M10	M10
D	30	40	40	40
L	36	38	47	75



- Pata regulador de altura.

CÓDIGO	MEDIDA	ACABADO	ENVASE
10310803630Z	M8 X 36 Ø30	CINCADO	100
10310803840Z	M8 X 38 Ø40	CINCADO	100

CÓDIGO	MEDIDA	ACABADO	ENVASE
10311004740Z	M10 X 47 Ø40	CINCADO	100
10311007540Z	M10 X 75 Ø40	CINCADO	100

### 1032 CAPUCHÓN PLÁSTICO

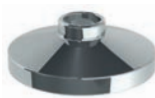

- Embellecedor para tornillo regulador.

CÓDIGO	MEDIDA	ACABADO	ENVASE
10323000002C	Ø30	CROMO BRILLO	100

CÓDIGO	MEDIDA	ACABADO	ENVASE
10324000002C	Ø40	CROMO BRILLO	100



CÓDIGO	MEDIDA	ACABADO	ENVASE
10323000001C	Ø30	CROMO MATE	100

CÓDIGO	MEDIDA	ACABADO	ENVASE
10324000001C	Ø40	CROMO MATE	100

Medidas en mm.





**COMPLEMENTOS  
METÁLICOS**

**11**

### 1101 EXCÉNTRICA Ø 15

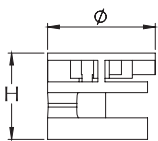

Medida	15 X 10	15 X 12
Ø	15	15
H	10	12



- Sistema para unión de módulos.
- Excéntrica de zamak inyectado.

CÓDIGO	MEDIDA	ACABADO	ENVASE
11011500010Z	Ø15 X 10	CINCADO	500

CÓDIGO	MEDIDA	ACABADO	ENVASE
11011500012Z	Ø15 X 12	CINCADO	500

Tapas de plástico disponibles en la página 218.

### 1101 EXCÉNTRICA Ø 25

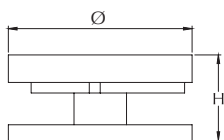

Medida	25
Ø	25
H	12



- Sistema para unión de módulos.
- Excéntrica de zamak inyectado.

CÓDIGO	MEDIDA	ACABADO	ENVASE
11012500012Z	Ø25 X 12,2	CINCADO	500

### 1101 EXCÉNTRICA Ø 35

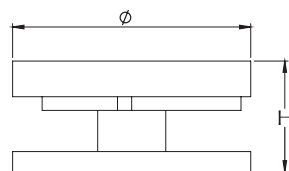

Medida	35
Ø	35
H	16



- Sistema para unión de módulos.
- Excéntrica de zamak inyectado.

CÓDIGO	MEDIDA	ACABADO	ENVASE
11013500016Z	Ø35 X 16,3	CINCADO	200

Tapas de plástico disponibles en la página 218.

Medidas en mm.

### 1102 PERNO ROSCA MÉTRICA EXCÉNTRICA Ø 15

Medida (M X D)	M6 X 32	M6 Ø7X32
Ø	6	7,3
L	7	6
Ø excéntrica	15	15

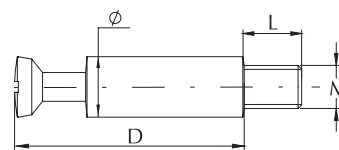

- Sistema para unión de módulos.
- Perno para unión entre la excéntrica y la tuerca.



CÓDIGO	MEDIDA	ACABADO	ENVASE
11020600032Z	M6 X 32 (Ø15)	CINCADO	500

### 1102 PERNO ROSCA MÉTRICA EXCÉNTRICA Ø 25

Medida (M X D)	M6 X 33
Ø	7
L	9
Ø excéntrica	25

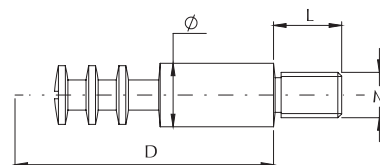

- Sistema para unión de módulos.
- Perno para unión entre la excéntrica y la tuerca.

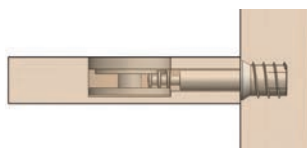

CÓDIGO	MEDIDA	ACABADO	ENVASE
11020600033Z	M6 X 33 (Ø25)	CINCADO	500

### 1102 PERNO ROSCA MÉTRICA EXCÉNTRICA Ø 35

Medida (M X D)	M6 X 35	M8 X 35	M8 X 55
Ø	8,5	8,5	8,5
L	9	11	11
Ø excéntrica	35	35	35

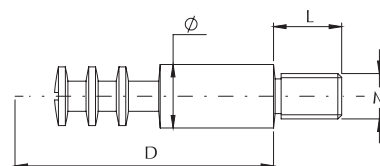

- Sistema para unión de módulos.
- Perno para unión entre la excéntrica y la tuerca.

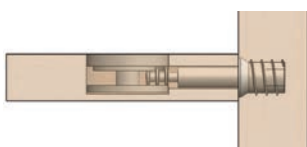

CÓDIGO	MEDIDA	ACABADO	ENVASE
11020600035Z	M6 X 35 (Ø35)	CINCADO	200
11020800035Z	M8 X 35 (Ø35)	CINCADO	200

CÓDIGO	MEDIDA	ACABADO	ENVASE
11020800055Z	M8 X 55 (Ø35)	CINCADO	200

Medidas en mm.

### 1103 PERNO ROSCA MADERA EXCÉNTRICA Ø 15

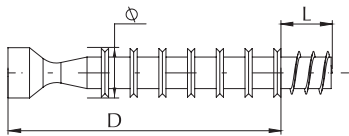

Medida (Ø X D)	7 X 35
L	9
Ø excéntrica	15

- Sistema para unión de módulos.
- Perno para unión entre la excéntrica y la madera.

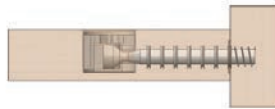

CÓDIGO	MEDIDA	ACABADO	ENVASE
11030700035Z	Ø7 X 35 (Ø15)	CINCADO	500

### 1106 TAPA EXCÉNTRICA ZAMAK Ø 25



- Tapa embellecedora para agujeros de excéntrica.

CÓDIGO	MEDIDA	ACABADO	ENVASE
11060250000Q	Ø25	NIQUELADO	500

### 1106 TAPA EXCÉNTRICA ZAMAK Ø 35



- Tapa embellecedora para agujeros de excéntrica.

CÓDIGO	MEDIDA	ACABADO	ENVASE
11060350000Q	Ø35	NIQUELADO	200

1107 GOLPETE NYLON

A	22
B	24
C	30

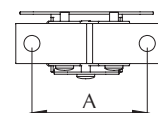
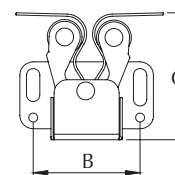

- Cierre quitarruidos para puertas.

CÓDIGO	MEDIDA	ACABADO	ENVASE
11070000000U	30 X 24	CUERO	100

1108 SOPORTE SAFETI

d	3	5
L	8	8
L2	17	17

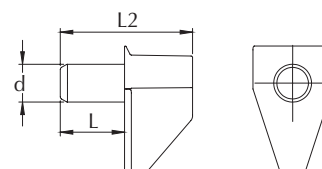

- Soporte portaestante transparente.

CÓDIGO	MEDIDA	ACABADO	ENVASE
110803000000	Ø3	TRANSPARENTE	500

CÓDIGO	MEDIDA	ACABADO	ENVASE
110805000000	Ø5	TRANSPARENTE	500

1160 SOPORTE ESTANTE ESCUADRA CON VENTOSA

d	5
L	8

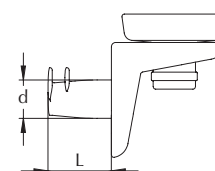

- Soporte portaestante con ventosa para cristal.

CÓDIGO	MEDIDA	ACABADO	ENVASE
11600500008Q	5 X 8	NIQUELADO	500

Medidas en mm.

### 1109 SOPORTE ESTANTE METÁLICO

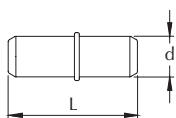

d	5
L	16



CÓDIGO	MEDIDA	ACABADO	ENVASE
11090500016B	5 X 16	BICROMATADO	1000

- Soporte portaestante de metal.



CÓDIGO	MEDIDA	ACABADO	ENVASE
11090500016Z	5 X 16	CINCADO	1000



CÓDIGO	MEDIDA	ACABADO	ENVASE
11090500016Q	5 X 16	NIQUELADO	1000



CÓDIGO	MEDIDA	ACABADO	ENVASE
11090500016U	5 X 16	CUERO	1000



CÓDIGO	MEDIDA	ACABADO	ENVASE
11090500016P	5 X 16	PAVONADO	1000

### 1110 SOPORTE VITRINA

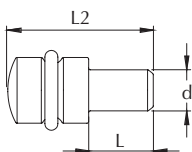

d	5
L	8
L2	18



CÓDIGO	MEDIDA	ACABADO	ENVASE
11100500018T	5 X 8 X 18	LATÓN	500

- Soporte portaestante con protector de goma para cristal.



CÓDIGO	MEDIDA	ACABADO	ENVASE
11100500020Q	5 X 7 X 20	NIQUELADO	500

Medidas en mm.

1113 PIVOTE CENTRADOR MESA

Medida	8 X 20	10 X 24
d	6	7
D	8	10
L1	10	12
L2	10	12

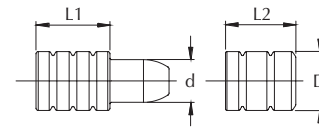

- Pivote centrador con casquillo para unión de tableros.
- Hembra pasante.



CÓDIGO	MEDIDA	ACABADO	ENVASE
11130800020Z	8 X 20	CINCADO	500

CÓDIGO	MEDIDA	ACABADO	ENVASE
11131000024Z	10 X 24	CINCADO	500

1114 EMBELLECEDOR

D	16	18
L	5	6

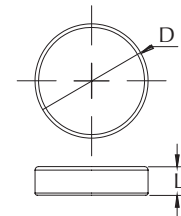

- Embellecedor para tornillos avellanados.



CÓDIGO	MEDIDA	ACABADO	ENVASE
11141600000Q	Ø16	NIQUELADO	100

CÓDIGO	MEDIDA	ACABADO	ENVASE
11141800000Q	Ø18	NIQUELADO	100

CÓDIGO	MEDIDA	ACABADO	ENVASE
11141600000T	Ø16	LATON	100

CÓDIGO	MEDIDA	ACABADO	ENVASE
11141800000T	Ø18	LATON	100



## 1115 OVALILLO LATONADO

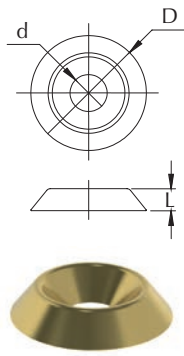

Medida	9	11	13	15
d	3,2	4,2	4	6,5
D	8,8	10,8	12,5	14
L	2,2	2	2,2	2,8

- Ovalillos en hierro latonado para embellecer y ocultar las cabezas de los tornillos.

CÓDIGO	MEDIDA	ACABADO	ENVASE
11150900000L	Ø9	LATONADO	1000
11151100000L	Ø11	LATONADO	1000

CÓDIGO	MEDIDA	ACABADO	ENVASE
11151300000L	Ø13	LATONADO	1000
11151500000L	Ø15	LATONADO	1000

Consultar cantidad mínima de servicio.

## 1117 GRAPA TRASERA REDONDA

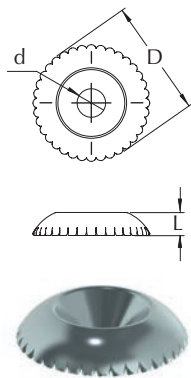

d	4,5
D	15
L	3

- Grapa para la unión de láminas traseras de los muebles.

CÓDIGO	MEDIDA	ACABADO	ENVASE
11171500000Z	Ø15	CINCADO	1000

## 1121 MEDIA LUNA

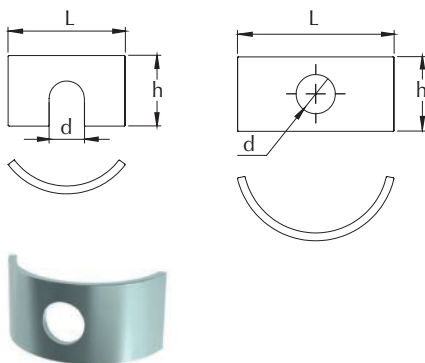

Medida (L)	30	40
d	9	10
h	18	19

- Media luna para ensamblaje de módulos.

CÓDIGO	MEDIDA	ACABADO	ENVASE
11210380019Z	3/8" X 40 X 19	CINCADO	200

CÓDIGO	MEDIDA	ACABADO	ENVASE
11210800018Z	M8 X 30 X 18	CINCADO	200

Medidas en mm.



1122 MEDIA LUNA ROSCADA ZAMAK

d	M8
h	16
L	34
A	14

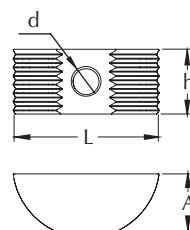

- Media luna para ensamblaje de módulos con rosca interior.

CÓDIGO	MEDIDA	ACABADO	ENVASE
11220800000K	M8	ZAMAK	200

Consultar disponibilidad en otras medidas.

1123 ESCUADRA CON PESTAÑA

Medida (L)	50	60	70
A	30	30	30

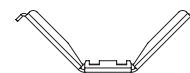
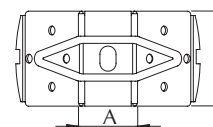

- Escuadra para ensamblaje mesas de madera.

CÓDIGO	MEDIDA	ACABADO	ENVASE
11230000050V	50	GALVANIZADO	100
11230000060V	60	GALVANIZADO	100

CÓDIGO	MEDIDA	ACABADO	ENVASE
11230000070V	70	GALVANIZADO	100

1124 CARTABÓN

TIPO	PLANO	ESPECIAL
L	130	130
h	65	57
e	0,5	15

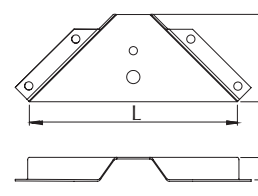
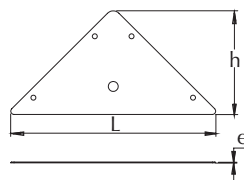

- Cartabón de refuerzo para colgar muebles.

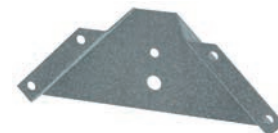

CÓDIGO	MEDIDA	ACABADO	ENVASE
11240000000V		GALVANIZADO	100

CÓDIGO	MEDIDA	ACABADO	ENVASE
11240000015V	15	GALVANIZADO	250

Medidas en mm.

1125 ESCUADRA FORMA "L"

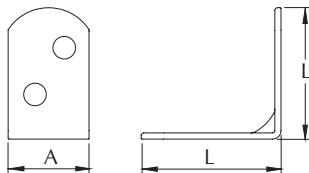

Medida (L X L)	20 X 20	30 X 30	40 X 40	50 X 50	60 X 60	70 X 70	80 X 80
A	18,5	18,5	18,5	18,5	18,5	18,5	18,5

- Escuadra de ángulo reforzada para ensamble de muebles.



CÓDIGO	MEDIDA	ACABADO	ENVASE
11250002020Z	20 X 20	CINCADO	100
11250003030Z	30 X 30	CINCADO	100
11250004040Z	40 X 40	CINCADO	100
11250005050Z	50 X 50	CINCADO	100
11250006060Z	60 X 60	CINCADO	100
11250008080Z	80 X 80	CINCADO	100

CÓDIGO	MEDIDA	ACABADO	ENVASE
11250007070B	70 X 70	BICROMATADO	100

1126 PLACA

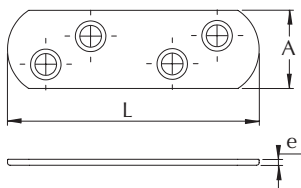

Medida (L)	40	50	60	80
A	19	19	19	19
e	1,5	1,5	1,5	1,5



- Pletina de unión y refuerzo para colgar y ensamblar muebles.

CÓDIGO	MEDIDA	ACABADO	ENVASE
11260000040Z	40	CINCADO	500
11260000050Z	50	CINCADO	500

CÓDIGO	MEDIDA	ACABADO	ENVASE
11260000060Z	60	CINCADO	100
11260000080Z	80	CINCADO	100

Medidas en mm.

1127 CONJUNTO COLGADOR

MODELO	Regulador	Placa
h	70	50
A	15	55

- Herraje de altura regulable para colgar muebles.

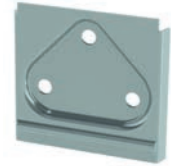
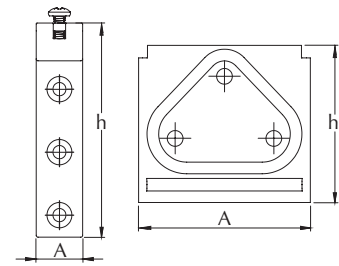

CÓDIGO	MEDIDA	ACABADO	ENVASE
11270001570Z	15 X 70	CINCADO	100

CÓDIGO	MEDIDA	ACABADO	ENVASE
11270005550Z	55 X 50	CINCADO	100

1159 PLACA ENGANCHE SOFÁ

L	47
A	92

- Herraje de unión de módulos de sofá.

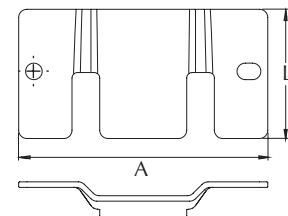

CÓDIGO	MEDIDA	ACABADO	ENVASE
11590004792Z	47 X 92	CINCADO	200

1128 ESCUADRA SOPORTE FORMA "U"

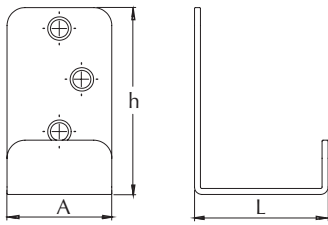

h	60
L	40
A	35



- Herraje forma U para colgar muebles.

CÓDIGO	MEDIDA	ACABADO	ENVASE
1128000000V	40 X 35	GALVANIZADO	200

1129 MUELLE BALANCÍN

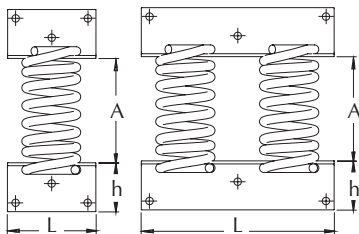

TIPO	Simple	Doble
h	30	30
L	60	130
A	60	60

- Muelle de 6 mm de diámetro de alambre.



CÓDIGO	MEDIDA	ACABADO	ENVASE
11290600001Z	6	CINCADO + GALV.	10

CÓDIGO	MEDIDA	ACABADO	ENVASE
11290600002Z	6	CINCADO + GALV.	10

1130 CUADRADILLO LISO

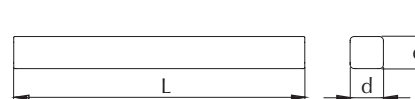

- Cuadradillo acero para pomos y manillas.



CÓDIGO	(d)	L	ACABADO	ENVASE
11300500045Z	5	45	CINCADO	500
11300500050Z	5	50	CINCADO	500
11300500060Z	5	60	CINCADO	500
11300500070Z	5	70	CINCADO	500
11300500080Z	5	80	CINCADO	500
11300600030Z	6	30	CINCADO	500
11300600035Z	6	35	CINCADO	500
11300600040Z	6	40	CINCADO	500
11300600045Z	6	45	CINCADO	500
11300600050Z	6	50	CINCADO	500
11300600055Z	6	55	CINCADO	500
11300600060Z	6	60	CINCADO	500
11300600065Z	6	65	CINCADO	200
11300600070Z	6	70	CINCADO	200
11300700040Z	7	40	CINCADO	200
11300700050Z	7	50	CINCADO	200

CÓDIGO	(d)	L	ACABADO	ENVASE
11300700060Z	7	60	CINCADO	200
11300700070Z	7	70	CINCADO	200
11300700075Z	7	75	CINCADO	200
11300700080Z	7	80	CINCADO	200
11300800040Z	8	40	CINCADO	200
11300800045Z	8	45	CINCADO	200
11300800050Z	8	50	CINCADO	200
11300800055Z	8	55	CINCADO	200
11300800060Z	8	60	CINCADO	200
11300800065Z	8	65	CINCADO	100
11300800070Z	8	70	CINCADO	100
11300800075Z	8	75	CINCADO	100
11300800080Z	8	80	CINCADO	100
11300800090Z	8	90	CINCADO	100
11300800110Z	8	110	CINCADO	100

1131 CUADRADILLO GRAFILADO

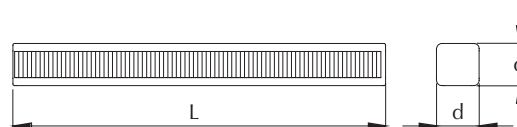

- Cuadradillo acero grafilado para pomos y manillas.



CÓDIGO	(d)	L	ACABADO	ENVASE
11310800070Z	8	70	CINCADO	500

CÓDIGO	(d)	L	ACABADO	ENVASE
11310800075Z	8	75	CINCADO	500

1134 VARILLA CUADRADA

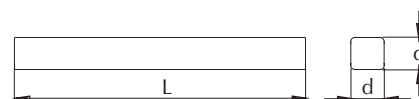

- Varilla cuadrada 3m.



CÓDIGO	MEDIDA	ENVASE
11340503000S	5 X 3000	5
11340603000S	6 X 3000	5

CÓDIGO	MEDIDA	ENVASE
11340703000S	7 X 3000	5
11340803000S	8 X 3000	5

Medidas en mm.

1135 LLAVE ALLEN L

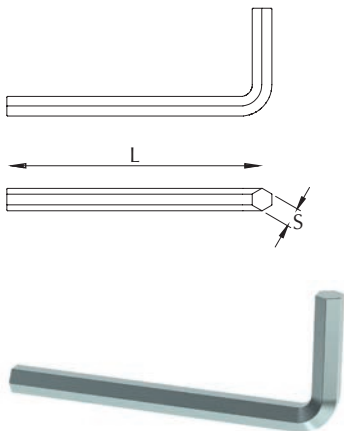

- Llave hexagonal forma L.

CÓDIGO	(S)	L (Máx.)	ACABADO	ENVASE
11350150000Z	1,5	50	CINCADO	500
11350200000Z	2	55	CINCADO	500
11350250000Z	2,5	60	CINCADO	500
11350300000Z	3	65	CINCADO	500
11350400000Z	4	75	CINCADO	500
11350500000Z	5	85	CINCADO	200

CÓDIGO	(S)	L (Máx.)	ACABADO	ENVASE
11350500060Z	5	60	CINCADO	200
11350600000Z	6	100	CINCADO	100
11350600060Z	6	65	CINCADO	100
11350800000Z	8	110	CINCADO	50
11351000000Z	10	120	CINCADO	50

1138 LLAVE ALLEN STAR 8.8

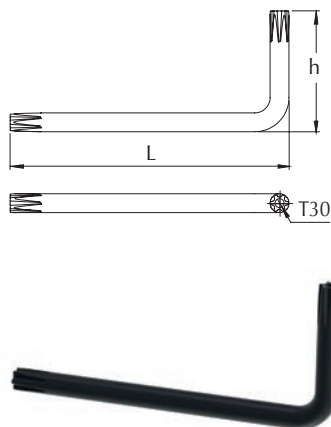

Medida	T30
h	30
L	75

- Llave hexalobular forma L alta resistencia.

CÓDIGO	⊗	ACABADO	ENVASE
11383000000P	T-30	PAVONADO	100

Medidas en mm.

## 1136 LLAVE ALLEN L ACERO TEMPLADO

- Llave hexagonal forma L alta resistencia.

CÓDIGO	MEDIDA (S)	ACABADO	ENVASE
11360150000P	1,5	PAVONADO	500
11360200000P	2	PAVONADO	500
11360250000P	2,5	PAVONADO	500
11360300000P	3	PAVONADO	500
11360400000P	4	PAVONADO	500

CÓDIGO	MEDIDA (S)	ACABADO	ENVASE
11360500000P	5	PAVONADO	200
11360600000P	6	PAVONADO	100
11360800000P	8	PAVONADO	100

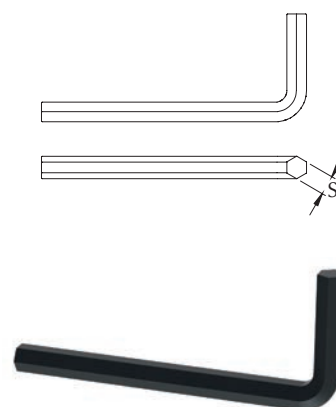

## 1137 LLAVE ALLEN Z

- Llave hexagonal forma Z.

CÓDIGO	MEDIDA (S)	ACABADO	ENVASE
11370300000Z	3	CINCADO	500
11370400000Z	4	CINCADO	500

CÓDIGO	MEDIDA (S)	ACABADO	ENVASE
11370500000Z	5	CINCADO	1000

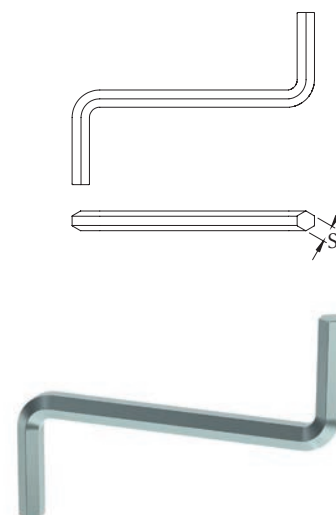

1139 LLAVE FIJA

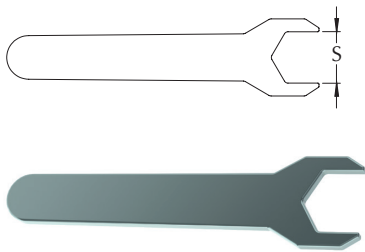

- Llave fija para tuercas y tornillos de cabeza hexagonal.

CÓDIGO	MEDIDA	ACABADO	ENVASE
11391000000Z	10	CINCADO	200

CÓDIGO	MEDIDA	ACABADO	ENVASE
11391300000Z	13	CINCADO	200

1140 BISAGRA LIBRO

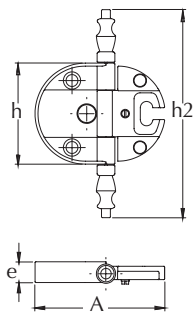

TIPO	Con remate
h	35
h2	70
A	43
e	7



- Bisagra estilo rústico.

CÓDIGO	TIPO	ACABADO	ENVASE
11400003543U	35 X 43	CUERO	24



1148 SOPORTE LATERAL BARRA ARMARIO

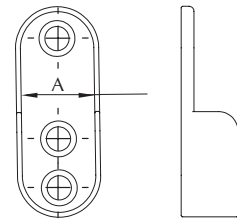

- Soporte para atornillar en los laterales interiores de los armarios.



CÓDIGO	A	ACABADO	ENVASE
11481500001Q	15 LISO	NIQUELADO	200



CÓDIGO	A	ACABADO	ENVASE
11481500002M	15 LISO	ALUMINIO MATE	100



CÓDIGO	A	ACABADO	ENVASE
11481500003M	15 GRAFILADO	ALUMINIO MATE	100

Medidas en mm.

### 1149 SOPORTE CENTRAL BARRA ARMARIO

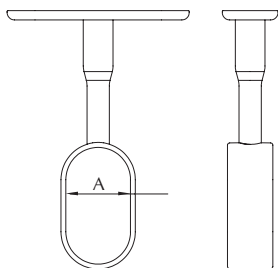

- Soporte para atornillar en la tapa interior de los armarios.

CÓDIGO	MEDIDA	ACABADO	ENVASE
11491500002M	15 X 30 X 70	ALUMINIO MATE	100

### 1150 BARRA ARMARIO

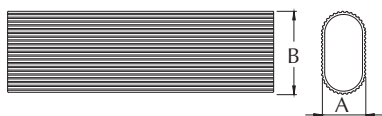

- Barra armario al corte.

CÓDIGO	MEDIDA	ACABADO	ENVASE
11501500002M	15 X 30	ALUMINIO MATE	1

Longitud barra: 3 ó 4 metros.  
Consultar cantidad mínima de servicio.



CÓDIGO	MEDIDA	ACABADO	ENVASE
11501500003M	15 X 30	ALUMINIO BRILLO	1

Longitud barra: 3 ó 4 metros.  
Consultar cantidad mínima de servicio.

Medidas en mm.

1151 JUEGO ENGANCHE ARMARIO

A 26

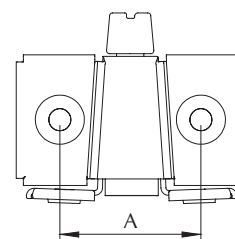

- Herraje para la unión de módulos de armario.

CÓDIGO	ACABADO	ENVASE
1151000000B	BICROMATADO	100

1153 ALCAYATA ROSCA MADERA

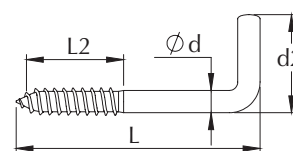

Medida	14x30	14x35	14x40	14x50	16x30	16x35	17x35	17x40	17x50	18x40	18x50	18x60	19x50	19x60
d ± 0,5	2,1	2,1	2,1	2,1	2,4	2,4	2,7	2,7	2,7	3	3	3	3,5	3,5
d2 ± 1,5	12	12	12	12	12	12	15	15	15	16	16	16	18	18
L ± 2,0	20	25	30	35	20	25	25	30	35	25	35	40	35	45
L2 ± 2,0	10	12	14	18	11	11	11	14	18	14	18	18	20	20

Medida	19x70	20x50	20x60	20x70	20x80	20x90	21x60	21x70	21x80	21x90	21X100	22x100	22X120	22X130
d ± 0,5	3,5	4	4	4	4	4	4,5	4,5	4,5	4,5	4,5	5	5	5
d2 ± 1,5	18	19	19	19	19	19	25	25	25	25	25	28	28	28
L ± 2,0	55	35	45	55	65	75	45	55	60	70	80	80	100	110
L2 ± 2,0	20	20	25	25	30	45	22	25	25	40	40	35	45	50

- Alcayata o escarpia para atornillar en madera o pared con taco.



CÓDIGO	MEDIDA	ACABADO	ENVASE
11531400025Z	14 X 25	CINCADO	1000
11531400030Z	14 X 30	CINCADO	600
11531400035Z	14 X 35	CINCADO	600
11531400040Z	14 X 40	CINCADO	600
11531400050Z	14 X 50	CINCADO	600
11531600030Z	16 X 30	CINCADO	600
11531600035Z	16 X 35	CINCADO	600
11531700035Z	17 X 35	CINCADO	600
11531700040Z	17 X 40	CINCADO	600
11531700050Z	17 X 50	CINCADO	600
11531800040Z	18 X 40	CINCADO	600
11531800050Z	18 X 50	CINCADO	600
11531800060Z	18 X 60	CINCADO	400
11531900050Z	19 X 50	CINCADO	400
11531900060Z	19 X 60	CINCADO	400

CÓDIGO	MEDIDA	ACABADO	ENVASE
11531900070Z	19 X 70	CINCADO	300
11532000050Z	20 X 50	CINCADO	400
11532000060Z	20 X 60	CINCADO	400
11532000070Z	20 X 70	CINCADO	200
11532000080Z	20 X 80	CINCADO	200
11532000090Z	20 X 90	CINCADO	200
11532100060Z	21 X 60	CINCADO	200
11532100070Z	21 X 70	CINCADO	200
11532100080Z	21 X 80	CINCADO	200
11532100090Z	21 X 90	CINCADO	200
11532100100Z	21 X 100	CINCADO	200
11532200100Z	22 X 100	CINCADO	200
11532200120Z	22 X 120	CINCADO	100
11532200130Z	22 X 130	CINCADO	100

Medidas en mm.

1154 CÁNCAMO CERRADO ROSCA MADERA

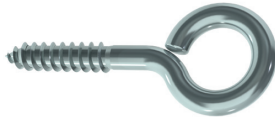
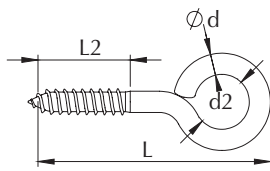

- Cáncamo o hembra cerrada para atornillar en madera o pared con taco.

Medida	14x25	16x30	16x35	17x35	17x40	17x50	18x40	18x50	18x60	19x50	19x60	20x50
d ± 0,5	2,1	2,4	2,4	2,7	2,7	2,7	3	3	3	3,5	3,5	4
d2 ± 0,5	5	5,5	5,5	6	6	6	7	7	7	9	9	10
L ± 2,0	20	20	25	25	29	35	32	36	41	38	43	38
L2 ± 2,0	8	11	11	11	14	18	16	18	18	20	20	20

Medida	20x60	20x70	20x80	20x90	21x60	21x70	21x80	21x90	21x100	22x100	22x120	22x130
d ± 0,5	4	4	4	4	4,5	4,5	4,5	4,5	4,5	5	5	5
d2 ± 0,5	10	10	10	10	13,5	13,5	13,5	13,5	13,5	16,5	16,5	16,5
L ± 2,0	44	49	54	59	46	51	56	61	66	64	74	79
L2 ± 2,0	20	25	30	40	22	22	25	30	40	25	40	45

CÓDIGO	MEDIDA	ACABADO	ENVASE
11541400025Z	14 X 25	CINCADO	1000
11541600030Z	16 X 30	CINCADO	600
11541600035Z	16 X 35	CINCADO	600
11541700035Z	17 X 35	CINCADO	600
11541700040Z	17 X 40	CINCADO	600
11541700050Z	17 X 50	CINCADO	600
11541800040Z	18 X 40	CINCADO	600
11541800050Z	18 X 50	CINCADO	600
11541800060Z	18 X 60	CINCADO	400
11541900050Z	19 X 50	CINCADO	400
11541900060Z	19 X 60	CINCADO	400
11542000050Z	20 X 50	CINCADO	400

CÓDIGO	MEDIDA	ACABADO	ENVASE
11542000060Z	20 X 60	CINCADO	400
11542000070Z	20 X 70	CINCADO	200
11542000080Z	20 X 80	CINCADO	200
11542000090Z	20 X 90	CINCADO	200
11542100060Z	21 X 60	CINCADO	200
11542100070Z	21 X 70	CINCADO	200
11542100080Z	21 X 80	CINCADO	200
11542100090Z	21 X 90	CINCADO	200
11542100100Z	21 X 100	CINCADO	200
11542200100Z	22 X 100	CINCADO	200
11542200120Z	22 X 120	CINCADO	100
11542200130Z	22 X 130	CINCADO	100

Medidas en mm.

1155 CÁNCAMO ABIERTO ROSCA MADERA

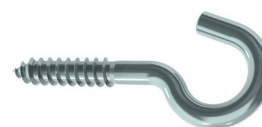
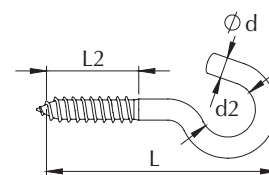

- Cáncamo o hembra abierta para atornillar en madera o pared con taco.

Medida	14x25	16x30	17x40	18x50	19x60	20x60	20x70	20x80
d ± 0,5	2,1	2,4	2,7	3	3,5	4	4	4
d2 ± 0,5	5	5,5	6	7	9	10	10	10
L ± 2,0	20	20	29	36	43	44	49	54
L2 ± 2,0	8	11	14	18	20	20	25	30

Medida	20x90	21x70	21x80	21x90	21x100	22x100	22x120	22x130
d ± 0,5	4	4,5	4,5	4,5	4,5	5	5	5
d2 ± 0,5	10	13,5	13,5	13,5	13,5	16,5	16,5	16,5
L ± 2,0	59	51	56	61	66	64	74	79
L2 ± 2,0	40	22	25	30	40	25	40	45

CÓDIGO	MEDIDA	ACABADO	ENVASE
11551400025Z	14 X 25	CINCADO	1000
11551600030Z	16 X 30	CINCADO	600
11551700040Z	17 X 40	CINCADO	600
11551800050Z	18 X 50	CINCADO	600
11551900050Z	19 X 50	CINCADO	400
11551900060Z	19 X 60	CINCADO	400
11552000060Z	20 X 60	CINCADO	400
11552000070Z	20 X 70	CINCADO	200
11552000080Z	20 X 80	CINCADO	200

CÓDIGO	MEDIDA	ACABADO	ENVASE
11552000090Z	20 X 90	CINCADO	200
11552100070Z	21 X 70	CINCADO	200
11552100080Z	21 X 80	CINCADO	200
11552100090Z	21 X 90	CINCADO	200
11552100100Z	21 X 100	CINCADO	200
11552200100Z	22 X 100	CINCADO	200
11552200120Z	22 X 120	CINCADO	100
11552200130Z	22 X 130	CINCADO	100

1156 RODILLO TRASLACIÓN

d	13
D	26

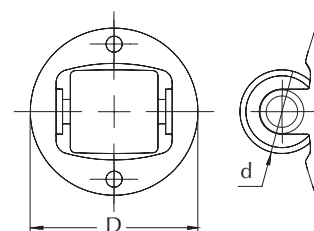

- Rodillo de traslación para muebles.



CÓDIGO	MEDIDA	ACABADO	ENVASE
1156130000V	13	GALVANIZADO	200

Medidas en mm.

1157 GRAPA PUENTE SENCILLA

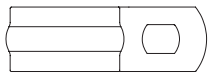

Medida (d)	6	8	10	12	14	16	18
Pulgadas			1/8"		1/4"		3/8"

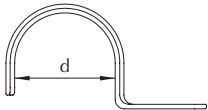

Medida (d)	20	22	25	26	30	32
Pulgadas		1/2"		3/4"		1"



- Grapa puente 1 pata para sujeción de tubos.

CÓDIGO	MEDIDA	ACABADO	ENVASE
11570600000Z	6	CINCADO	200
11570800000Z	8	CINCADO	200
11571000000Z	10	CINCADO	200
11571200000Z	12	CINCADO	100
11571400000Z	14	CINCADO	100
11571600000Z	16	CINCADO	100
11571800000Z	18	CINCADO	100

CÓDIGO	MEDIDA	ACABADO	ENVASE
11572000000Z	20	CINCADO	100
11572200000Z	22	CINCADO	100
11572500000Z	25	CINCADO	100
11572600000Z	26	CINCADO	100
11573000000Z	30	CINCADO	100
11573200000Z	32	CINCADO	100

1158 GRAPA PUENTE DOBLE

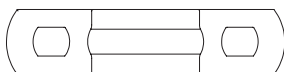

Medida (d)	8	10	12	14	16	18
Pulgadas		1/8"		1/4"		3/8"

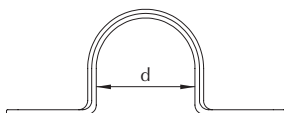

Medida (d)	20	22	25	26	30	32
Pulgadas		1/2"		3/4"		1"



- Grapa puente 2 patas para sujeción de tubos.

CÓDIGO	MEDIDA	ACABADO	ENVASE
11580800000Z	8	CINCADO	100
11581000000Z	10	CINCADO	100
11581200000Z	12	CINCADO	100
11581400000Z	14	CINCADO	100
11581600000Z	16	CINCADO	100

CÓDIGO	MEDIDA	ACABADO	ENVASE
11581800000Z	18	CINCADO	100
11582000000Z	20	CINCADO	100
11582500000Z	25	CINCADO	100
11583000000Z	30	CINCADO	50
11583200000Z	32	CINCADO	50

Medidas en mm.

A photograph of a truck driving on a road during sunset. The sky is filled with orange and red clouds. The truck is in the foreground, and the road stretches into the distance. A large white number '12' is overlaid at the bottom of the image.

REMACHES  
Y PASADORES

12

1201 REMACHE TUBULAR ALUMINIO ESTÁNDAR

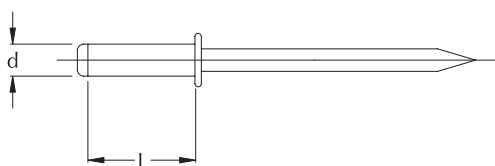

d	2,4	3	3,2	4	4,8	6	6,4
Ø cabeza	5	6,5	6,5	8	9,5	12	13
e cabeza	0,7	0,8	0,8	1	1,1	1,5	1,8
Ø taladro	2,5	3,1	3,3	4,1	4,9	6,1	6,5

- Remache ciego estándar de cabeza alomada con cuerpo de aluminio y mandril de acero.

CÓDIGO	(d)	L	ENVASE
12010240006M	2,4	6	1000
12010240008M	2,4	8	1000
12010240010M	2,4	10	1000
12010240012M	2,4	12	1000
12010300006M	3	6	1000
12010300008M	3	8	1000
12010300010M	3	10	1000
12010300012M	3	12	1000
12010300014M	3	14	1000
12010300016M	3	16	1000
12010300018M	3	18	1000
12010300020M	3	20	500
12010320006M	3,2	6	1000
12010320008M	3,2	8	1000
12010320010M	3,2	10	1000
12010320012M	3,2	12	1000
12010320014M	3,2	14	1000
12010320016M	3,2	16	1000
12010320018M	3,2	18	1000
12010320020M	3,2	20	500
12010320025M	3,2	25	500
12010400006M	4	6	1000
12010400008M	4	8	1000
12010400010M	4	10	1000
12010400012M	4	12	500
12010400014M	4	14	500
12010400016M	4	16	500
12010400018M	4	18	500
12010400020M	4	20	500
12010400023M	4	23	500
12010400025M	4	25	500
12010400030M	4	30	250
12010400035M	4	35	250
12010480006M	4,8	6	500
12010480008M	4,8	8	500

CÓDIGO	(d)	L	ENVASE
12010480010M	4,8	10	500
12010480012M	4,8	12	500
12010480014M	4,8	14	500
12010480016M	4,8	16	500
12010480018M	4,8	18	500
12010480020M	4,8	20	500
12010480022M	4,8	22	500
12010480025M	4,8	25	250
12010480028M	4,8	28	250
12010480030M	4,8	30	250
12010480035M	4,8	35	250
12010480040M	4,8	40	250
12010480045M	4,8	45	200
12010600008M	6	8	250
12010600010M	6	10	250
12010600012M	6	12	250
12010600014M	6	14	250
12010600016M	6	16	250
12010600018M	6	18	250
12010600020M	6	20	250
12010600022M	6	22	250
12010600026M	6	26	200
12010600030M	6	30	200
12010600035M	6	35	200
12010600040M	6	40	100
12010600045M	6	45	100
12010640010M	6,4	10	250
12010640012M	6,4	12	250
12010640015M	6,4	15	250
12010640018M	6,4	18	250
12010640022M	6,4	22	250
12010640026M	6,4	26	200
12010640030M	6,4	30	200
12010640035M	6,4	35	200
12010640040M	6,4	40	100

Medidas en mm.



## 1202 REMACHE TUBULAR ALUMINIO ALA ANCHA

d	3,2	4	4,8	4,8	6
D	9,5	12	14	16	18
e cabeza	2	2,5	2,5	2,5	1,5
Ø taladro	3,3	4,1	4,9	4,9	6,1

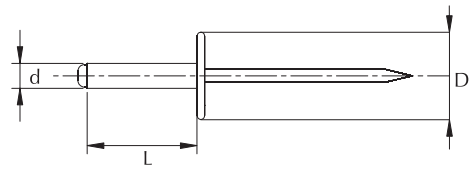

- Remache ciego de cabeza ancha con cuerpo de aluminio y mandril de acero.

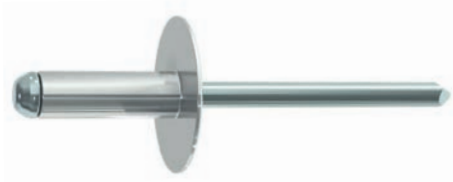

CÓDIGO	(d)	L	ALA ANCHA	ENVASE
12020320908M	3,2	8	9,5	500
12020320910M	3,2	10	9,5	500
12020320912M	3,2	12	9,5	500
12020320914M	3,2	14	9,5	500
12020320916M	3,2	16	9,5	500
12020320918M	3,2	18	9,5	500
12020401208M	4	8	12	500
12020401210M	4	10	12	500
12020401212M	4	12	12	500
12020401214M	4	14	12	500
12020401216M	4	16	12	500
12020401218M	4	18	12	500
12020401220M	4	20	12	250
12020481408M	4,8	8	14	500
12020481410M	4,8	10	14	250
12020481412M	4,8	12	14	250
12020481414M	4,8	14	14	250
12020481416M	4,8	16	14	250
12020481418M	4,8	18	14	250
12020481420M	4,8	20	14	250

CÓDIGO	(d)	L	ENVASE	
12020481424M	4,8	24	14	250
12020481428M	4,8	28	14	200
12020481430M	4,8	30	14	200
12020481435M	4,8	35	14	150
12020481610M	4,8	10	16	250
12020481612M	4,8	12	16	250
12020481614M	4,8	14	16	250
12020481616M	4,8	16	16	250
12020481618M	4,8	18	16	250
12020481620M	4,8	20	16	250
12020481622M	4,8	22	16	250
12020481624M	4,8	24	16	250
12020481626M	4,8	26	16	250
12020481628M	4,8	28	16	200
12020481630M	4,8	30	16	200
12020481635M	4,8	35	16	200
12020601810M	6	10	18	250
12020601816M	6	16	18	250
12020601821M	6	21	18	250

1204 REMACHE TUBULAR FLOR ALUMINIO

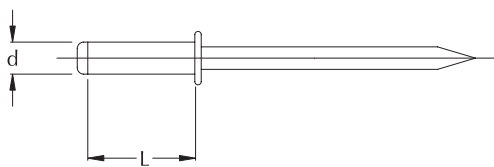

d	4	4,8
Ø cabeza	8	9
e cabeza	1,2	1,4
Ø taladro	4,5	5,3

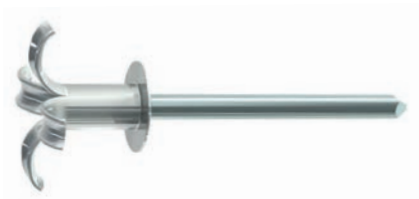

- Remache ciego en forma de flor con cuerpo de aluminio y mandril de acero.

CÓDIGO	( d )	L	ENVASE
12040400010M	4	10	1000
12040400012M	4	12	500
12040400014M	4	14	500
12040400016M	4	16	500
12040400018M	4	18	500
12040400020M	4	20	500
12040400025M	4	25	500
12040400030M	4	30	500
12040480010M	4,8	10	500

CÓDIGO	( d )	L	ENVASE
12040480012M	4,8	12	500
12040480014M	4,8	14	500
12040480016M	4,8	16	500
12040480018M	4,8	18	500
12040480020M	4,8	20	500
12040480025M	4,8	25	250
12040480030M	4,8	30	250
12040480035M	4,8	35	250

Medidas en mm.

1205 REMACHE TUBULAR ACERO

d	3	3,2	4	4,8	6	6,4
Ø cabeza	6,5	6,5	8	9,5	12	13
e cabeza	0,8	0,8	1	1,1	1,5	1,8
Ø taladro	3,1	3,3	4,1	4,9	6,1	6,5

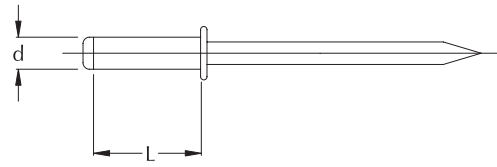

- Remache ciego estándar de acero.

CÓDIGO	(d)	L	ENVASE
12050300006S	3	6	1000
12050300008S	3	8	1000
12050300010S	3	10	1000
12050300012S	3	12	1000
12050300016S	3	16	1000
12050300018S	3	18	1000
12050300020S	3	20	500
12050320006S	3,2	6	1000
12050320008S	3,2	8	1000
12050320010S	3,2	10	1000
12050320012S	3,2	12	1000
12050320014S	3,2	14	1000
12050320016S	3,2	16	1000
12050320018S	3,2	18	1000
12050320020S	3,2	20	500
12050400006S	4	6	500
12050400008S	4	8	1000
12050400010S	4	10	1000
12050400012S	4	12	500
12050400016S	4	16	500
12050400018S	4	18	500
12050400020S	4	20	500
12050400022S	4	22	500
12050400025S	4	25	500
12050400030S	4	30	500
12050480006S	4,8	6	500

CÓDIGO	(d)	L	ENVASE
12050480008S	4,8	8	500
12050480010S	4,8	10	500
12050480012S	4,8	12	500
12050480014S	4,8	14	500
12050480016S	4,8	16	500
12050480018S	4,8	18	500
12050480020S	4,8	20	500
12050480022S	4,8	22	500
12050480025S	4,8	25	250
12050480030S	4,8	30	250
12050600010S	6	10	250
12050600012S	6	12	250
12050600015S	6	15	250
12050600018S	6	18	250
12050600022S	6	22	250
12050600026S	6	26	250
12050600030S	6	30	250
12050640008S	6,4	8	250
12050640010S	6,4	10	250
12050640012S	6,4	12	250
12050640015S	6,4	15	250
12050640018S	6,4	18	250
12050640022S	6,4	22	250
12050640026S	6,4	26	200
12050640030S	6,4	30	200

1207 REMACHE TUBULAR TRÉBOL ALUMINIO

d	4	4,8
Ø cabeza	8	9,6
e cabeza	1,4	1,6
Ø taladro	4,2	5

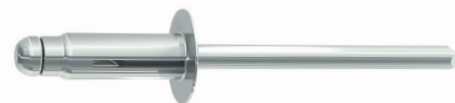
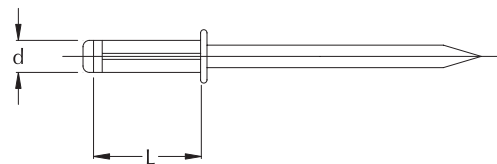

- Remache ciego en forma de trébol de aluminio.

CÓDIGO	(d)	L	ENVASE
12070400013M	4	13,6	500
12070400018M	4	18,8	500
12070400024M	4	24	500

CÓDIGO	(d)	L	ENVASE
12070480015M	4,8	15,3	500
12070480020M	4,8	20,5	400
12070480024M	4,8	24,5	250

Medidas en mm.

1208 REMACHE TUBULAR CABEZA AVELLANADA ALUMINIO

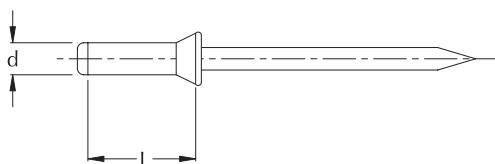

d	3,2	4	4,8
Ø cabeza	6	7,5	9
e cabeza	0,9	1	1,2
Ø taladro	3,3	4,1	4,9



- Remache ciego de cabeza plana con cuerpo de aluminio y mandril de acero.

CÓDIGO	(d)	L	ENVASE
12080320006M	3,2	6	1000
12080320008M	3,2	8	1000
12080320010M	3,2	10	1000
12080320012M	3,2	12	1000
12080320014M	3,2	14	1000
12080320016M	3,2	16	1000
12080400006M	4	6	1000
12080400008M	4	8	1000
12080400010M	4	10	1000
12080400012M	4	12	500
12080400014M	4	14	500
12080400016M	4	16	500
12080400018M	4	18	500

CÓDIGO	(d)	L	ENVASE
12080400020M	4	20	500
12080480006M	4,8	6	500
12080480008M	4,8	8	500
12080480010M	4,8	10	500
12080480012M	4,8	12	500
12080480014M	4,8	14	500
12080480016M	4,8	16	500
12080480018M	4,8	18	500
12080480020M	4,8	20	500
12080480025M	4,8	25	500
12080480030M	4,8	30	250
12080480035M	4,8	35	250

Disponibilidad remache aluminio tubular lacado en diferentes colores, según gama RAL. Consúltenos.



Medidas en mm.

1209 REMACHE SEMITUBULAR

d	4	5	6	7
D	6,9	8,5	10	21
K	1,7	2,2	2,5	2,8
A	2,8	3,5	4,2	4,9
P	4	4,7	5,2	6

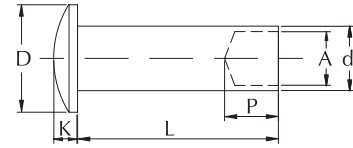

- Remache ciego de acero bajo en carbono cincado.

CÓDIGO	( d )	L	ENVASE
12090400010Z	4	10	10.000
12090400014Z	4	14	10.000
12090400020Z	4	20	10.000
12090400026Z	4	26	7.500
12090400028Z	4	28	7.000
12090400030Z	4	30	6.900
12090400035Z	4	35	5.800
12090400040Z	4	40	5.000
12090400045Z	4	45	4.000
12090500010Z	5	10	10.000
12090500020Z	5	20	6.100
12090500025Z	5	25	5.000
12090500027Z	5	27	4.700
12090500030Z	5	30	4.200
12090500035Z	5	35	3.700
12090500036Z	5	36	3.600

CÓDIGO	( d )	L	ENVASE
12090500040Z	5	40	3.200
12090500045Z	5	45	2.900
12090600010Z	6	10	7.500
12090600016Z	6	16	5.000
12090600020Z	6	20	4.000
12090600026Z	6	26	3.300
12090600030Z	6	30	2.900
12090600035Z	6	35	2.500
12090600040Z	6	40	2.200
12090600042Z	6	42	2.100
12090600045Z	6	45	2.000
12090600050Z	6	50	1.800
12090600055Z	6	55	1.500
12090600060Z	6	60	1.500
12090700012Z	7	12	1.000

Consultar cantidad mínima de servicio.

Fabricación de remaches macizos y semitubulares a medida. Consúltenos.

Medidas en mm.

1210 PASADOR ELÁSTICO DIN 1481

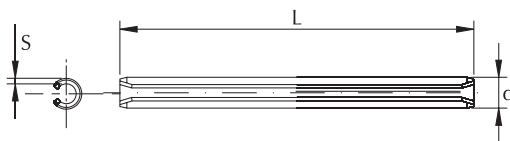

Ø aplicación	2	2,5	3	3,5	4
S	0,4	0,5	0,6	0,75	0,8
d	2,3/+0,1	2,8/+0,1	3,3/+0,2	3,8/+0,2	4,4/+0,2

Ø aplicación	5	6	7	8	10
S	1	1,25	1,25	1,25	2
d	5,4/+0,2	6,4/+0,3	7,4/+0,3	8,4/+0,3	10,5/+0,3

- El pasador cilíndrico con una ranura longitudinal.
- Cuando el pasador queda introducido en el taladro, queda comprimido y retenido debido a la fuerza elástica ejercida contra las paredes de dicho taladro.
- La ranura se reduce en anchura, pero sigue permaneciendo abierta.

CÓDIGO	(d)	L	ENVASE
12100200008S	2	8	1000
12100200010S	2	10	1000
12100200012S	2	12	1000
12100200014S	2	14	1000
12100200016S	2	16	1000
12100200020S	2	20	1000
12100200022S	2	22	1000
12100250005S	2,5	5	1000
12100250014S	2,5	14	1000
12100300008S	3	8	1000
12100300010S	3	10	1000
12100300012S	3	12	1000
12100300014S	3	14	1000
12100300016S	3	16	1000
12100300020S	3	20	1000
12100300022S	3	22	1000
12100300024S	3	24	1000
12100300028S	3	28	1000
12100300030S	3	30	1000
12100300040S	3	40	1000
12100300050S	3	50	1000
12100350008S	3,5	8	1000
12100350010S	3,5	10	1000
12100350012S	3,5	12	1000
12100350014S	3,5	14	1000
12100350016S	3,5	16	1000
12100350020S	3,5	20	1000
12100350022S	3,5	22	1000
12100350024S	3,5	24	1000
12100350028S	3,5	28	1000
12100350030S	3,5	30	1000
12100350040S	3,5	40	1000
12100350050S	3,5	50	1000
12100400008S	4	8	500
12100400010S	4	10	500
12100400012S	4	12	500
12100400014S	4	14	500
12100400016S	4	16	500
12100400020S	4	20	500
12100400022S	4	22	500
12100400024S	4	24	500
12100400028S	4	28	500
12100400030S	4	30	500
12100400040S	4	40	500

CÓDIGO	(d)	L	ENVASE
12100400050S	4	50	500
12100500010S	5	10	500
12100500012S	5	12	500
12100500014S	5	14	500
12100500016S	5	16	500
12100500020S	5	20	500
12100500022S	5	22	500
12100500024S	5	24	500
12100500025S	5	25	500
12100500028S	5	28	500
12100500030S	5	30	500
12100500040S	5	40	500
12100500050S	5	50	500
12100500060S	5	60	500
12100600016S	6	16	500
12100600020S	6	20	500
12100600022S	6	22	500
12100600024S	6	24	500
12100600028S	6	28	500
12100600030S	6	30	500
12100600040S	6	40	500
12100600050S	6	50	500
12100600060S	6	60	500
12100700024S	7	24	200
12100700040S	7	40	200
12100800016S	8	16	200
12100800020S	8	20	200
12100800022S	8	22	200
12100800024S	8	24	200
12100800028S	8	28	200
12100800030S	8	30	200
12100800040S	8	40	200
12100800050S	8	50	200
12100800060S	8	60	200
12100800080S	8	80	200
12101000020S	10	20	100
12101000022S	10	22	100
12101000024S	10	24	100
12101000028S	10	28	100
12101000030S	10	30	100
12101000040S	10	40	100
12101000050S	10	50	100
12101000060S	10	60	100

Medidas en mm.

1213 PASADOR-R

d	2	2,5	3	3,5	4	4,5	5	6	7
L	42	42	57	57	67	67	90	90	100

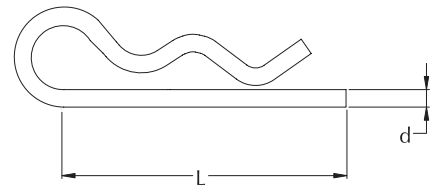

- También llamado pasador Beta para montaje en elementos perforados.
- Principales aplicaciones en bricolaje o agricultura.
- Material acero cincado.

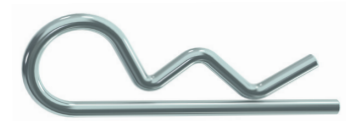

CÓDIGO	MEDIDA	ACABADO	ENVASE
12130200000Z	2	CINCADO	100
12130250000Z	2,5	CINCADO	100
12130300000Z	3	CINCADO	100
12130350000Z	3,5	CINCADO	100
12130400000Z	4	CINCADO	100

CÓDIGO	MEDIDA	ACABADO	ENVASE
12130450000Z	4,5	CINCADO	100
12130500000Z	5	CINCADO	50
12130600000Z	6	CINCADO	50
12130700000Z	7	CINCADO	25

1212 PASADOR CENTRO EJE

MEDIDA	6 X 45	7 X 40	7 X 50	8 X 40	8 X 50	8 X 60	10 X 50	10 X 60	12 X 50	12 X 80
d X L	5,9 X 45	6,9 X 40	6,9 X 50	7,9 X 40	7,9 X 50	7,9 X 60	9,9 X 50	9,9 X 60	11,9 X 50	11,9 X 80

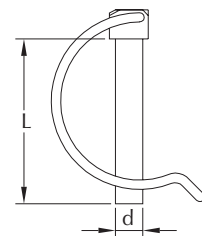

- Pasador centro eje para montaje en tubos perforados.
- Principales aplicaciones en bricolaje o agricultura.
- Material acero cincado.



CÓDIGO	(d)	L	ENVASE
12120600045Z	6	45	50
12120700040Z	7	40	50
12120700050Z	7	50	50
12120800040Z	8	40	50
12120800050Z	8	50	50

CÓDIGO	(d)	L	ENVASE
12120800060Z	8	60	50
12121000050Z	10	50	50
12121000060Z	10	60	50
12121200050Z	12	50	50
12121200080Z	12	80	50

Medidas en mm.

1211 PASADOR ANILLA

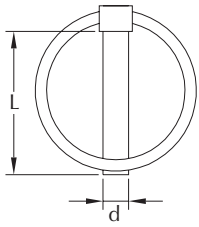

MEDIDA	4,5 X 37	6 X 37	7 X 40	8 X 46	9 X 46	10 X 46	10 x 60	11 X 46
d X L	4,3 X 37	5,8 X 37	6,8 X 40	7,8 X 46	8,8 X 46	9,8 X 46	9,8 X 60	10,8 X 46



- Pasador de anilla DIN 11023 para montaje en ejes o tubos perforados.
- La anilla se cierra con presión evitando que el elemento fijado se salga del eje.
- Principales aplicaciones en bricolaje o agricultura.
- Material acero cincado.

CÓDIGO	( d )	L	ENVASE
12110450037Z	4,5	37	100
12110600037Z	6	37	100
12110700040Z	7	40	100
12110800046Z	8	46	50

CÓDIGO	( d )	L	ENVASE
12110900046Z	9	46	50
12111000046Z	10	46	50
12111000060Z	10	60	50
12111100046Z	11	46	50

Medidas en mm.





PUNTAS Y ÚTILES  
PARA ATORNILLAR

13

## 1301 PUNTA POZI TIPO A



- Punta PZ de alta resistencia y recubrimiento de Nitruro de Titanio.
- Este recubrimiento proporciona una vida de 4 a 10 veces superior en resistencia al desgaste y una rugosidad superficial que minimiza el efecto de expulsión en el atornillado.
- Ideal para aplicaciones industriales y trabajos intensivos en serie.
- Dureza 60-62 HRC.

CÓDIGO	⊕	L	MEDIDA	ENVASE
13010001425S	PZ0	25	PZ0 1/4" X 25	5
13010101425S	PZ1	25	PZ1 1/4" X 25	5
13010101450S	PZ1	50	PZ1 1/4" X 50	5
13010201425S	PZ2	25	PZ2 1/4" X 25	5

CÓDIGO	⊕	L	MEDIDA	ENVASE
13010201450S	PZ2	50	PZ2 1/4" X 50	5
13010301425S	PZ3	25	PZ3 1/4" X 25	5
13010301450S	PZ3	50	PZ3 1/4" X 50	5

## 1302 PUNTA PHILIPS TIPO A



- Punta PH de alta resistencia y recubrimiento de Nitruro de Titanio.
- Este recubrimiento proporciona una vida de 4 a 10 veces superior en resistencia al desgaste y una rugosidad superficial que minimiza el efecto de expulsión en el atornillado.
- Ideal para aplicaciones industriales y trabajos intensivos en serie.
- Dureza 60-62 HRC.

CÓDIGO	⊕	L	MEDIDA	ENVASE
13020101425S	PH1	25	PH1 1/4" X 25	5
13020101450S	PH1	50	PH1 1/4" X 50	5
13020201425S	PH2	25	PH2 1/4" X 25	5

CÓDIGO	⊕	L	MEDIDA	ENVASE
13020201450S	PH2	50	PH2 1/4" X 50	5
13020301425S	PH3	25	PH3 1/4" X 25	5
13020301450S	PH3	50	PH3 1/4" X 50	5

## 1303 PUNTA ALLEN TIPO A

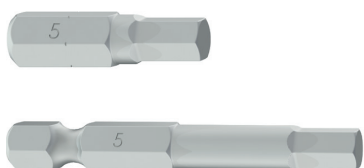

- Punta ALLEN de alta resistencia.
- Ideal para aplicaciones industriales y trabajos intensivos en serie. Dureza 60-62 HRC.
- Para aplicaciones universales: en materiales blandos, madera, materiales duros, metal.

CÓDIGO	○	L	MEDIDA	ENVASE
13030201425S	2	25	2 1/4" X 25	5
13030201450S	2	50	2 1/4" X 50	5
13030251425S	2,5	25	2,5 1/4" X 25	5
13030251450S	2,5	50	2,5 1/4" X 50	5
13030301425S	3	25	3 1/4" X 25	5
13030301450S	3	50	3 1/4" X 50	5
13030401425S	4	25	4 1/4" X 25	5

CÓDIGO	○	L	MEDIDA	ENVASE
13030401450S	4	50	4 1/4" X 50	5
13030501425S	5	25	5 1/4" X 25	5
13030501450S	5	50	5 1/4" X 50	5
13030601425S	6	25	6 1/4" X 25	5
13030601450S	6	50	6 1/4" X 50	5
13030801425S	8	25	8 1/4" X 25	5
13031001425S	10	25	10 1/4" X 25	5

Medidas en mm.

1304 PUNTA STAR TIPO A

- Punta STAR de alta resistencia. Ideal para aplicaciones industriales y trabajos intensivos en serie.
- Dureza 60-62 HRC.
- Para aplicaciones universales: en materiales blandos, madera, materiales duros, metal.

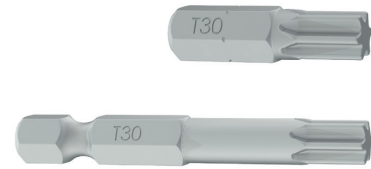

CÓDIGO	Ø	L	MEDIDA	ENVASE
13041001425S	T10	25	T10 1/4" X 25	5
13041001450S	T10	50	T10 1/4" X 50	5
13041501425S	T15	25	T15 1/4" X 25	5
13041501450S	T15	50	T15 1/4" X 50	5
13042001425S	T20	25	T20 1/4" X 25	5
13042001450S	T20	50	T20 1/4" X 50	5

CÓDIGO	Ø	L	MEDIDA	ENVASE
13042501425S	T25	25	T25 1/4" X 25	5
13042501450S	T25	50	T25 1/4" X 50	5
13043001425S	T30	25	T30 1/4" X 25	5
13043001450S	T30	50	T30 1/4" X 50	5
13044001425S	T40	25	T40 1/4" X 25	5
13044001450S	T40	50	T40 1/4" X 50	5

1305 PUNTA STAR INVOLABLE TIPO A

- Punta STAR INVOLABLE de alta resistencia.
- Ideal para aplicaciones industriales y trabajos intensivos en serie.
- Dureza 60-62 HRC.
- Para aplicaciones universales: en materiales blandos, madera, materiales duros, metal.



CÓDIGO	Ø	L	MEDIDA	ENVASE
13051001425S	T10	25	T10 1/4" X 25	5
13051501425S	T15	25	T15 1/4" X 25	5
13052001425S	T20	25	T20 1/4" X 25	5

CÓDIGO	Ø	L	MEDIDA	ENVASE
13052501425S	T25	25	T25 1/4" X 25	5
13053001425S	T30	25	T30 1/4" X 25	5
13054001425S	T40	25	T40 1/4" X 25	5

1306 PUNTA POZI TIPO B

- Punta PZ para aplicaciones universales.
- Ideal para madera y materiales blandos.



CÓDIGO	Ø	L	MEDIDA	ENVASE
13060001425S	PZ0	25	PZ0 1/4" X 25	5
13060001450S	PZ0	50	PZ0 1/4" X 50	5
13060101425S	PZ1	25	PZ1 1/4" X 25	5
13060101450S	PZ1	50	PZ1 1/4" X 50	5

CÓDIGO	Ø	L	MEDIDA	ENVASE
13060201425S	PZ2	25	PZ2 1/4" X 25	5
13060201450S	PZ2	50	PZ2 1/4" X 50	5
13060301425S	PZ3	25	PZ3 1/4" X 25	5
13060301450S	PZ3	50	PZ3 1/4" X 50	5

Medidas en mm.

## 1307 PUNTA PHILIPS TIPO B



- Punta PH para aplicaciones universales.
- Ideal para madera y materiales blandos.

CÓDIGO	⊕	L	MEDIDA	ENVASE
13070101425S	PH1	25	PH1 1/4" X 25	5
13070101450S	PH1	50	PH1 1/4" X 50	5
13070201425S	PH2	25	PH2 1/4" X 25	5

CÓDIGO	⊕	L	MEDIDA	ENVASE
13070201450S	PH2	50	PH2 1/4" X 50	5
13070301425S	PH3	25	PH3 1/4" X 25	5
13070301450S	PH3	50	PH3 1/4" X 50	5

## 1308 PUNTA STAR TIPO B



- Punta STAR para aplicaciones universales.
- Ideal para madera y materiales blandos.

CÓDIGO	⊕	L	MEDIDA	ENVASE
13081001425S	T10	25	T10 1/4" X 25	5
13081001450S	T10	50	T10 1/4" X 50	5
13081501425S	T15	25	T15 1/4" X 25	5
13081501450S	T15	50	T15 1/4" X 50	5
13082001425S	T20	25	T20 1/4" X 25	5
13082001450S	T20	50	T20 1/4" X 50	5

CÓDIGO	⊕	L	MEDIDA	ENVASE
13082501425S	T25	25	T25 1/4" X 25	5
13082501450S	T25	50	T25 1/4" X 50	5
13083001425S	T30	25	T30 1/4" X 25	5
13083001450S	T30	50	T30 1/4" X 50	5
13084001425S	T40	25	T40 1/4" X 25	5

## 1309 BIT ROSCADOR POZI



- Punta PZ con rosca de alta resistencia.
- Ideal para aplicaciones industriales y trabajos intensivos en serie.
- Dureza 60-62 HRC.
- Para aplicaciones universales: en materiales blandos, madera, materiales duros, metal.

CÓDIGO	⊕	L	MEDIDA	ENVASE
13090100433S	PZ1	33	PZ1 M4 X 33	1
13090200433S	PZ2	33	PZ2 M4 X 33	1
13090200533S	PZ2	33	PZ2 M5 X 33	1

CÓDIGO	⊕	L	MEDIDA	ENVASE
13090200545S	PZ2	45	PZ2 M5 X 45	1
13090200645S	PZ2	45	PZ2 M6 X 45	1

Medidas en mm.

**1310 BIT ROSCADOR STAR**

- Punta STAR con rosca de alta resistencia.
- Ideal para aplicaciones industriales y trabajos intensivos en serie.
- Dureza 60-62 HRC.
- Para aplicaciones universales: en materiales blandos, madera, materiales duros, metal.



CÓDIGO	Ø	L	MEDIDA	ENVASE
13101000500S	T10	M5	T10 M5	1
13101500500S	T15	M5	T15 M5	1

CÓDIGO	Ø	L	MEDIDA	ENVASE
13102000500S	T20	M5	T20 M5	1
13102500500S	T25	M5	T25 M5	1

**1311 ÚTIL ALLEN PARA TUERCA EMBUTIR**

- Acoplamiento hexagonal para inserción de tuercas de embutir en madera.



CÓDIGO	Ø	L	MEDIDA	ENVASE
13110300025S	3	25	3 X 25	1
13110400025S	4	25	4 X 25	1
13110500025S	5	25	5 X 25	1
13110600025S	6	25	6 X 25	1

CÓDIGO	Ø	L	MEDIDA	ENVASE
13110800025S	8	25	8 X 25	1
13110900030S	9	30	9 X 30	1
13111000030S	10	30	10 X 30	1

**1312 ACOPLAMIENTO PARA ESPÁRRAGO**

- Acoplamiento hexagonal con rosca interior para inserción de espárragos métricos.



CÓDIGO	(d)	L	MEDIDA	ENVASE
13120601450Q	M6	50	M6 1/4" X 50	1
13120801450Q	M8	50	M8 1/4" X 50	1

CÓDIGO	(d)	L	MEDIDA	ENVASE
13121001450Q	M10	50	M10 1/4" X 50	1

Medidas en mm.

### 1313 SOPORTE UNIVERSAL IMANTADO

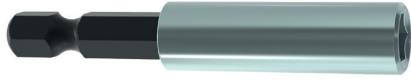

- Adaptador portapuntas imantado para facilitar la colocación y retirada de la punta.
- Para puntas de ¼".
- Acero inoxidable.

CÓDIGO	(d)	L	MEDIDA	ENVASE
13131000060S	10	60	10 X 60	1

CÓDIGO	(d)	L	MEDIDA	ENVASE
13131000075S	10	75	10 X 75	1

### 1314 SOPORTE UNIVERSAL CAMBIO RÁPIDO

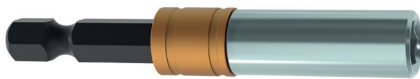

- Adaptador portapuntas imantado para facilitar la colocación y retirada de la punta con un mecanismo automático.
- Ajuste más seguro de la punta.
- Para puntas de ¼".
- Acero inoxidable.

CÓDIGO	(d)	L	MEDIDA	ENVASE
13141400066S	14	66	14 X 66	1

### 1315 ADAPTADOR PARA LLAVE MAGNÉTICO



- Vaso hexagonal imantado para colocar tornillos de cabeza hexagonal.
- La cabeza hexagonal lobular incrementa la superficie de contacto con la cabeza del tornillo. Sus lados ligeramente redondeados mejoran el agarre y no dañan el tornillo. De esta forma proporcionan una longevidad mayor a la herramienta.
- Cromo vanadio, acabado níquelado.

CÓDIGO	(d)	L	MEDIDA	ENVASE
13150550065Q	5,5	65	5,5 X 65	1
13150600065Q	6	65	6 X 65	1
13150700065Q	7	65	7 X 65	1
13150800065Q	8	65	8 X 65	1
13151000065Q	10	65	10 X 65	1

CÓDIGO	(d)	L	MEDIDA	ENVASE
13151100065Q	11	65	11 X 65	1
13151200065Q	12	65	12 X 65	1
13151300065Q	13	65	13 X 65	1
13151500065Q	15	65	15 X 65	1
13151700065Q	17	65	17 X 65	1

Medidas en mm.



**CADENA,  
ACCESORIOS PARA  
CABLES Y  
ELEMENTOS DE  
ELEVACIÓN**

**15**

1523 CADENA COMERCIAL CINCADE

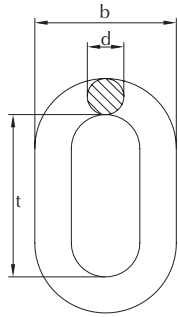

ø (d)	2	2,5	3	4	5	6	7	8	9	10	12	14	16
t	15,0	15,0	18,0	21,0	26,0	27,5	31,0	36,0	36,5	42,0	43,0	48,0	56,0
b	10,0	11,5	11	15,0	19,0	23,0	26,0	31,0	33,5	36,0	40,0	49,0	54,0
Carga (N)	250	375	560	1.000	1.575	2.250	3.000	4.000	5.000	6.250	9.000	18.400	24.000



• Cadena comercial en formato bobina.

CÓDIGO	Ø (d)	Mts./BOBINA	ENVASE
15230200000Z	2	300	1
15230250000Z	2,5	200	1
15230300000Z	3	150	1
15230400000Z	4	80	1
15230500000Z	5	50	1
15230600000Z	6	30	1
15230700000Z	7	20	1

CÓDIGO	Ø (d)	Mts./BOBINA	ENVASE
15230800000Z	8	15	1
15230900000Z	9	13	1
15231000000Z	10	10	1
15231200000Z	12	7	1
15231400000Z	14	5	1
15231600000Z	16	4	1

1524 CADENA ALTA RESISTENCIA GRADO 80

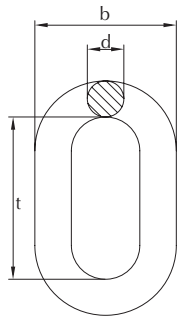

ø (d)	6	8	10	13	16
t	18,0	24,0	30,0	39,0	48,0
b	22,2	29,6	37,0	48,1	59,2
Carga (Kg)	1.000	2.000	3.000	5.000	8.000



• Cadena de alta resistencia grado 80.

CÓDIGO	Ø (d)	Mts./BOBINA	ENVASE
15240600000P	6	25	1
15240800000P	8	25	1
15241000000P	10	10	1

CÓDIGO	Ø (d)	Mts./BOBINA	ENVASE
15241300000P	13	10	1
15241600000P	16	8	1

Medidas en mm.



3525 DIN 5685 AISI 316 INOXIDABLE

ø (d)	2	3	4	5	6	7	8	10	12
t	12,0	16,0	19,0	21,0	24,0	28,0	32,0	40,0	48,0
b	8,0	12,0	16,0	20,0	24,0	28,0	32,0	40,0	48,0
Carga (N)	250	560	1.000	1.575	2.250	3.000	4.000	6.250	9.000

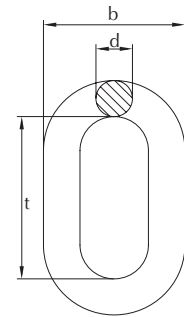

- Cadena din 5685A de eslabón semilargo de acero inoxidable AISI 316 formato bobina.



CÓDIGO	Ø (d)	Mts./BOBINA	ENVASE
35250200000A4	2,0	60,0	1
35250300000A4	3,0	60,0	1
35250400000A4	4,0	50,0	1
35250500000A4	5,0	30,0	1
35250600000A4	6,0	30,0	1

CÓDIGO	Ø (d)	Mts./BOBINA	ENVASE
35250700000A4	7,0	25,0	1
35250800000A4	8,0	20,0	1
35251000000A4	10,0	10,0	1
35251200000A4	12,0	8,0	1

1530 REGULADOR DE CABLE

Ø cable	A	B	d	D	Soporte carga (Kg)
0,8-1,2	16	17,5	1,7	3,4	10-50
1,5-2	19,5	22	2,7	5	20-90
2,5-3	30	30	3,5	6,7	150-350

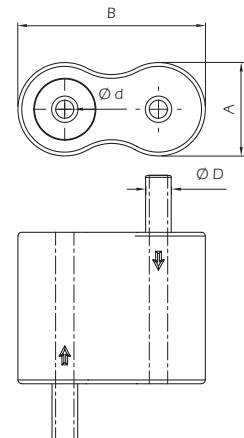

- El regulador de acero aleado para cable es un dispositivo bidireccional diseñado para crear lazos ajustables con cables o cuerdas que tengan el diámetro pequeño.
- Su funcionamiento autoblocante elimina la utilización de herramientas y accesorios de prensado, haciendo que su montaje sea más fácil, rápido y económico.
- Garantiza la fijación de cualquier tipo de material que deba permanecer suspendidos en un determinado espacio o lugar.



CÓDIGO	Ø CABLE	ENVASE
15300080001Q	0,8-1,2	100
15300150002Q	1,5-2	100

CÓDIGO	Ø CABLE	ENVASE
15300250003Q	2,5-3	50

Medidas en mm.

1501 SUJETACABLES DIN 741

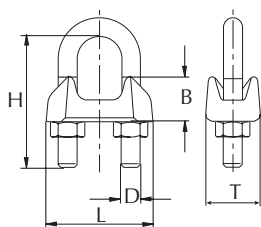

Medida	2-3	4-5	6-6,5	8	10	11	13	14	16	19	22
D	M4	M5	M5	M6	M8	M8	M10	M10	M12	M12	M14
H	16	19	23	28	34	36	45	47	51	63	71
L	21	23	26	30	34	36	42	44	50	54	61
B	10	10	11	15	17	18	21	22	26	30	34
T	10	11	12	14	18	19	23	23	26	29	33



- El sujetacable, compuesto por una horquilla y un cuerpo puente, permite hacer gazas de cables o conexiones donde no se pueda prensar ni usar terminales o uniones temporales de cables.
- Uso industrial, unión entre cable y cadena (No EPI)

CÓDIGO	MEDIDA	ENVASE
1501030000V	3	200
1501050000V	5	200
1501060000V	6	100
1501080000V	8	100
1501100000V	10	100
1501110000V	11	100

CÓDIGO	MEDIDA	ENVASE
1501130000V	13	100
1501140000V	14	50
1501160000V	16	50
1501190000V	19	25
1501220000V	22	15

1502 SUJETACABLES FORMA ESPAÑOLA

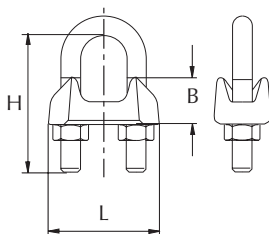

Medida	1/8"	3/16"	1/4"	5/16"	3/8"	7/16"	1/2"	9/16"	5/8"	3/4"	7/8"	1"
Ø cable	2-3	4-5	6-6,5	8	10	11	13	14	16	18	20	22
H	20	24	30	30	41	41	50	55	58	63	77	85
L	23	26	32	35	40,5	43	49	52,5	57,5	61	71	77,5
B	11	13	15	16	21,6	22	23,3	27	28	34	38	43



- Sujetacables de mayor tamaño que DIN 741, acompañado de un estriado en el cuerpo puente que permite que el agarre del cable sea mayor.
- La parte roscada de la horquilla y sus tuercas son rosca Whitworth.
- Uso industrial, unión entre cable y cadena (No EPI)

CÓDIGO	MEDIDA	ENVASE
15020010000V	1"	15
15020120000V	1/2"	100
15020140000V	1/4"	100
15020180000V	1/8"	200
15020340000V	3/4"	25
15020380000V	3/8"	100

CÓDIGO	MEDIDA	ENVASE
15020580000V	5/8"	50
15020780000V	7/8"	20
15023160000V	3/16"	200
15025160000V	5/16"	100
15027160000V	7/16"	100
15029160000V	9/16"	50

Medidas en mm.

### 1503 SUJETACABLES PLANO SIMPLE

Medida	2	3	4	5	6
Métrica	M4	M4	M5	M6	M6
L	18,5	20	21,5	26	30
B	12,6	14	17	21	25

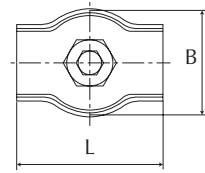

- Dispone de una placa de acero en la base que, al realizar el apriete sobre la tuerca, permite un montaje rápido, eficaz y seguro.
- La placa presiona el cable y evita que este se deslice.
- Su utilización está especialmente indicada cuando se pretenden obtener unos montajes estéticos donde las uniones queden desapercibidas.
- Uso industrial, unión entre cable y cadena (No EPI)

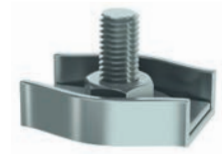

CÓDIGO	MEDIDA	ENVASE
15030200000Z	2	100
15030300000Z	3	100
15030400000Z	4	100

CÓDIGO	MEDIDA	ENVASE
15030500000Z	5	100
15030600000Z	6	50

### 1504 SUJETACABLES PLANO DOBLE

Medida	2	3	4	5	6
L	37	40	43	52	60
B	12,6	14	17	21	25

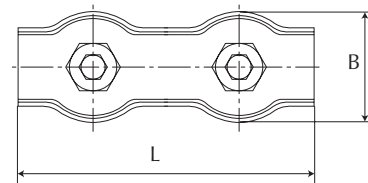

- Permite un rápido montaje e incrementa la seguridad y eficacia respecto al sujetacable simple, ya que dispone de una placa doble y dos tuercas que permiten abarcar una mayor longitud de cable.
- Su utilización está especialmente indicada cuando se pretenden obtener unos montajes estéticos donde las uniones queden desapercibidas.
- Uso industrial, unión entre cable y cadena (No EPI)

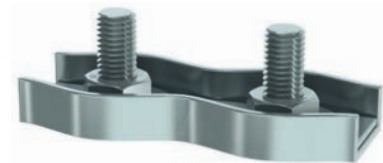

CÓDIGO	MEDIDA	ENVASE
15040200000Z	2	100
15040300000Z	3	100
15040400000Z	4	100

CÓDIGO	MEDIDA	ENVASE
15040500000Z	5	50
15040600000Z	6	50

1505 ESE GALVANIZADA

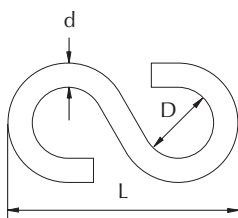

Medida	3	3,5	4	4,5	5	6	7	8	9	10
L	25	30	35	40	45	55	65	75	90	103
D	9	9	11	12	14	16	20	23	24	25



- Se trata del elemento más funcional, económico, rápido y práctico para realizar uniones con objetos generalmente previstos para ser colgados.
- Su perfecta simetría en forma de "S" y la proporcionalidad de cada longitud respecto a su correspondiente grosor garantizan una excelente seguridad de aplicación.
- Uso industrial, unión entre cable y cadena (No EPI)

CÓDIGO	MEDIDA	ENVASE
15050300000V	3	200
15050350000V	3,5	200
15050400000V	4	200
15050450000V	4,5	200
15050500000V	5	200

CÓDIGO	MEDIDA	ENVASE
15050600000V	6	100
15050700000V	7	50
15050800000V	8	50
15050900000V	9	25
15051000000V	10	25

1506 MOSQUETÓN BOMBERO

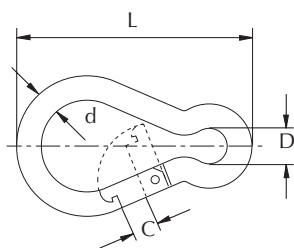

Medida	5x50	6x60	7x70	8x80	9x90	10x100	11x120	12x140	14x180
S.W.L.(kg)	100	120	180	230	250	350	400	450	580
L	50	60	70	80	90	100	120	140	180
d	5	6	7	8	9	10	11	12	14
C	7	8	8	9	10	11	16	19	35
D	8	9	10	12	12	15	18	20	22



- El diseño del gozne permite ser utilizado en montajes rápidos, en donde no esté comprometida la posible apertura de dicho elemento y en usos temporales que precisen ser retirados con continuidad o con premura.
- El perfecto acoplamiento del extremo del gozne con el vértice del cuerpo y la calidad del dispositivo de retorno garantizan su máxima seguridad y eficacia.
- Uso industrial, unión entre cable y cadena (No EPI)

CÓDIGO	MEDIDA	L	ENVASE
15060500050Z	5	50	100
15060600060Z	6	60	100
15060700070Z	7	70	100
15060800080Z	8	80	50
15060900090Z	9	90	25

CÓDIGO	MEDIDA	L	ENVASE
15061000100Z	10	100	25
15061100120Z	11	120	10
15061200140Z	12	140	10
15061400180Z	14	180	10

Medidas en mm.

1507 MOSQUETÓN BOMBERO CON SEGURO

Medida	6x60	7x70	8x80	9x90	10x100	11x120	12x140
S.W.L.(kg)	120	180	230	250	350	400	450
L	60	70	80	90	100	120	140
d	6	7	8	9	10	11	12
C	8	8	9	10	11	16	19
D	9	10	12	12	15	18	20

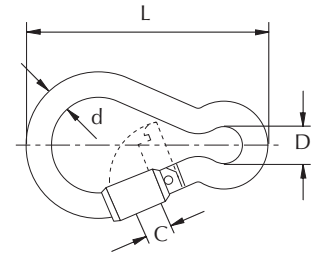

- El DIN 5299 con seguro tiene la ventaja de que su apertura por descuido, rozamiento o error queda obstaculizada por el dispositivo que actúa de seguro entre el gozne y el cuerpo del DIN 5299.
- La rosca interior del seguro garantiza la máxima firmeza del agarre, y el estriado exterior del seguro facilita la funcionalidad manual del roscado.
- Uso industrial, unión entre cable y cadena (No EPI).

CÓDIGO	MEDIDA	L	ENVASE
15070600060Z	6	60	100
15070700070Z	7	70	100
15070800080Z	8	80	50

CÓDIGO	MEDIDA	L	ENVASE
15070900090Z	9	90	25
15071000100Z	10	100	25
15071200140Z	12	140	10

1508 MALLA RÁPIDA

Medida	3,5	4	5	6	7	8	9	10	12
S.W.L.(kg)	150	160	180	650	880	1200	1700	2260	2430
L	36	39,5	48	57	66	76	83	89	107
A	17	19	23	26	30	34	37	40	49
B	5	5,5	6,5	7,5	8	10	11	12	15

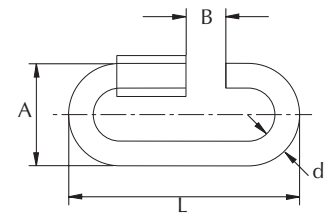

- La malla rápida es un tipo de eslabón muy eficaz para conseguir uniones rápidas de cadenas.
- La forma hexagonal externa combinada con el roscado interno del dispositivo de cierre garantiza una perfecta funcionalidad y una óptima seguridad de aplicación.
- Uso industrial, unión entre cable y cadena (No EPI).

CÓDIGO	MEDIDA	ENVASE
15080350000Z	3,5	100
15080400000Z	4	100
15080500000Z	5	100
15080600000Z	6	100
15080700000Z	7	50

CÓDIGO	MEDIDA	ENVASE
15080800000Z	8	50
15080900000Z	9	25
15081000000Z	10	25
15081200000Z	12	25

1510 GIRATORIO - QUITAVUELTAS

Medida	6	8	10
A	15	20	24
B	65	90	115
C	14	21	25

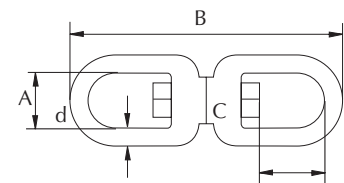

- Las anillas giratorias, están especialmente indicadas para aplicaciones donde la elevación de cargas, elementos a transportar o amarrar, precisen de movimientos direccionales opuestos entre ambos extremos evitando las anillas giratorias que la cadena o cabo se retuercen.
- Uso industrial, unión entre cable y cadena (No EPI).

CÓDIGO	MEDIDA	ENVASE
15100600000Z	6	50
15100800000Z	8	50

CÓDIGO	MEDIDA	ENVASE
15101000000Z	10	50

Medidas en mm.

1509 TENSOR JARDINERA

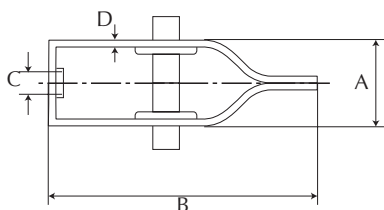

Medida	80x26
A	26
B	80
C	5,5
D	2



- Es la respuesta idónea para el tensado de los vallados con telas metálicas.
- Los 80 kg de carga de trabajo recomendada garantizan una excelente aplicación (300 kg resistencia de rotura).
- Para obtener un óptimo tensado debe reapretarse el pasador después del tensado sin sobrepasar la carga de trabajo recomendada.
- Uso industrial, unión entre cable y cadena (No EPI).

CÓDIGO	MEDIDA	ENVASE
15092600080Z	26 x 80	250

1511 GRILLETE RECTO GALVANIZADO

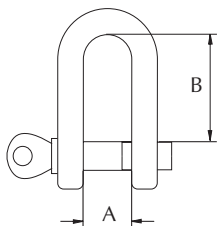

Medida	5	6	8	10	12	14	16	18	19	22	24	28	32	38	42
S.W.L.(kg)	80	100	200	320	520	650	800	1000	1100	1500	2100	3000	3500	5000	8000
A	10	12	16	20	25	28	32	36	38	44	50	56	64	76	76
B	19	24	32	40	48	56	64	71	76	85	95	106	120	145	145
Ø bulón	5	6	8	10	12	14	16	18	19	22	25	28	32	38	42



- El grillete recto es el instrumento de elevación que más frecuentemente se utiliza como pieza intermedia entre una anilla, cáncamo o gancho y una eslinga.
- El diseño de la cabeza del bulón y su conexión con el arco mediante una rosca facilita el montaje dentro de la estructura de elevación precisada en cada momento.
- Para realizar un montaje correcto, el gancho siempre tiene que ir sujetado en el bulón del grillete y la eslinga, cable o cabo deben ir agarrados en el arco del grillete.
- Nunca debe efectuarse el montaje de manera inversa.
- Uso industrial, unión entre cable y cadena (No EPI).

CÓDIGO	MEDIDA	ENVASE
15110500000V	5	50
15110600000V	6	50
15110800000V	8	50
15111000000V	10	50
15111200000V	12	25
15111400000V	14	25
15111600000V	16	10
15111800000V	18	5

CÓDIGO	MEDIDA	ENVASE
15111900000V	19	5
15112200000V	22	1
15112400000V	24	1
15112800000V	28	1
15113200000V	32	1
15113800000V	38	1
15114200000V	42	1

Medidas en mm.

1512 TENSOR GANCHO-ANILLA DIN 1480

Medida	M5	M6	M8	M10	M12	M14	M16	M20	M22	M24	M27	M30	M32	M36
Medida equiv.	3/16"	1/4"	5/16"	3/8"	1/2"	9/16"	5/8"	3/4"	7/8"	1"	11/16"	11/4"	15/16"	11/2"
S.W.L.(Kg)	60	75	135	200	265	365	600	800	1100	1335	1665	2000	2235	2665
A	7	8	10,5	13	16	18	20	21	24	26	34	34	38	46
B	70	110	110	125	125	140	170	200	220	255	255	255	295	295
C	16	20	22	31	35	40	47	52	60	65	70	70	88	94
D	57	80	85	105	111	124	150	168	190	212	224	224	245	277
E	56	77	85	106	117	124	144	170	200	215	240	240	260	275

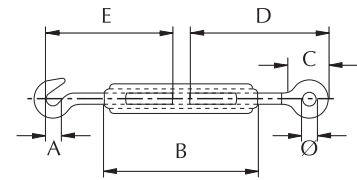

- Es la combinación más universal, por lo que a terminales de tensor se refiere, debido a la seguridad que comporta el ensamblaje del cable en la anilla y a la rapidez de la unión a la aplicación mediante el gancho.
- Uso industrial, unión entre cable y cadena (No EPI).



CÓDIGO	MEDIDA	ENVASE
15120500000Z	M5	50
15120600000Z	M6	50
15120800000Z	M8	25
15121000000Z	M10	25
15121200000Z	M12	10
15121400000Z	M14	10
15121600000Z	M16	10

CÓDIGO	MEDIDA	ENVASE
15122000000Z	M20	5
15122200000Z	M22	1
15122400000Z	M24	1
15122700000Z	M27	1
15123000000Z	M30	1
15123200000Z	M32	1
15123600000Z	M36	1

1513 ANILLA ELEVACIÓN MACHO DIN 580

Medida	M6	M8	M10	M12	M14	M16	M18	M20	M22	M24	M27	M30	M36	M42
S.W.L.(kg)	90	140	230	340	500	700	930	1200	1500	1800	2500	3600	5100	7000
D1	36	36	45	54	63	63	72	72	81	90	96	108	126	144
D2	20	20	25	30	35	35	40	40	45	50	53	60	70	80
H	13	13	17	20,5	27	27	30	30	35	36	39	45	54	63
L	36	36	45	53	62	62	71	71	80,5	90	97	109	128	147

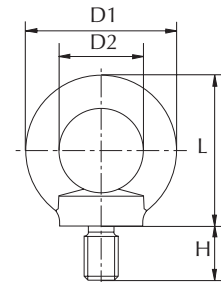

- La anilla de elevación macho está especialmente indicada cuando la carga a elevar o amarrar, dispone de una superficie física perfectamente plana.
- La anilla de elevación macho es unida a la parte a elevar o amarrar mediante el espárrago roscado de la propia anilla, garantizando así la perfecta unión entre las dos partes y su posterior seguridad en la elevación o amarrado de la carga.
- Uso industrial, unión entre cable y cadena (No EPI).



CÓDIGO	MEDIDA	ENVASE
15130600000Z	M6	100
15130800000Z	M8	100
15131000000Z	M10	100
15131200000Z	M12	50
15131400000Z	M14	50
15131600000Z	M16	50
15131800000Z	M18	50

CÓDIGO	MEDIDA	ENVASE
15132000000Z	M20	25
15132200000Z	M22	25
15132400000Z	M24	25
15132700000Z	M27	10
15133000000Z	M30	10
15133600000Z	M36	1
15134200000Z	M42	1

Medidas en mm.

1514 ANILLA ELEVACIÓN HEMBRA DIN 582

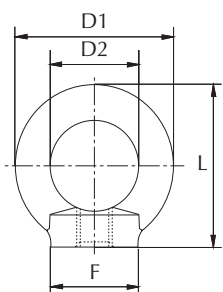

Medida	M6	M8	M10	M12	M14	M16	M18	M20	M22	M24	M27	M30
S.W.L.(kg)	90	140	230	340	500	700	930	1200	1500	1800	2500	3600
D1	36	36	45	54	63	63	72	72	81	90	96	108
D2	20	20	25	30	35	35	40	40	45	50	53	60
F	20	20	25	30	35	35	40	40	45	50	55	65
L	36	36	45	53	62	62	71	71	80,5	90	97	109



- La anilla de elevación hembra está especialmente indicada cuando la carga a elevar o amarrar, dispone de una superficie física perfectamente plana.
- La anilla de elevación hembra es unida a la parte a elevar o amarrar mediante un espárrago que es introducido dentro de la parte roscada de la propia anilla, garantizando así la propia unión entre las dos partes y su posterior seguridad en la elevación o amarrado de la carga. Uso industrial, unión entre cable y cadena (No EPI).

CÓDIGO	MEDIDA	ENVASE
1514060000Z	M6	100
1514080000Z	M8	100
1514100000Z	M10	100
1514120000Z	M12	100
1514140000Z	M14	50
1514160000Z	M16	50

CÓDIGO	MEDIDA	ENVASE
1514180000Z	M18	50
1514200000Z	M20	50
1514220000Z	M22	25
1514240000Z	M24	25
1514270000Z	M27	10
1514300000Z	M30	10

1515 ANILLA TENSOR

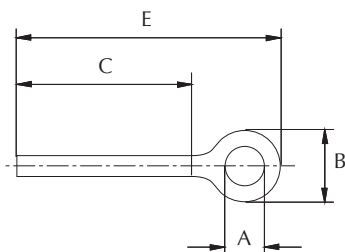

Medida	M5	M6	M8	M10	M12	M14
Medida equiv.	3/16"	1/4"	5/16"	3/8"	1/2"	9/16"
A	8	9	10	14	16	18
B	16	20	22	31	35	40
C	35	55	57	68	70	75
E	57	80	85	105	111	124



- Indicado para montaje sobre un cuerpo tensor DIN 1480 o DIN 1478 y recomendado para aplicaciones donde el extremo a fijar sea un gancho.
- Uso industrial, unión entre cable y cadena (No EPI).

CÓDIGO	MEDIDA	ENVASE
1515050000Z	M5	100
1515060000Z	M6	100
1515080000Z	M8	100

CÓDIGO	MEDIDA	ENVASE
1515100000Z	M10	50
1515120000Z	M12	50
1515140000Z	M14	25

Medidas en mm.



1516 TRINCAJES

Medida	Carga ligera	
	500x2,5	700x5
Ancho cinta	25	35
Longitud (m)	2,5	5
C.M.U. (kg)	500	700



- Trincajes para cargas ligeras y pesadas.
- Siempre se debe de asegurar que la carga real para amarrar es la correcta para el trincaje empleado.
- Uso industrial, unión entre cable y cadena (No EPI).

CÓDIGO	MEDIDA	ENVASE
15160250500Z	2,5	2

CÓDIGO	MEDIDA	ENVASE
15160500700Z	5	1

Medida	Carga pesada		
	800x5	2000x6	5000x9
Ancho cinta	25	35	50
Longitud (m)	5	6	9
C.M.U. (kg)	800	2000	5000



- Trincajes para cargas ligeras y pesadas.
- Siempre se debe de asegurar que la carga real para amarrar es la correcta para el trincaje empleado.
- Uso industrial, unión entre cable y cadena (No EPI).

CÓDIGO	MEDIDA	ENVASE
15160500800B	5	1
15160602000B	6	1

CÓDIGO	MEDIDA	ENVASE
15160905000B	9	1

1517 GUARDACABOS

Medida	3	4	5	6	8	10	12	13	15	18	20	24
Ancho interior	4	5	6	7	9	11	13	14	16	20	22	26
A	12	13	14	15	18	22	26	28	32	40	44	48
B	26,5	28,5	30	33	39	47,5	56,5	61	69,5	86,5	95	105

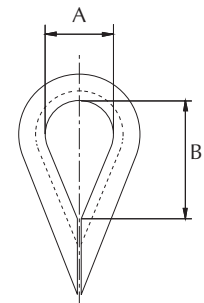

- El guardacabo es un elemento imprescindible para garantizar la protección del cable en el momento de producirse cualquier tipo de rozadura o fricción.
- El alineado perfecto y sin fisuras de las aristas externas, y la profundidad del surco garantizan el perfecto asentamiento del cable.
- Uso industrial, unión entre cable y cadena (No EPI).



CÓDIGO	Ø CABLE	ENVASE
15170300000Z	3	200
15170400000Z	4	200
15170500000Z	5	200
15170600000Z	6	200
15170800000Z	8	100
15171000000Z	10	100

CÓDIGO	Ø CABLE	ENVASE
15171200000Z	12	100
15171300000Z	13	50
15171500000Z	15	50
15171800000Z	18	50
15172000000Z	20	25
15172400000Z	24	10

Medidas en mm.

1518 GANCHO ELEVACIÓN CON SEGURO

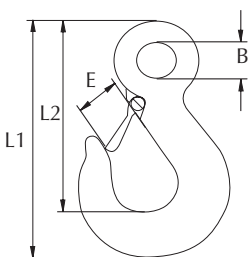

Medida / S.W.L.(kg)	250	500	750	1000	2000	4500
L1	89	118	82	93	119	146
B	12	16	19	23	32	39,5
E	12	21	24	26	31	34



- La calidad del muelle activador del seguro le confiere una funcionalidad rápida sin alterar la seguridad que debe comportar el proceso de elevación o desplazamiento de cargas.
- Cada gancho lleva marcado sobre relieve su correspondiente carga de trabajo en toneladas y con el símbolo identificativo del tipo de material: (C) para los ganchos de acero al carbono y (A) para los ganchos de acero aleado, quedando garantizada su elección.
- Acero C15.
- Uso industrial, unión entre cable y cadena (No EPI).

CÓDIGO	MEDIDA/CARGA KG.	ENVASE
15180000250V	250	25

CÓDIGO	MEDIDA/CARGA KG.	ENVASE
15180000500V	500	25



CÓDIGO	MEDIDA/CARGA KG.	ENVASE
15180000750J	750	10
15180001000J	1000	10

CÓDIGO	MEDIDA/CARGA KG.	ENVASE
15180002000J	2000	5
15180004500J	4500	1

1519 GANCHO AUTOCIERRE GRADO 80

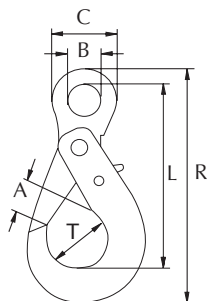

Medida	1200	2000	3200	5400
S.W.L.(kg)	1120	2000	3200	5400
A	31	38	52	62
B	23	25	31,5	39,5
C	44	46,5	62,5	80,5
R	106	134	168	209
L	137,5	169	219	269
T	34,5	44	58	67

- El gancho de autocierre es el adecuado para usarse con cadenas grado 80.
- El dispositivo de autocierre permite obtener la máxima garantía por lo que a seguridad se refiere.
- La propia fuerza de tracción de la carga impide su apertura accidental.
- En el modelo con horquilla y pasador, este facilita la movilidad direccional de la carga.
- Uso industrial, unión entre cable y cadena (No EPI).

CÓDIGO	MEDIDA/CARGA KG.	ENVASE
15190001200J	1200	1
15190002000J	2000	1

CÓDIGO	MEDIDA/CARGA KG.	ENVASE
15190003200J	3200	1
15190005400J	5400	1

Medidas en mm.

The image features several industrial chains of different colors and orientations against a white background. A thick black chain is draped across the middle. Two thinner silver chains hang vertically on the left and right sides. A thin blue chain hangs vertically in the center, passing through the black chain. The text is centered at the bottom of the image.

**NUEVA GAMA  
DE CADENA  
INDUSTRIAL**